

Toilet Air
Art. Nr. 2850600
1/7

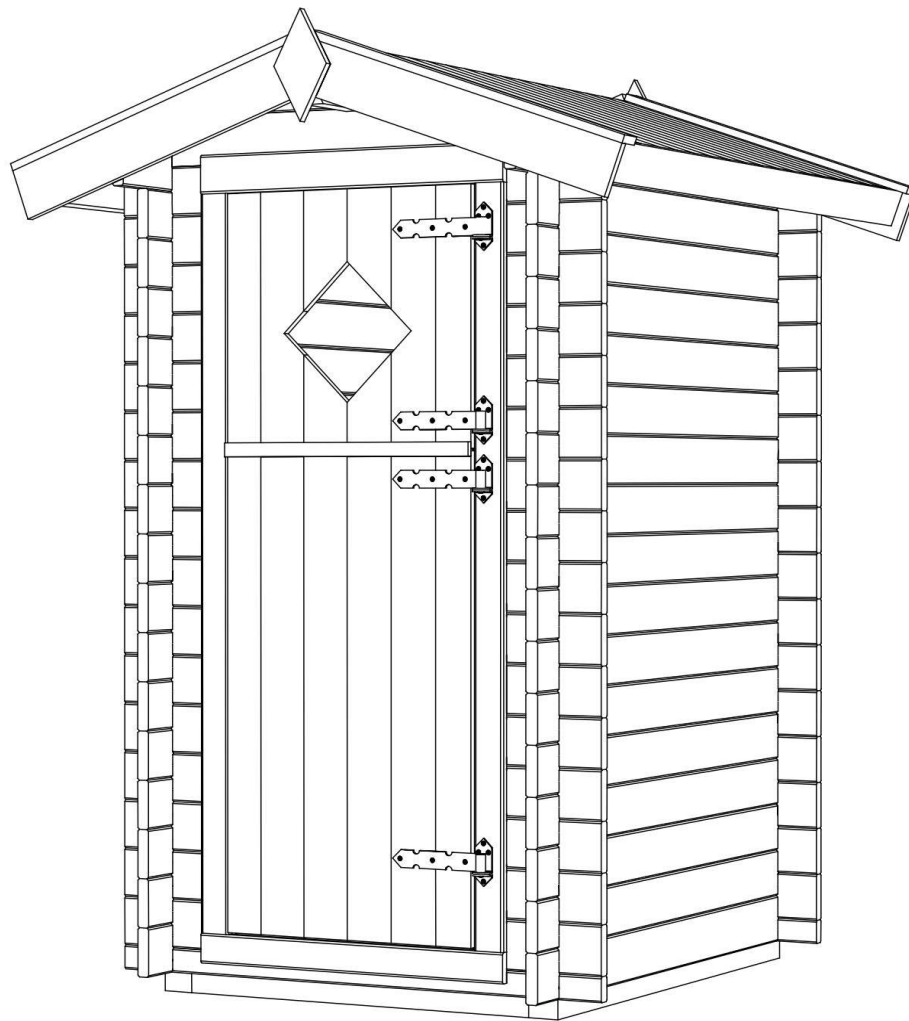

Groundplan - Grundplan - Plan de masse - Planimetria -
Plattegrond - Põhiplaan

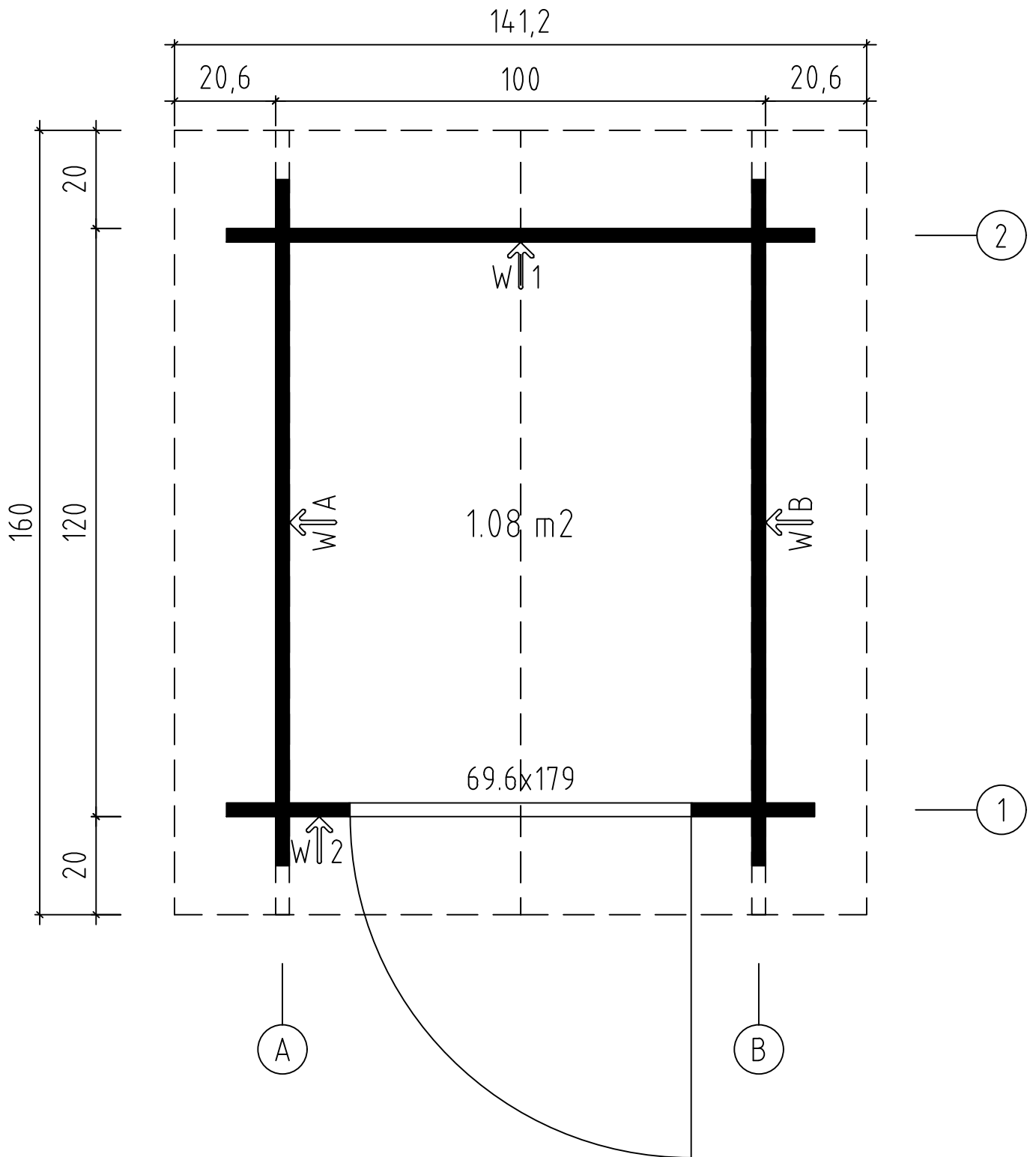

Art. Nr. 2850600

Foundation - Fundament - Fondation - Fundamenta -
Fundering - Immutatud alusraam

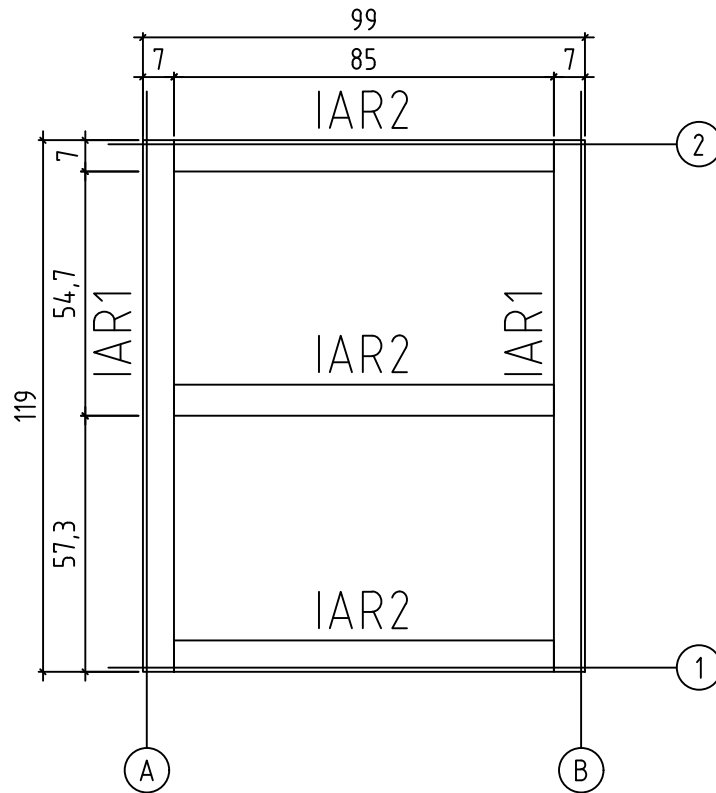

Floor boards - Fussbodenbretter - Plan pose plancher -
Pavimento - Vloerhout - Põrandalaudis

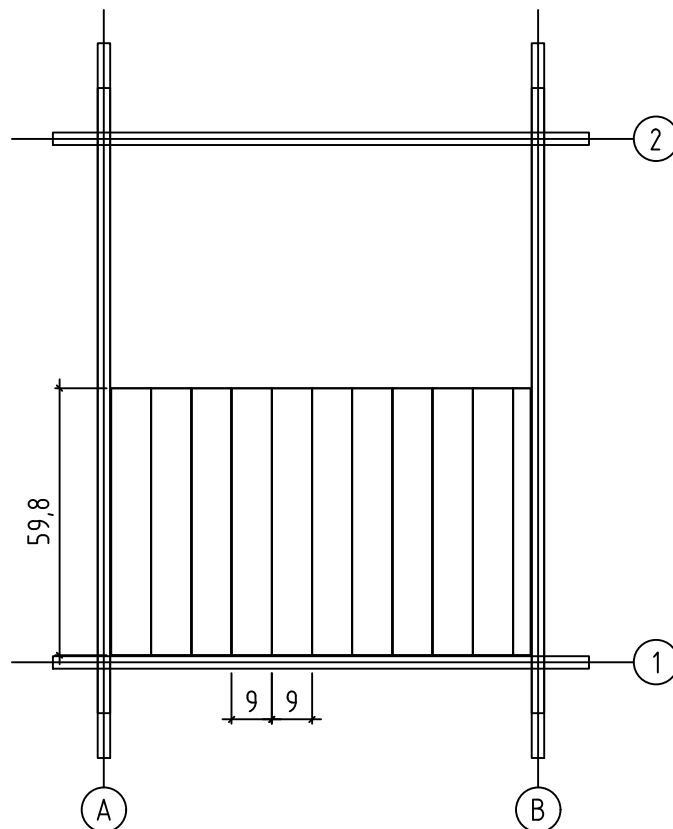



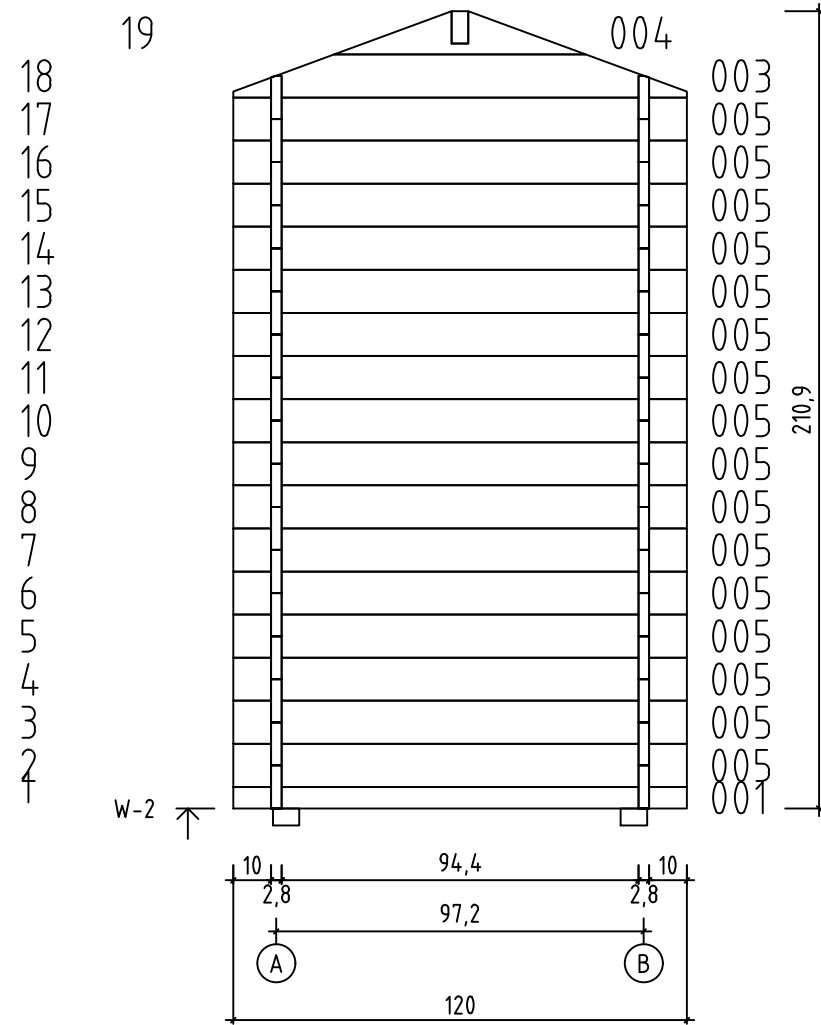
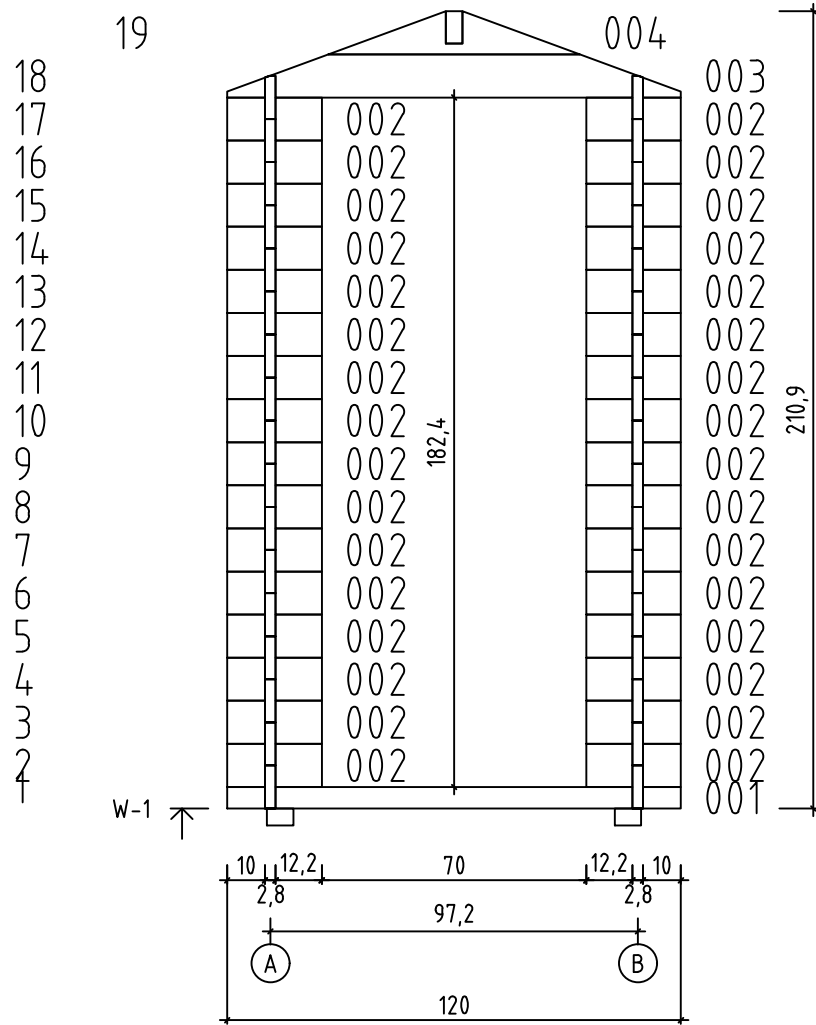



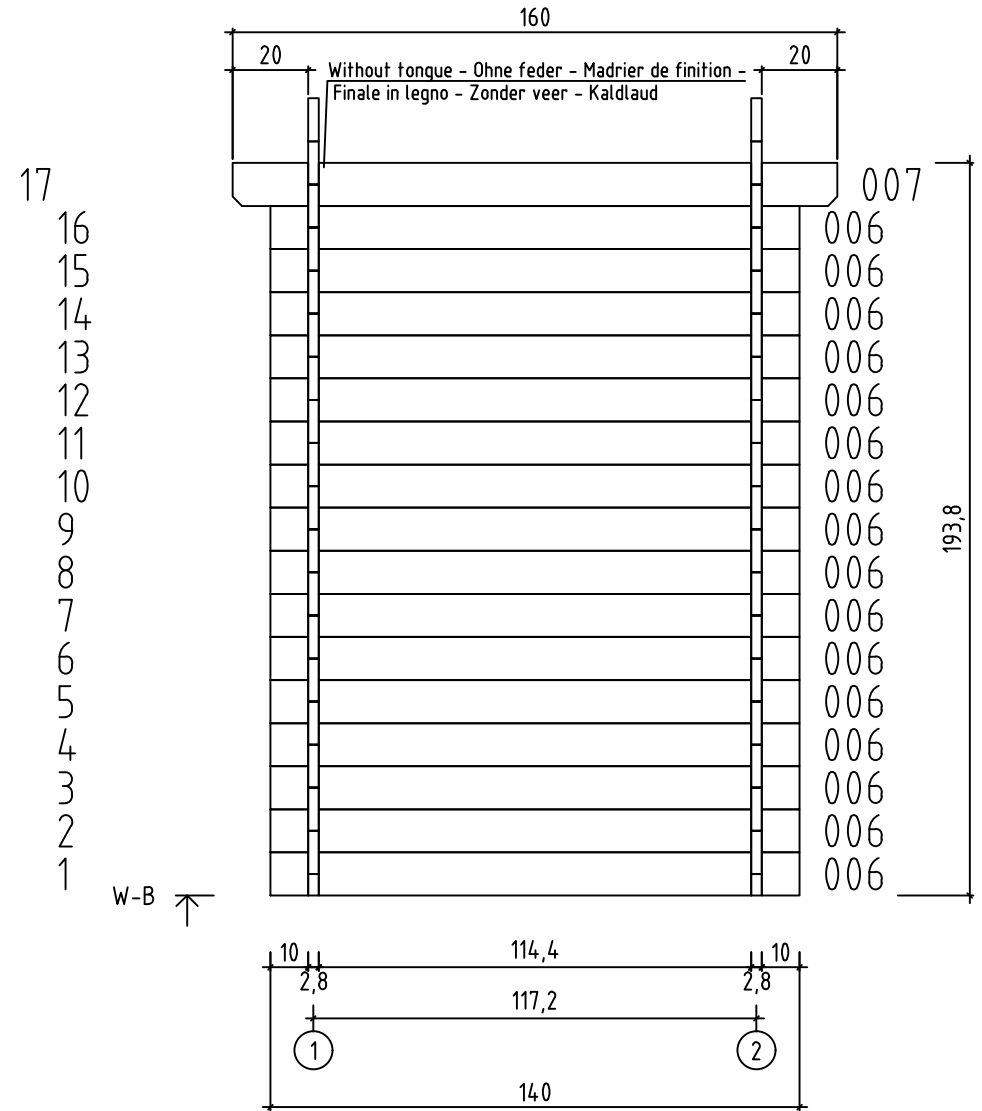
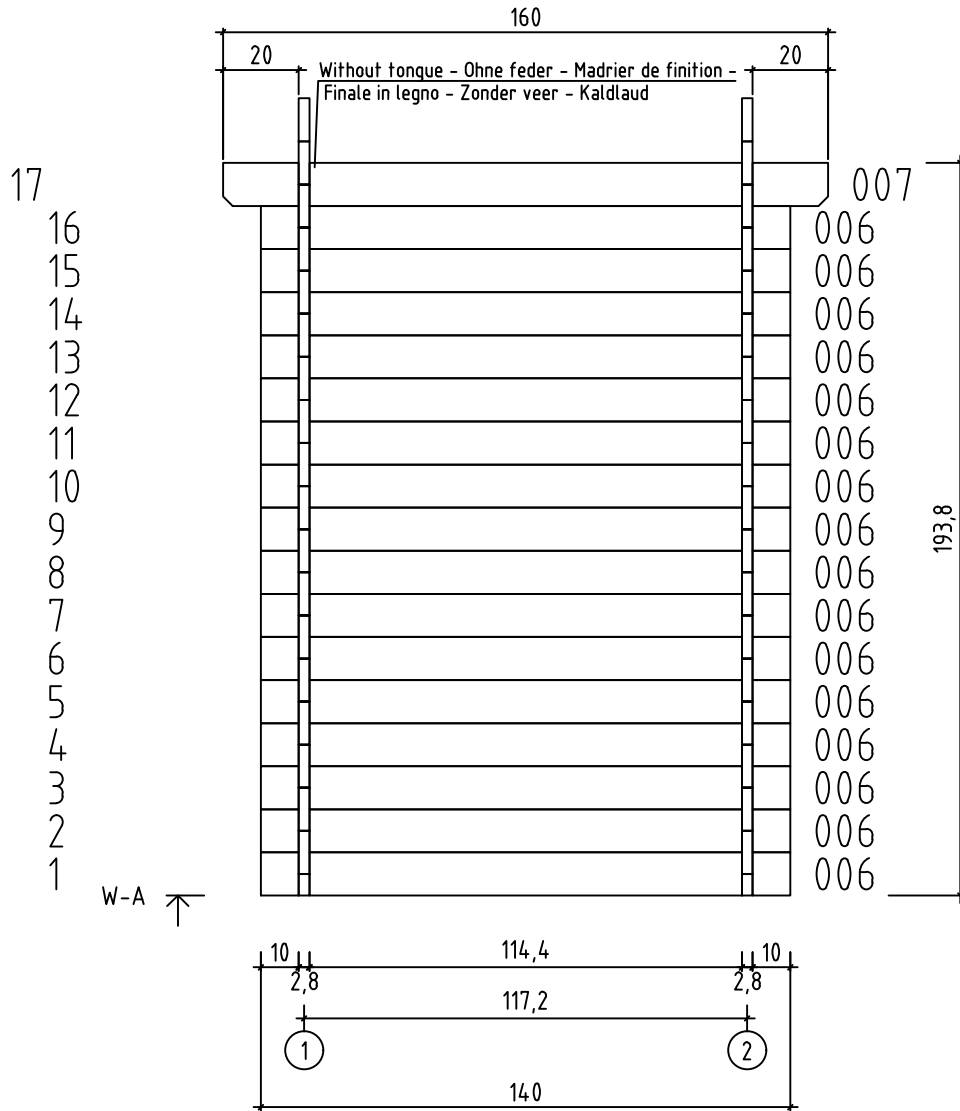

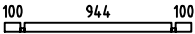

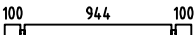
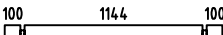
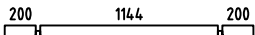
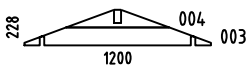
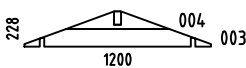

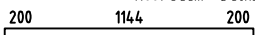





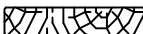

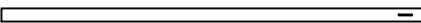
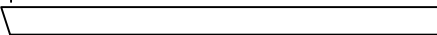
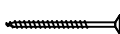
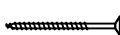

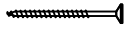
Art. Nr. 2850600



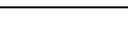
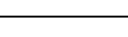
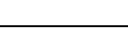



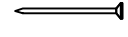
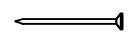
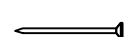
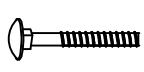

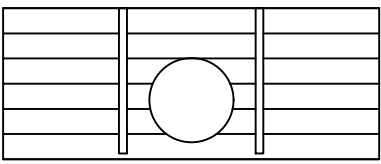

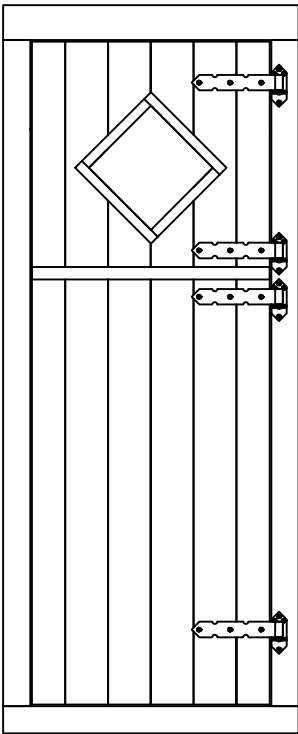
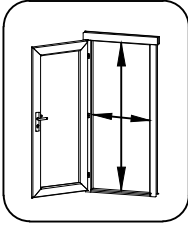
Art. Nr. 2850600

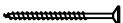
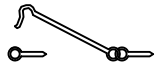
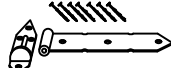

Pos	04.12.2020 Piece list - Stückliste - Liste des pièces - Elementi - Stuklijst - Tükitalabel Art. Nr. 2850600 6/7	Q	P (mm)	L (mm)
001		2	28x57	1200
002		32	28x114	250
005		16	28x114	1200
006		32+1	28x114	1400
007		2	28x120	1600
W1-1		1		
W2-1		1		
IAR1	Foundation - Fundament - Fondation - Fondamenta - Fundering - Immutatud alusraam 	2	70x45	1190
IAR2	Foundation - Fundament - Fondation - Fondamenta - Fundering - Immutatud alusraam 	3	70x45	850
A-PR1	Roof beam - Dachbalken - Panne de toit - Perlina del tetto - Gordingen / dakbalk - Pärilin 	1	44x120	1600
	Floor boards - Fussbodenbretter - Lame de plancher - Pavimento - Vloerhout - Põrandalaud 	11	90x18	598
TB-1	Roof boards - Dachbretter - Voliges - Perlina per tetto - Dakhout - Katuselaud 	36	90x18	750
	Floor fillet - Fussbodenleiste - Corniere de finition du plancher - Finitura per pavimento (battisco pa) - Vloerafwerklijt - Põrandaliist 		18x18	4
E1	Roof boards - Dachbretter - Voliges - Perlina per tetto - Dakhout - Katuselaud 	4	18x90	940
E1	Roof boards - Dachbretter - Voliges - Perlina per tetto - Dakhout - Katuselaud 	1	18x90	940
	Roofing felt fillet - Dachpappenleiste - Baguette de fixation du feutre bitumeux - Asse per fissaggio guaina bituminosa - Afdeklijst asfaltpapier - Katusepapiiist 	4	18x58	800
TB-1	Fascia board - Traufbrett - Bandeau de toit - Finitura lati tetto - Gevellijst - Räästalaud 	2	18x90	1600
DRV-1	Roof edge reinforcement - Dachrandverstärkung - Corniere de renfort de bord de toit - Rinforzo x tetto - Dakrand versterking - Räästafugevdus 	2	28x34	1600
	Assembly batten - Montagelatte - Baguettes de maintien, nécessaires a la mise en place des panneaux de toit - Battente di montaggio - Montage lat - Montaažilatt 	6	28x34	450
KFS-1	Storm protection - Sturmleiste - Latte anti-tempete - Protezione anti vento - Stormverankering / beveiliging - Tormikinnitusliist 	4	22x45	2050
	Gable moulding - Giebelleiste - Planche de rive - Finitura per frontale e retro del tetto - Gevellijst - Viilulaud 	4	18x120	800
HS8	Screw for gable segment - Schrauben für deckblatt - Vis pour fixation losange de finition - Viti x frontali tetto - Schroef voor gevelpunt segment - Kruvi rombile 	4	3.5x35	
HS9	Screw for gable moulding - Schrauben für giebelleiste - Vis pour fixation planche de rive - Vite per fissare finiture davanti e dietro del tetto - Schroef voor gevellijst - Kruvi viilulauale 	16	3.5x50	

Pos	04.12.2020 Piece list - Stückliste - Liste des pièces - Elementi - Stuklijst - Tükítabel Art. Nr. 2850600 7/7	Q	P (mm)	L (mm)
HS12	Screw for fascia boards - Schrauben für traufbretter - Vis pour fixation bandeau de toit - Viti x striscia del tetto - Schroef voor gevellijst - Kruvi räästalaualae 	8	4x40	
HS12	Screw for roof edge reinforcement - Schrauben für dachrandverstärkung - Vis pour fixation corniere renfort de bord de toit - Viti x rinforzo bordo tetto - Schroef voor dakrand versterking - Kruvi räästatugevdusele 	8	4x40	
HS12	Screw for pos. E3 - Schrauben für pos. E3 - Vis pour pos. E3 - Viti per fissare elemento vedi figura in pos. n. E3 - Schroef voor pos. E3 - Kruvi pos. E3 	46	4x40	
HS18	Screw for foundation - Schrauben zur befestigung fundament - Vis de fixations des poutrelles de fondations - Viti x fondamenta - Schroef voor fundering - Kruvi alusraamile 	6	5x120	
HS18	Screw for roof beams - Schrauben für dachbalken - Vis pour fixation pannes de toit - Viti per perline del tetto - Schroef voor gordingen / dakbalken - Kruvi pärlinitale 	2	5x120	
HS18	Screw for gable - Schrauben für giebel - Vis pour fixation des pignons - Viti per timpano - Schroef voor gevelpunt - Kruvi viilude kinnitamiseks 	4	5x120	
HS16	Screw for 1. wall beam - Schraube für 1. bohlenreihe - Vis de fixations 1ere rangée de madriers avec poutrelles de fondations - Vite fissaggio alle fondamenta - Schroef voor 1 wandbalk - Kruvi poollauale 	4	5x90	
NF2	Zn nail for floor fillet - Zn nägel für fussbodenteiste - Pointe pour corniere de finition du plancher - Chiodi x fissaggio pavimento - Spijker(nagel) voor vloer afdekljst - Nael põrandaliistule 	7	1.4x40	
SH28	Hammer block - Schlagholz - Calle de frappe - Blocco di legno da usare come cuscinetto quando si usa il martello - Slagklos - Löögiklots 	1		
SFS	Nut for storm protection - Schraubenmutter für sturmleiste - Ecrou pour latte anti-tempete - Dado x asta protezione vento - Moer voor stromverankering - Mutter tormikinnitusliistule 	8	D6	
NF4	Zn nail for roof - Zn nägel für dachbretter - Pointe pour fixation voliges de toit - Chiodi x perline tetto - Spijker(nagel) voor dakhout - Nael katuselauale 	80	2x50	
NF4	Zn nail for floor - Zn nägel für fussbodenbretter - Clous pour plancher - Chiodi x perline pavimento - Spijker(nagel) voor vloer - Nael põrandalaualae 	24	2x50	
NF5	Zn nail for roofing felt fillet - Zn nägel für dachpappenleiste - Pointe pour baguette de fixation feutre bitumeux - Chiodi x carta bituminosa x tetto - Spijker(nagel) voor asfaltpapier afdekljst - Papiliistunael 	12	2x40	
BFS	Bolt for storm protection - Bolzen für sturmleiste - Boulon pour latte anti-tempete - Bullone x asta protezione vento - Bout voor stormankerlat - Puidupolt tormikinnitusliistule 	8	6x60	
GS	Gable segment - Deckblatt - Losange de finition - Decorazione in legno x frontale tetto - Gevelpunt segment - Romb 	2		
DFS	Washer for storm protection - Dichtscheibe für sturmleiste - Rondelle pour latte anti-tempete - Rondella x asta protezione vento - Afdichtring voor storm strip - Seib tormikinnitusliistule 	8	D6	
E3	1340x540 	1	1340x540	
	Door - Tür - Porte - Porte - Deur - Uks 696x1790 UK.2.020.XVP.M TZ	1		

Pos	04.12.2020	Piece list - Stückliste - Liste des pièces - Elementi - Stuklijst - Joonis 696x1790 UK.2.020.XVP.M TZ	9/9	Q	P (mm)	L (mm)
		  <p>596x1690</p>				
		Door jamb - Türrahmen - Cadre de porte - Telaio della porta - Deurframe - Ukse leng		2	66x82	1790
		Door jamb - Türrahmen - Cadre de porte - Telaio della porta - Deurframe - Ukse leng		2	66x82	760
		Fillet - Leiste - Lattes - Massello - Lijst - Liist		2	15x25	276
		Fillet - Leiste - Lattes - Massello - Lijst - Liist		2	15x25	226
HS16		Screw for door jamb - Schraube für türrahmen - Vis de fixation partie haute avec montants du cadre de porte - Viti x fissaggio montanti porte - Schroef voor deurkozijn - Krugi ukse lengile		4	5x90	
		Shutter hook - Feststeller fensterläden - Arrêts de vents pour volets - Gancio dell'otturatore - Luiken vergrendeling - Luugihaak		2		
TT		Door hinges - Torriegel - Gonds de porte - Cerniere - Deur scharnier - T-hing		4		
		Door knob - Tür-knopf - Poignée de porte - Maniglia a monopola - Deur knop - Uksenupp		1		
HS2		Screw for window fillet - Schraube für glastleiste - Vis de fixation d'encadrement vitrage - Vite per assemblaggio finestra - Schroef voor glaslijst - Krugi klaasiliistule		8	2.5x25	
FS4		Latch - Verriegeln - Loquet - Scrocco - Nachtslot - Riiv		2		