

Date rev. Description

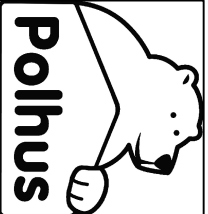

House	P3939-16 Sylvia	Sheet	1A
Drawing	Eave boards view	Scale	1:35
Material		Date	17.07.2014
Drawer		File	P3939-16 Sylvia.dwg

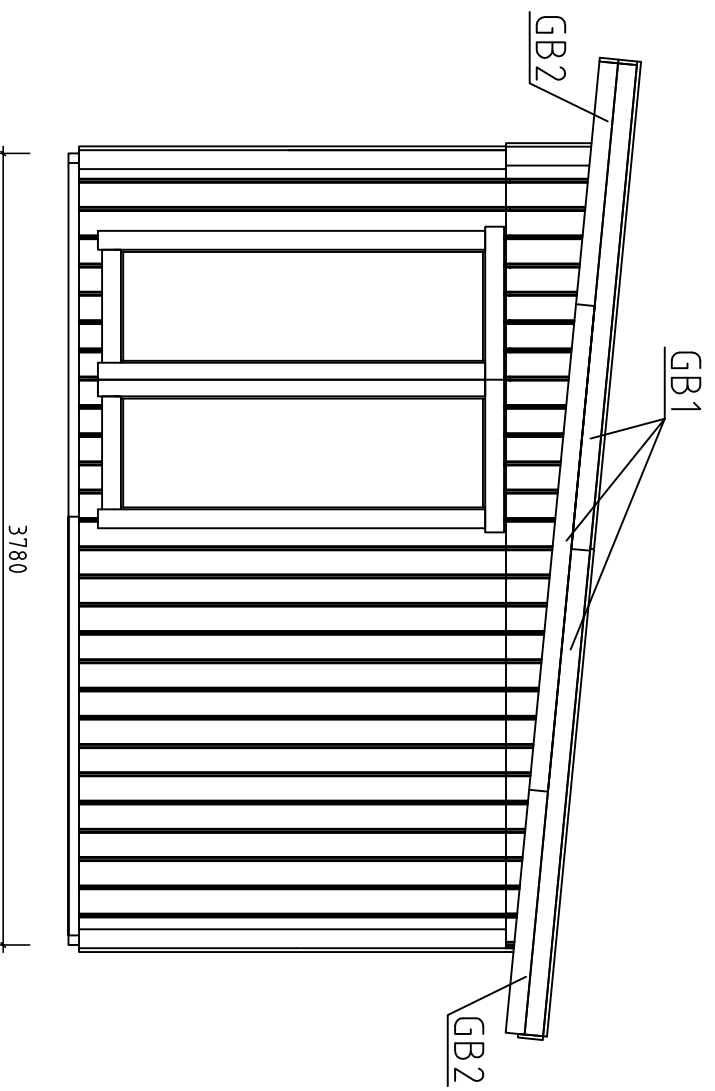

Date rev. Description

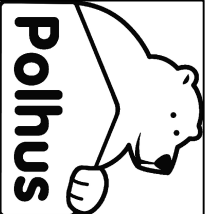

House	P3939-16 Sylvia	Sheet	1B
Drawing	Gable boards view	Scale	1:35
Material		Date	17.07.2014
Drawer		File	P3939-16 Sylvia.dwg

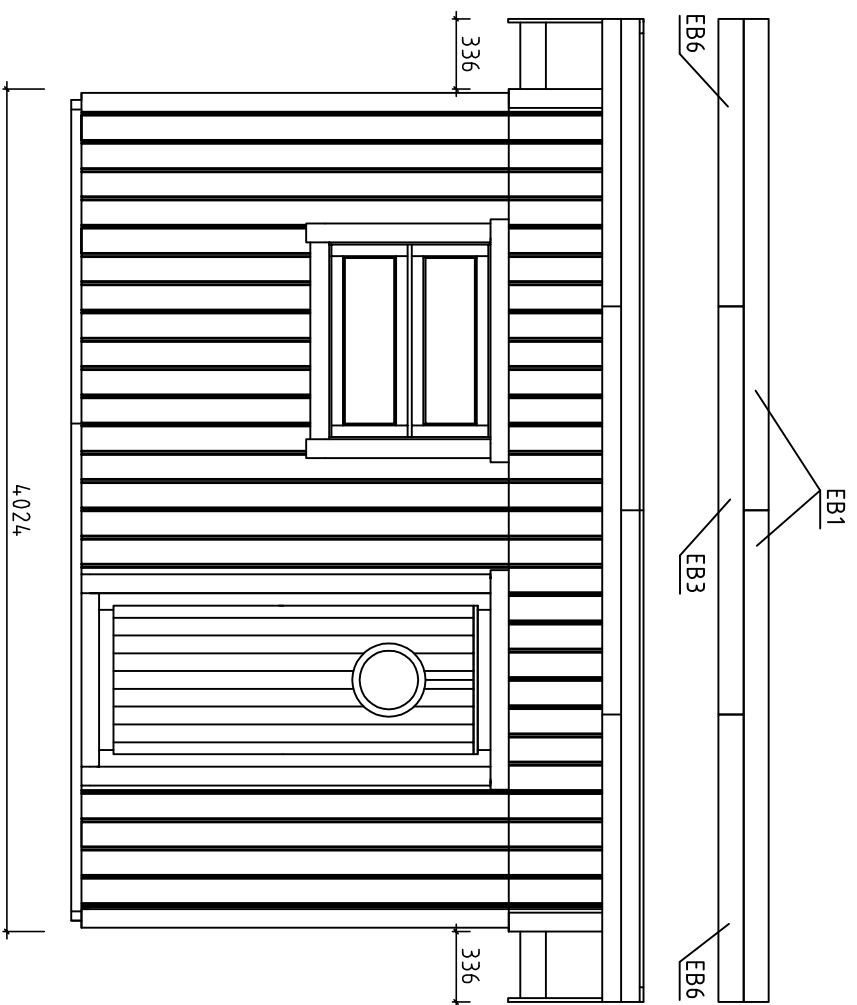

Date rev. Description

House	P3939-16 Sylvia	Sheet	1C
Drawing	Eave boards view	Scale	1:35
Material		Date	17.07.2014
Drawer		File	P3939-16 Sylvia.dwg

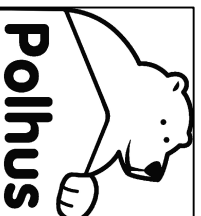

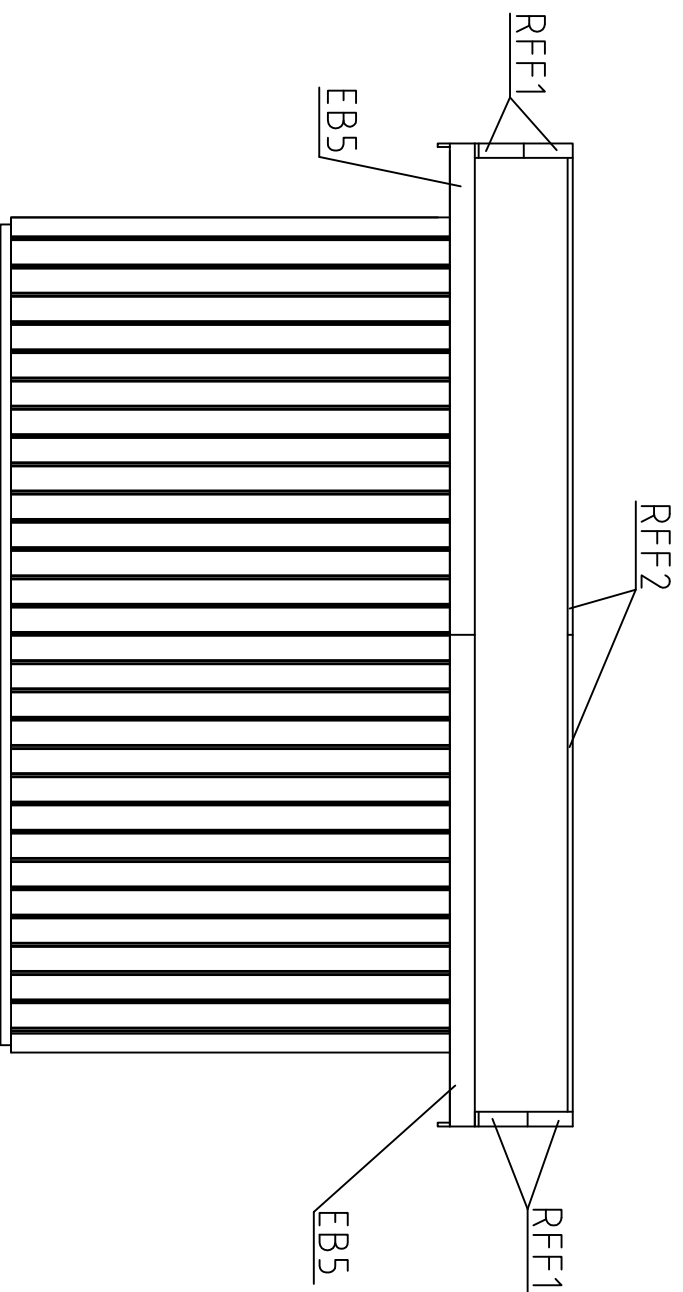

Date    rev.    Description

House	P3939-16 Sylvia	Sheet	1D
Drawing	Eave boards view	Scale	1:35
Material		Date	17.07.2014
Drawer		File	P3939-16 Sylvia.dwg

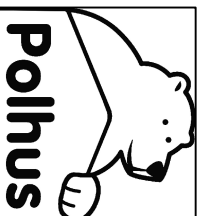

# Overview description of the manual - Översikts beskrivning för montering - Kokoonpano - ohjeiden kuvaminen

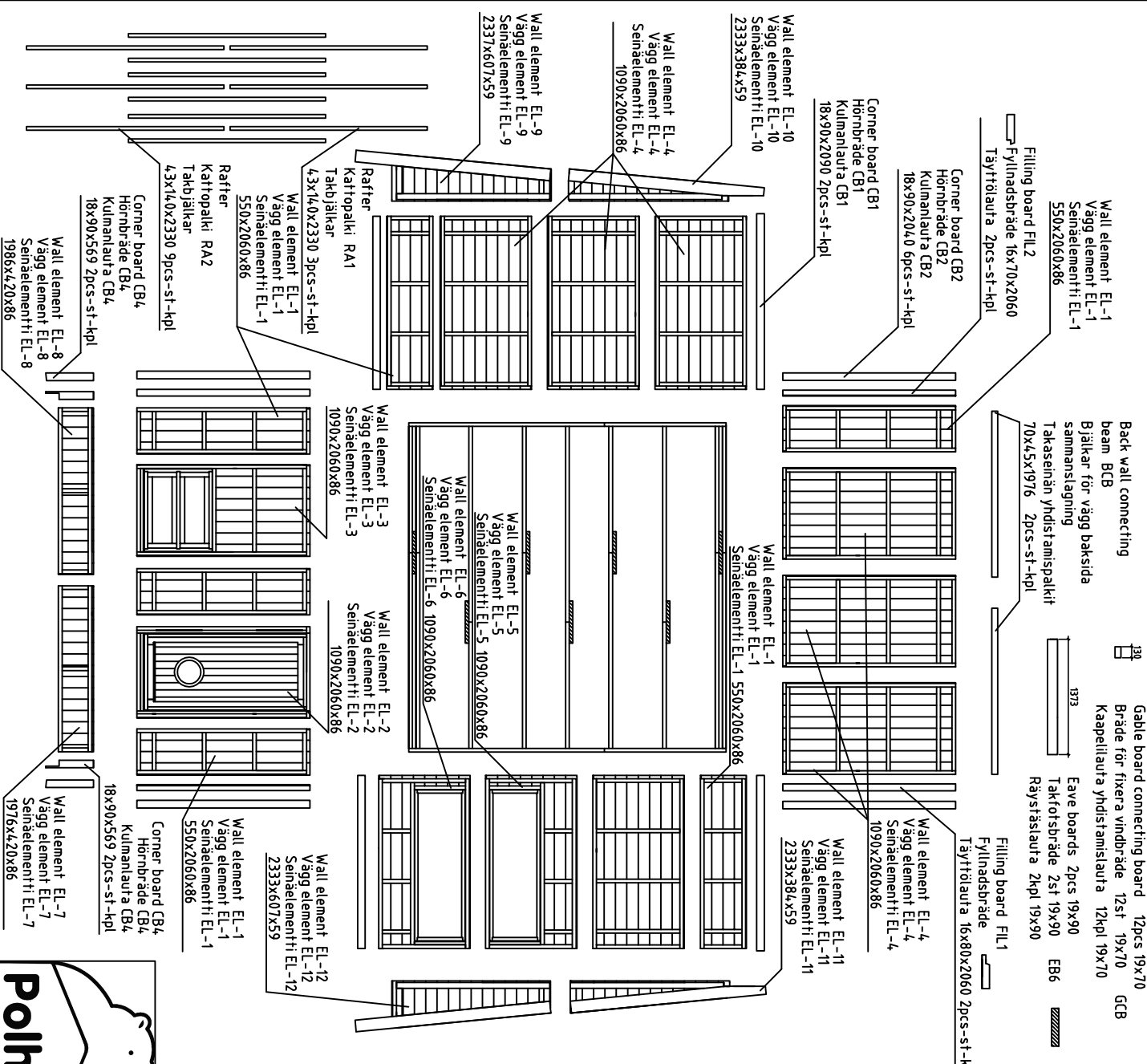

2330	1950	1355	2330	1900	2330	1165	2330	2339	2278	2348	1976	1950	2348
Roofboard 42pcs (19x114) or 54pcs (19x88)	Takbräde 42st (19x114) och 54st (19x88)	Kattförläuta 42kpl (19x114) tai 54kpl (19x88)	Floorboard 34pcs (19x114) or 43pcs (19x88)	Golvbräde 34st (19x114) och 43st (19x88)	Lattialista 8kpl 19x35	Gable board 6pcs 19x90	Vindbräde 6st 19x90	Vindlist 4st 30x40	Roof felt fillet 2pcs 19x70	Eave board 5pcs 19x90	Eave board 10pcs 19x90	Eave board 8pcs 19x90	Eave board 8st 19x90
R1	R1	R2	F1	R3	FF	GB1	GB2	GS	RF1	EB1	EB2	EB3	EB4
Roofbräde för vindbräde 12st 19x70	Kaapelläuta yhdistämislauta 12kpl 19x70	Takförsbräde 2st 19x90	Fyllningsbräde 16x70x2060	Fyllningsbräde 16x80x2060	Täytriöläuta 16x80x2060	Corner board CB2	Corner board CB1	Kulmanlauta CB2	Corner board CB1	Corner board CB4	Corner board CB4	Corner board CB4	Corner board CB4
GCB	EB6	EB6	FIL1	FIL2	FIL3	CB2	CB1	CB2	CB1	CB4	CB4	CB4	CB4
Roofboard 21pcs (19x114) or 27pcs (19x88)	Takbräde 21st (19x114) och 27st (19x88)	Kattförläuta 21kpl (19x114) tai 27kpl (19x88)	Floorboard 34pcs (19x114) or 43pcs (19x88)	Golvbräde 34st (19x114) och 43st (19x88)	Lattialista 8kpl 19x35	Gable board 6pcs 19x90	Vindbräde 6st 19x90	Vindlist 4st 30x40	Roof felt fillet 4pcs 19x70	Eave board 2pcs 19x90	Takförsbräde 10st 19x90	Räystäsläuta 10kpl 19x90	Takförsbräde 8st 19x90
R2	R2	R2	F2	F2	FF	GB2	GB2	GS	RF1	EB1	EB2	EB3	EB4
Roofboard 42pcs (19x114) or 54pcs (19x88)	Takbräde 42st (19x114) och 54st (19x88)	Kattförläuta 42kpl (19x114) tai 54kpl (19x88)	Floorboard 34pcs (19x114) or 43pcs (19x88)	Golvbräde 34st (19x114) och 43st (19x88)	Lattialista 8kpl 19x35	Gable board 6pcs 19x90	Vindbräde 6st 19x90	Vindlist 4st 30x40	Roof felt fillet 4pcs 19x70	Eave board 2pcs 19x90	Takförsbräde 10st 19x90	Räystäsläuta 10kpl 19x90	Takförsbräde 8st 19x90
R3	R3	R3	F1	F2	FF	GB1	GB2	GS	RF1	EB1	EB2	EB3	EB4
Roofboard 21pcs (19x114) or 27pcs (19x88)	Takbräde 21st (19x114) och 27st (19x88)	Kattförläuta 21kpl (19x114) tai 27kpl (19x88)	Floorboard 34pcs (19x114) or 43pcs (19x88)	Golvbräde 34st (19x114) och 43st (19x88)	Lattialista 8kpl 19x35	Gable board 6pcs 19x90	Vindbräde 6st 19x90	Vindlist 4st 30x40	Roof felt fillet 4pcs 19x70	Eave board 2pcs 19x90	Takförsbräde 10st 19x90	Räystäsläuta 10kpl 19x90	Takförsbräde 8st 19x90
R2	R2	R2	F2	F2	FF	GB2	GB2	GS	RF1	EB1	EB2	EB3	EB4
Roofboard 42pcs (19x114) or 54pcs (19x88)	Takbräde 42st (19x114) och 54st (19x88)	Kattförläuta 42kpl (19x114) tai 54kpl (19x88)	Floorboard 34pcs (19x114) or 43pcs (19x88)	Golvbräde 34st (19x114) och 43st (19x88)	Lattialista 8kpl 19x35	Gable board 6pcs 19x90	Vindbräde 6st 19x90	Vindlist 4st 30x40	Roof felt fillet 4pcs 19x70	Eave board 2pcs 19x90	Takförsbräde 10st 19x90	Räystäsläuta 10kpl 19x90	Takförsbräde 8st 19x90
R3	R3	R3	F1	F2	FF	GB1	GB2	GS	RF1	EB1	EB2	EB3	EB4

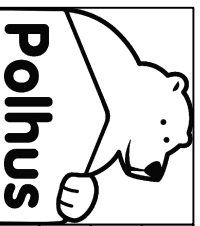

House	P3939-16 Sylvia	Sheet	2
Drawing		Scale	1:35
Material		Date	21.04.2014
Drawer		File	P3939-16 Sylvia.dwg

Date rev. Description

# Installation of floorbeams and floorboards - montering av golvbjälkar samt golvräddor - lattipalkien ja lattialautojen asennus

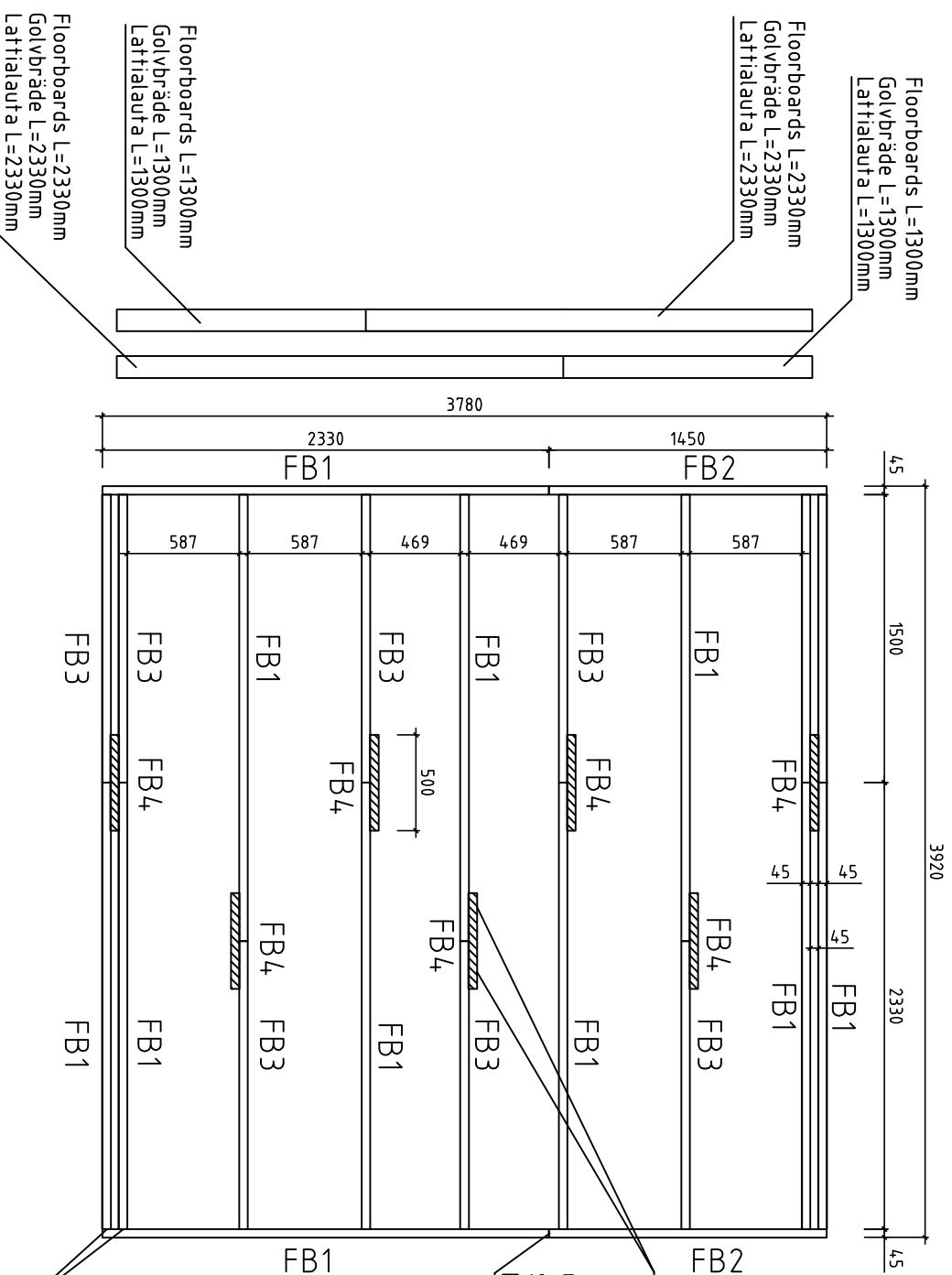

Floorboards L=1300mm  
Golvräde L=1300mm  
Lattialauta L=1300mm

Floorboards L=2330mm  
Golvräde L=2330mm  
Lattialauta L=2330mm

Floorboards L=1300mm  
Golvräde L=1300mm  
Lattialauta L=1300mm

Floorboards L=2330mm  
Golvräde L=2330mm  
Lattialauta L=2330mm

Connect with screws 4.5x70  
Skrivas samman med skruvar 4.5x70  
Kiinnitetään ruuveilla 4.5x70

Connect with metal plate 60x160+screws 4.5x4.5 8pcs  
Skarvas med metall platta 60x160+skruvar 4.5x4.5 8st  
Liitetään metallilevyllä 60x160+ruuvit 4.5x4.5 8kpl

Connect with screws 4.5x70  
Skrivas samman med skruvar 4.5x70  
Kiinnitetään ruuveilla 4.5x70

Date rev. Description

- NB!!! Change the floorboard positions after every row
- NB!!! Skarva golvräddorna olika efter varje rad
- NB!!! Muuta lattialautojen sijaintia jokaisen rivin jälkeen

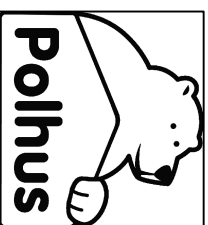

House	P3939-16 Sylvia	Sheet	3
Drawing	Floorbeams-lattipalkit-golvbjälkar	Scale	1:35
Material	4.5x90	Date	11.11.2014
Drawer	File	P3939-16 Sylvia.dwg	

Installation of wall element EL-1 - montering av vägg element EL-1 - seinäelementin EL-1 asennus  
(Front wall - vägg framsida - etuseinä)

View from inside - Från insidan - Näkymä sisältä

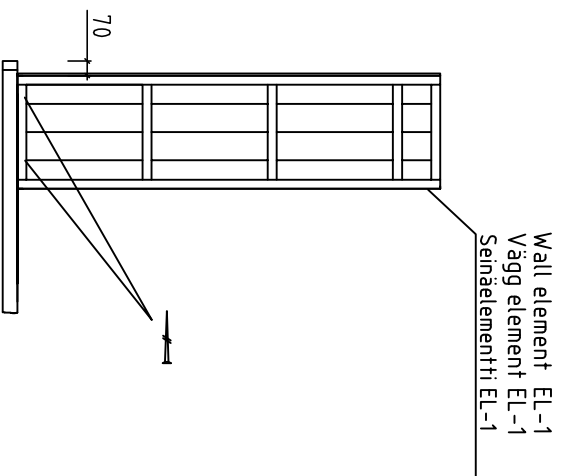

- Fix wall element EL-1 with screws
- 4.5x70 into floorbeam
- Fixera vägg element EL-1 med skruvar
- 4.5x70 i golvbjälke
- Kiinnitä seinäelementti EL-1 ruuveilla
- 4.5x70 lattiapalkkin

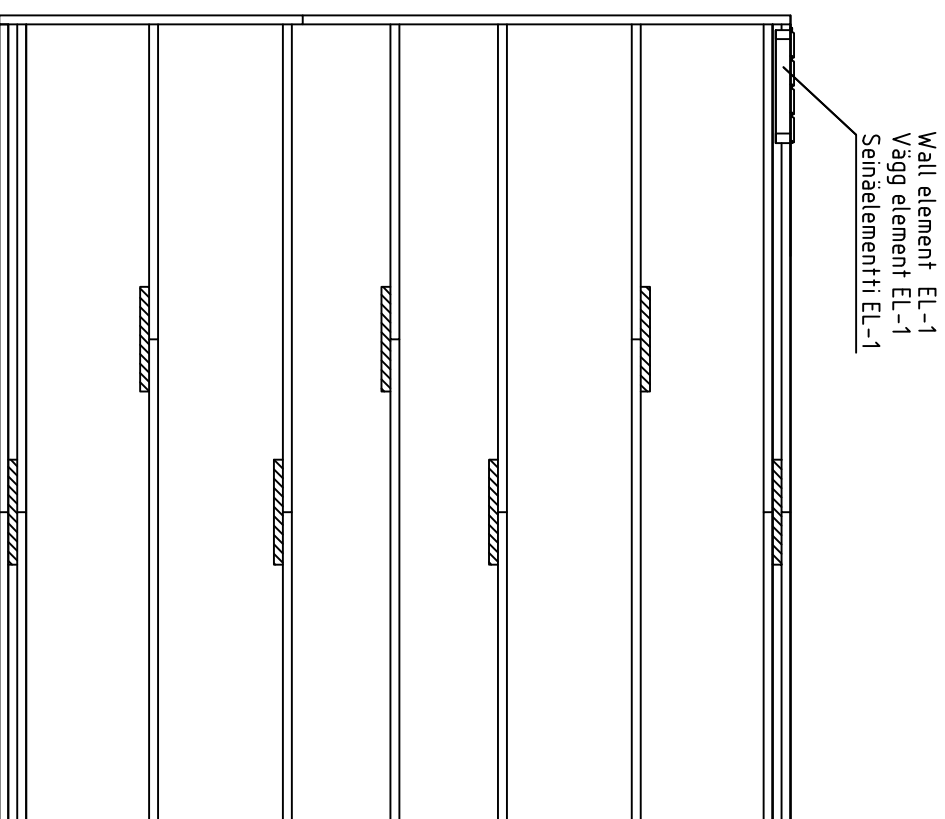

Date rev. Description

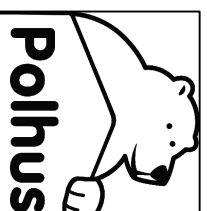

House	P3939-16 Sylvia	Sheet	4
Drawing		Scale	1:35
Material		Date	21.04.2014
Drawer		File	P3939-16 Sylviadwg



# Installation of wall element EL-2 and EL-1 - montering av vägg element EL-2 och EL-1 -seinäelementin EL-2 ja EL-1 asennus (Front wall - vägg framsida - etuseinä)

View from inside - Från insidan - Näkymä sisältä

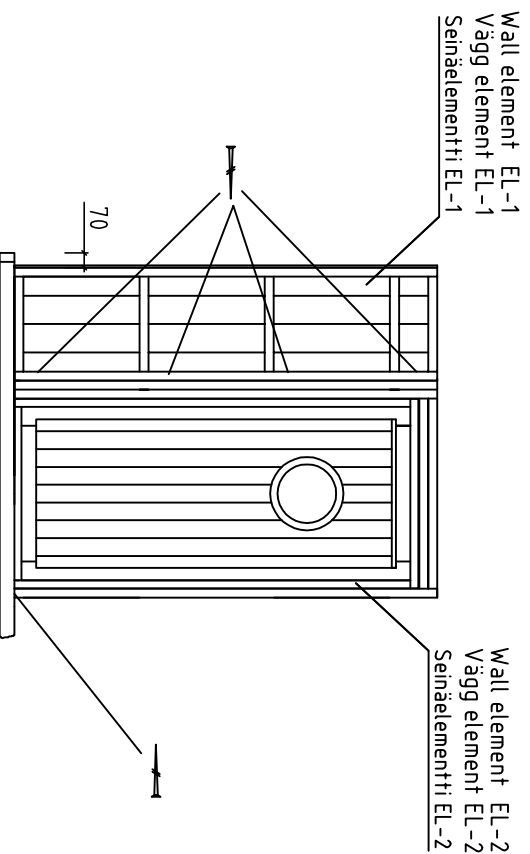

Fix wall element EL-2 with screws

4.5x70 into floorbeam

Fixera vägg element EL-2 med skruvar

4.5x70 i golvbjälke

Kiinnitä seinäelementti EL-2 ruuveilla

4.5x70 lattiapalkkin

Fix wall elements EL-2 and EL-1 with screws

4.5x70 together

Fixera vägg element EL-2 och EL-1 med skruvar

4.5x70 tillsammans

Kiinnitä seinäelementit EL-2 ja EL-1

yhteen ruuveilla 4.5x70

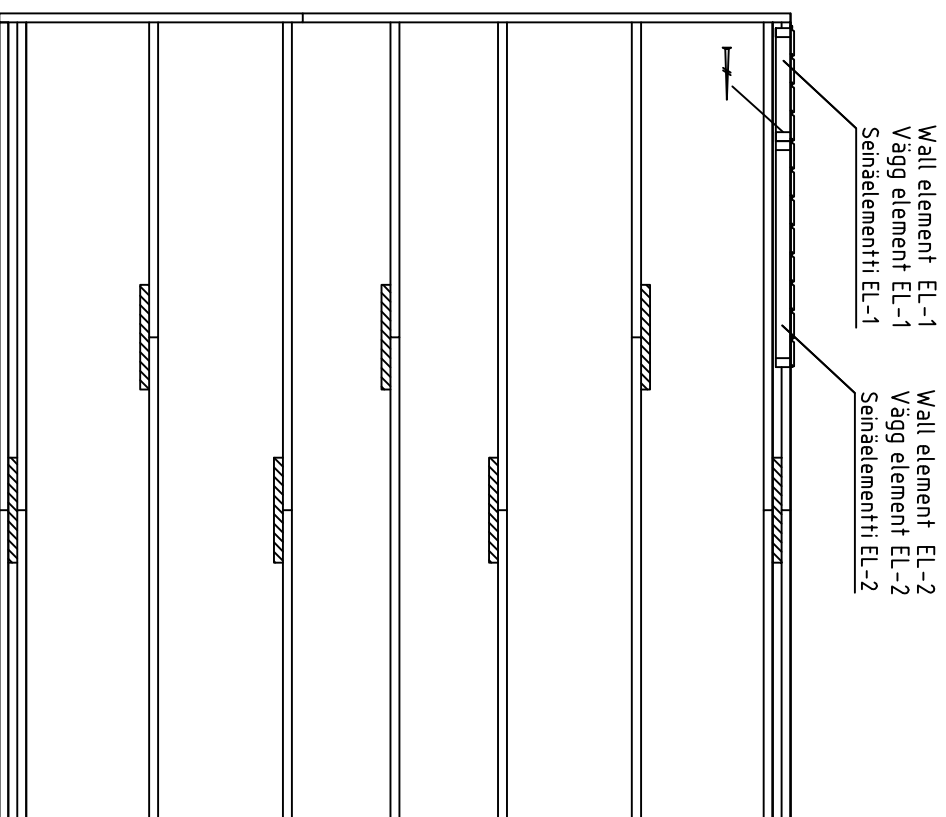

Date rev. Description

	House	P3939-16 Sylvia	Sheet	5
	Drawing		Scale	1:35
Material		Date	21.04.2014	
Drawer		File	P3939-16 Sylviadwg	

# Installation of wall element EL-1 and EL-2 - montering av vägg element EL-1 och EL-2 -seinälementin EL-1 ja EL-2 asennus

## (Front wall - vägg framsida - etuseinä)

View from inside - Från insidan - Näkymä sisältä

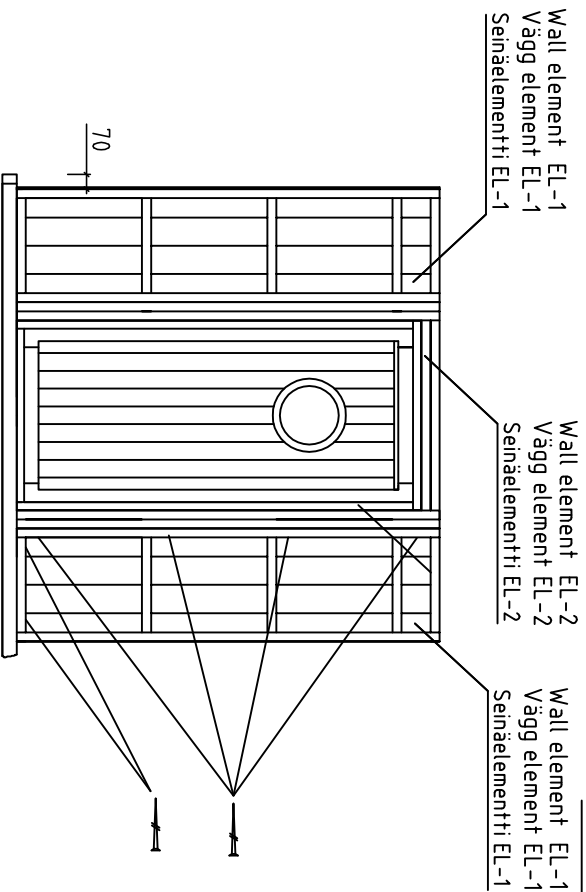

Wall element EL-1  
Vägg element EL-1  
Seinäelementti EL-1

Wall element EL-2  
Vägg element EL-2  
Seinäelementti EL-2

Wall element EL-1  
Vägg element EL-1  
Seinäelementti EL-1

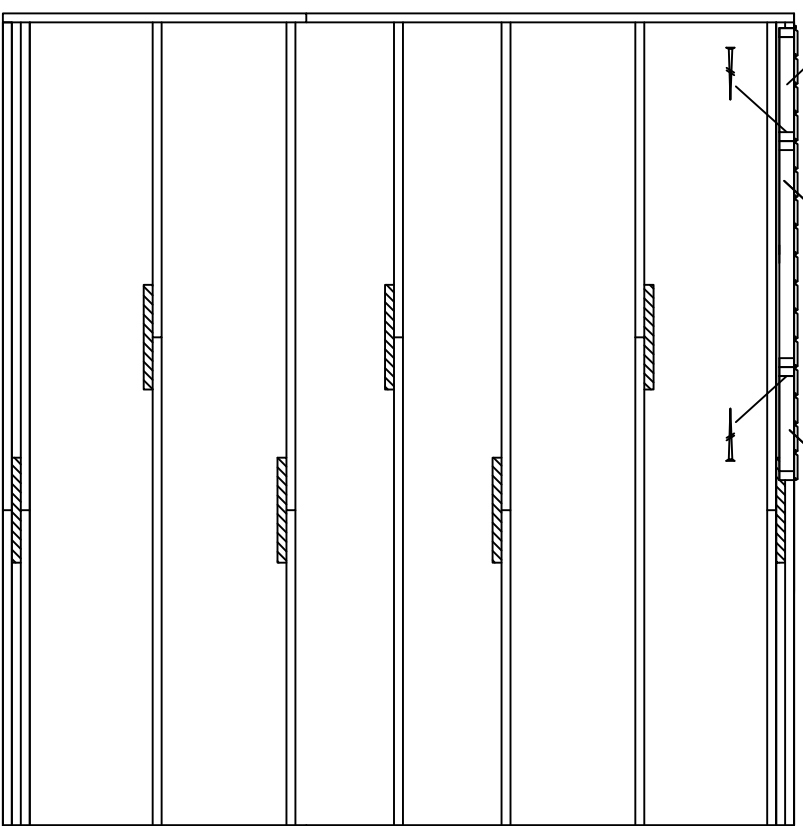

Fix wall element EL-1 with screws

4.5x70 into floorbeam

Fixera vägg element EL-1 med skruvar

4.5x70 i golvbjälke

Kiinnitä seinäelementti EL-1 ruuveilla

4.5x70 lattiapalkkin

Fix wall elements EL-1 and EL-2 with screws

4.5x70 together

Fixera vägg element EL-1 och EL-2 med skruvar

4.5x70 tillsammans

Kiinnitä seinäelementit EL-1 ja EL-2

yhteen ruuveilla 4.5x70

Date rev. Description

	House	P3939-16 Sylvia	Sheet	6
	Drawing		Scale	1:35
Material		Date	21.04.2014	
Drawer		File	P3939-16 Sylviadwg	

Installation of wall element EL-3 and EL-1 - montering av vägg element EL-3 och EL-1 -seinälementin EL-3 ja EL-1 asennus  
(Front wall - vägg framsida - etuseinä)

View from inside - Från insidan - Näkymä sisältä

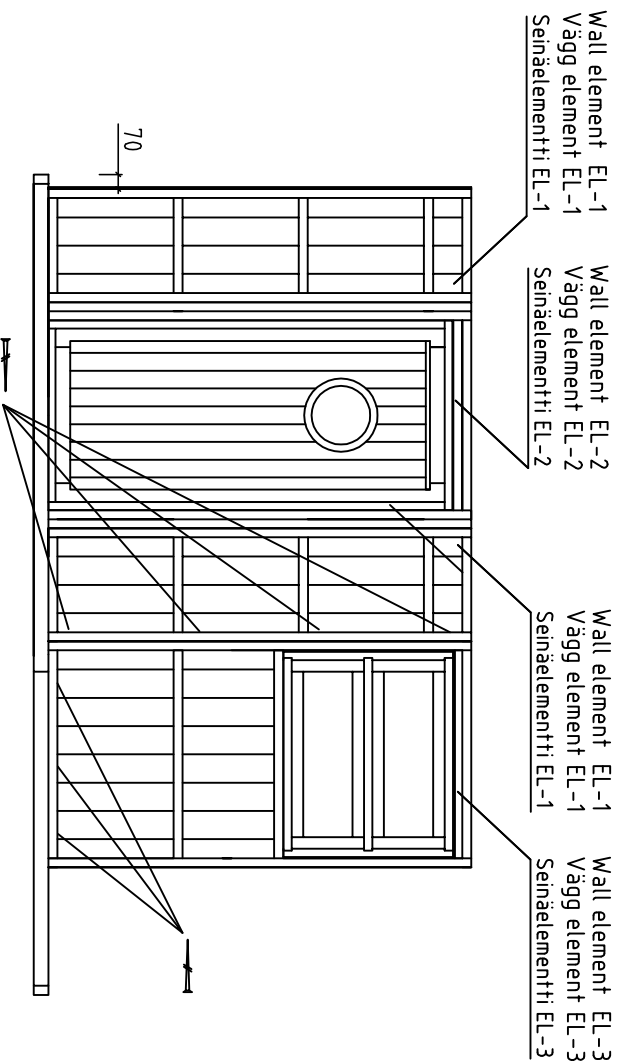

Wall element EL-1  
Vägg element EL-1  
Seinäelementti EL-1

Wall element EL-2  
Vägg element EL-2  
Seinäelementti EL-2

Wall element EL-1  
Vägg element EL-1  
Seinäelementti EL-1

Wall element EL-3  
Vägg element EL-3  
Seinäelementti EL-3

Fix wall element EL-3 with screws

4.5x70 into floorbeam

Fixera vägg element EL-3 med skruvar

4.5x70 i golvbjälke

Kiinnitä seinäelementti EL-3 ruuveilla

4.5x70 lattiapalkkin

Fix wall elements EL-3 and EL-1 with screws

4.5x70 together

Fixera vägg element EL-3 och EL-1 med skruvar

4.5x70 tillsammans

Kiinnitä seinäelementit EL-3 ja EL-1

yhteen ruuveilla 4.5x70

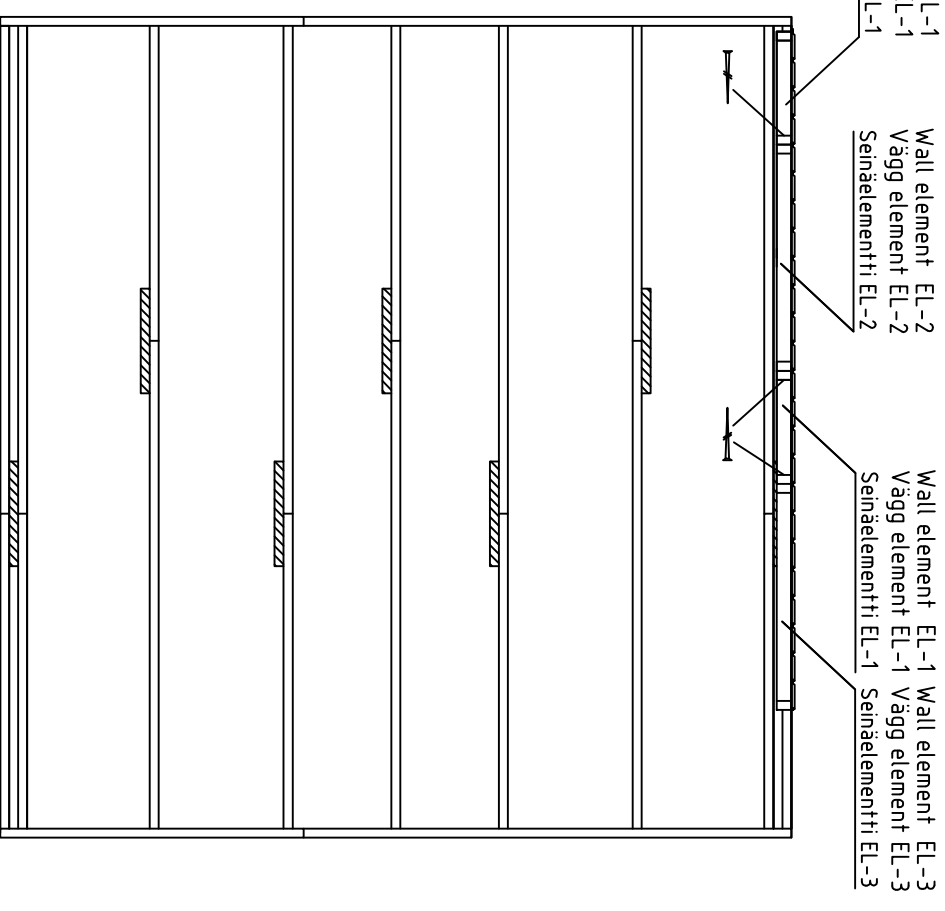

Date rev. Description

	House	P3939-16 Sylvia	Sheet	7
	Drawing		Scale	1:35
Material		Date	21.04.2014	
Drawer		File	P3939-16 Sylviadwg	

# Installation of wall element EL-3 and EL-1 – montering av vägg element EL-3 och EL-1 –seinälementin EL-3 ja EL-1 asennus (Front wall – vägg framsida – etuseinä)

View from inside – Från insidan – Näkymä sisältä

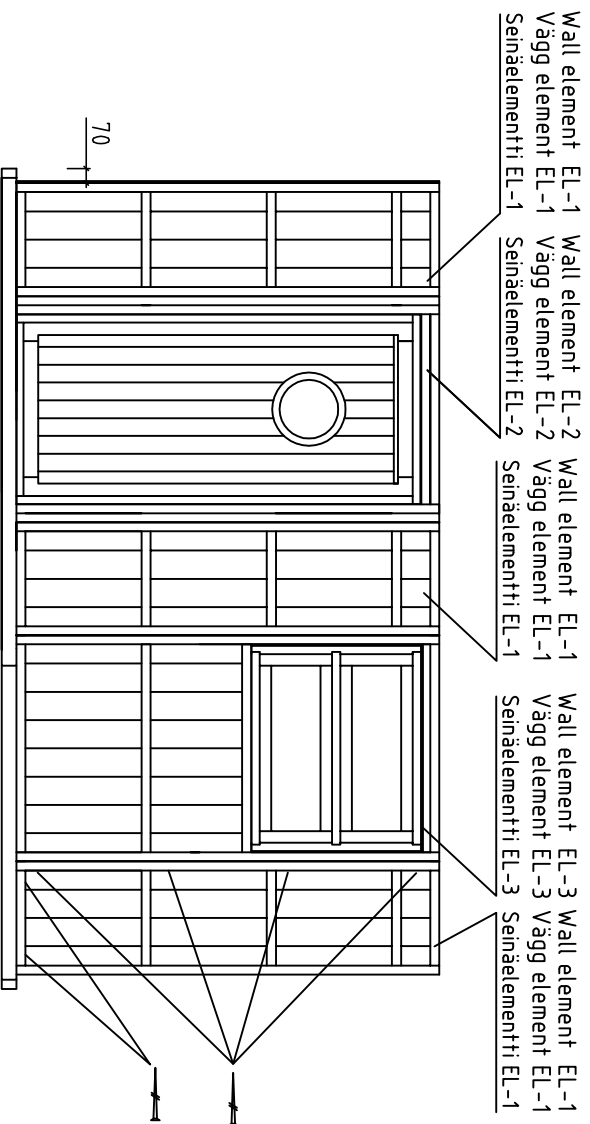

Wall element EL-1 Wall element EL-2 Wall element EL-1 Wall element EL-3 Wall element EL-1  
Vägg element EL-1 Vägg element EL-2 Vägg element EL-1 Vägg element EL-3 Vägg element EL-1  
Seinäelementti EL-1 Seinäelementti EL-2 Seinäelementti EL-1 Seinäelementti EL-3 Seinäelementti EL-1

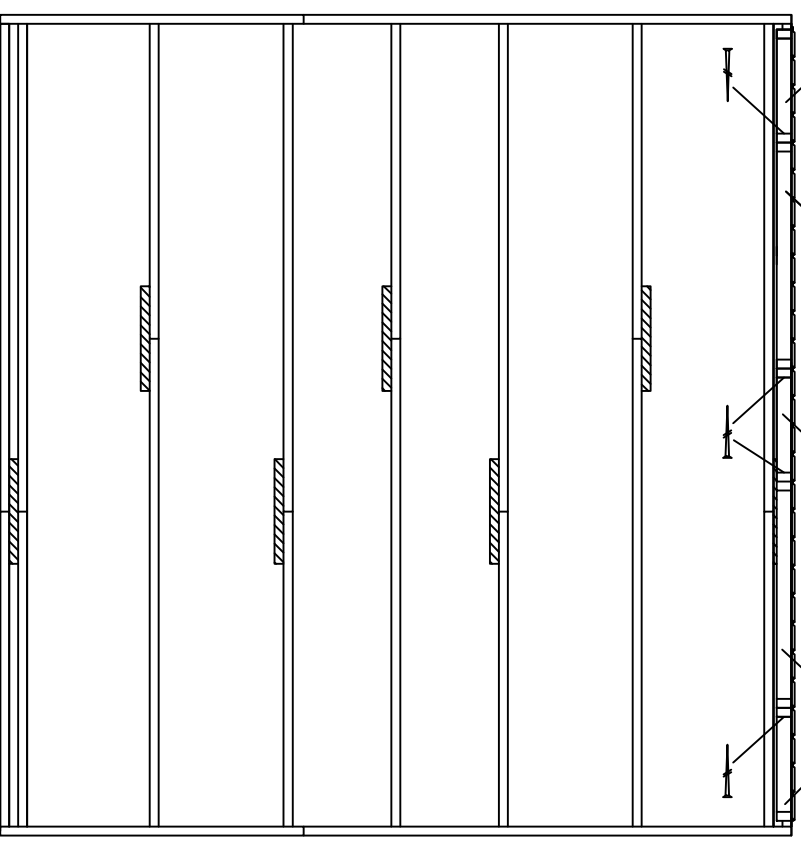

Fix wall element EL-1 with screws

4.5x70 into floorbeam

Fixera vägg element EL-1 med skruvar

4.5x70 i golvbjälke

Kiinnitä seinäelementti EL-1 ruuveilla

4.5x70 laattapalkkin

Fix wall elements EL-1 and EL-3 with screws

4.5x70 together

Fixera vägg element EL-1 och EL-3 med skruvar

4.5x70 tillsammans

Kiinnitä seinäelementit EL-1 ja EL-3

yhteen ruuveilla 4.5x70

Date rev. Description

House	P3939-16 Sylvia	Sheet	8
Drawing		Scale	1:35
Material		Date	21.04.2014
Drawer		File	P3939-16 Sylviadwg

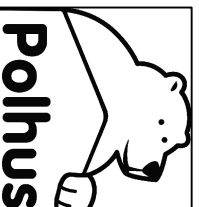

# Installation of left sidewall – montering av vänster sidovägg – vasen sivuseinä asennus

View from inside – Från insidan – Näkymä sisältä

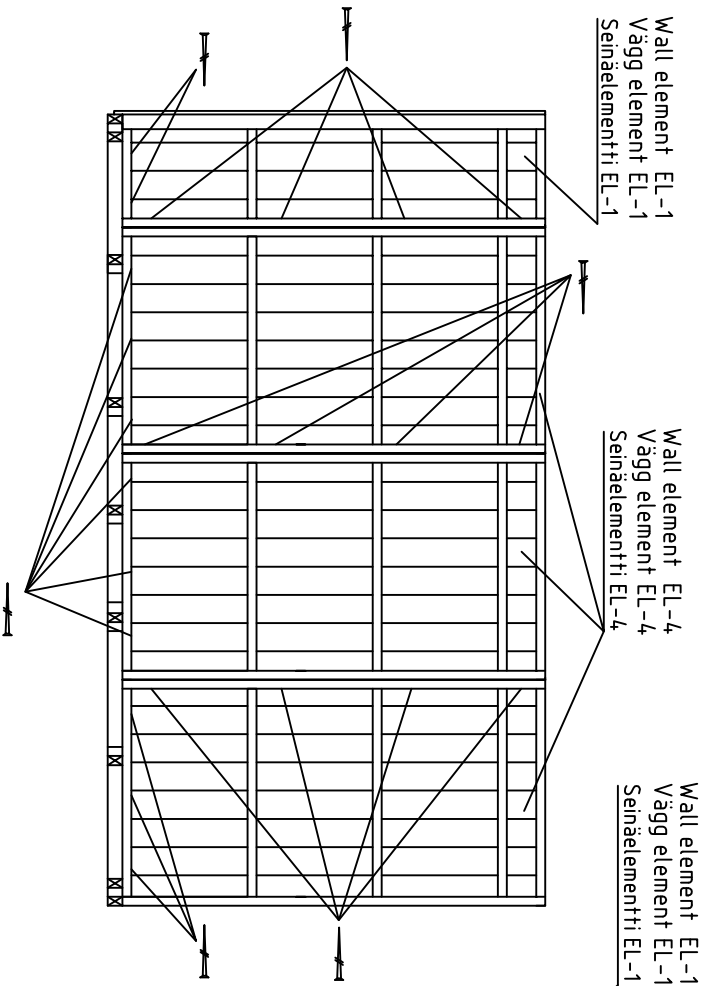

Fix wall element EL-1 and EL-4 (3pcs) with screws

4.5x70 into floorbeam

Fixera vägg element EL-1 och EL-4 (3st) med skruvar

4.5x70 i golvbjälke

Kiinnitä seinäelementti EL-1 ja EL-4 (3kpl) ruuveilla

4.5x70 lattiapalkkin

Fix wall elements EL-1 and EL-4 with screws 4.5x70 together

Fixera vägg element EL-1 och EL-4 med skruvar 4.5x70 tillsammans

Kiinnitä seinäelementit EL-1 ja EL-4 yhteen ruuveilla 4.5x70

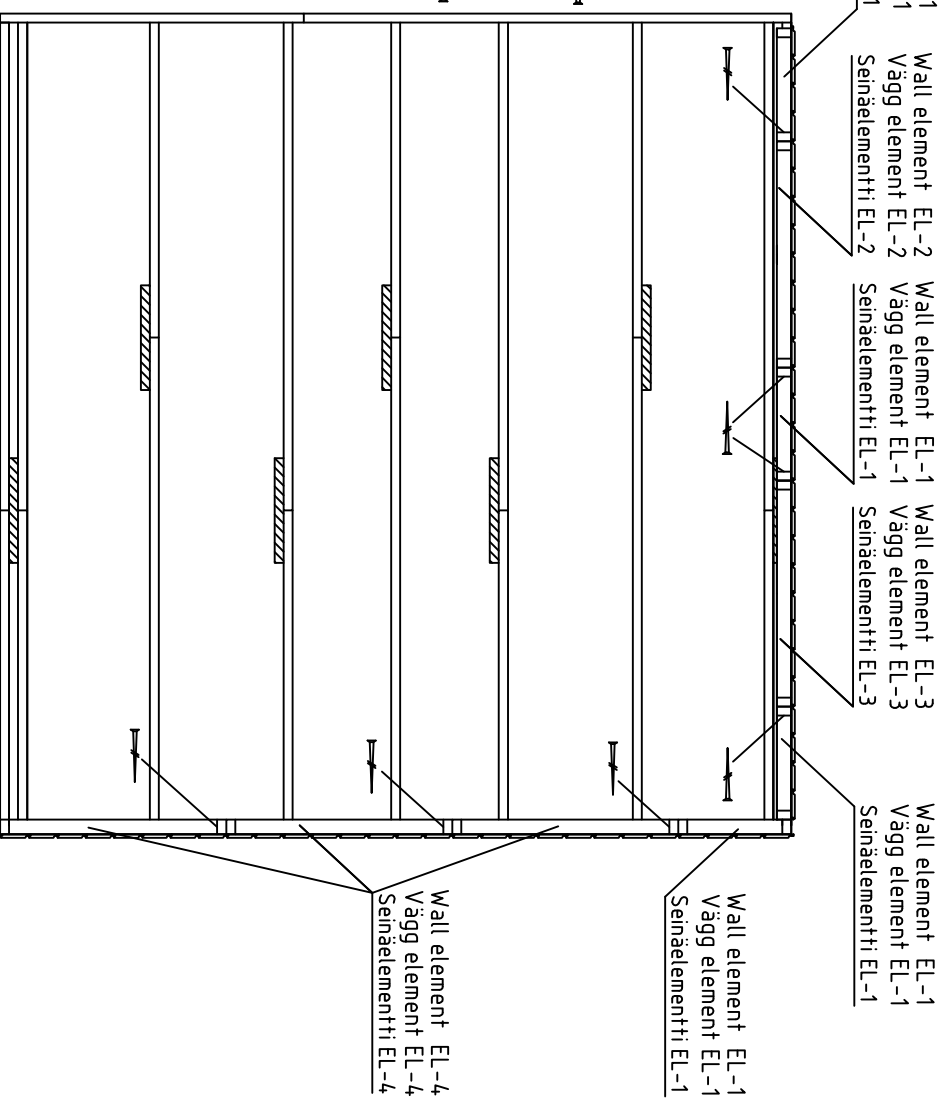

Date rev. Description

House	P3939-16 Sylvia	Sheet	9
Drawing		Scale	1:35
Material		Date	21.04.2014
Drawer		File	P3939-16 Sylviadwg

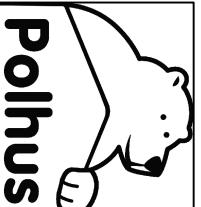

## Installation of back wall - montering av vägg baksida - takaseinä asennus

View from inside - Från insidan - Näkymä sisästä

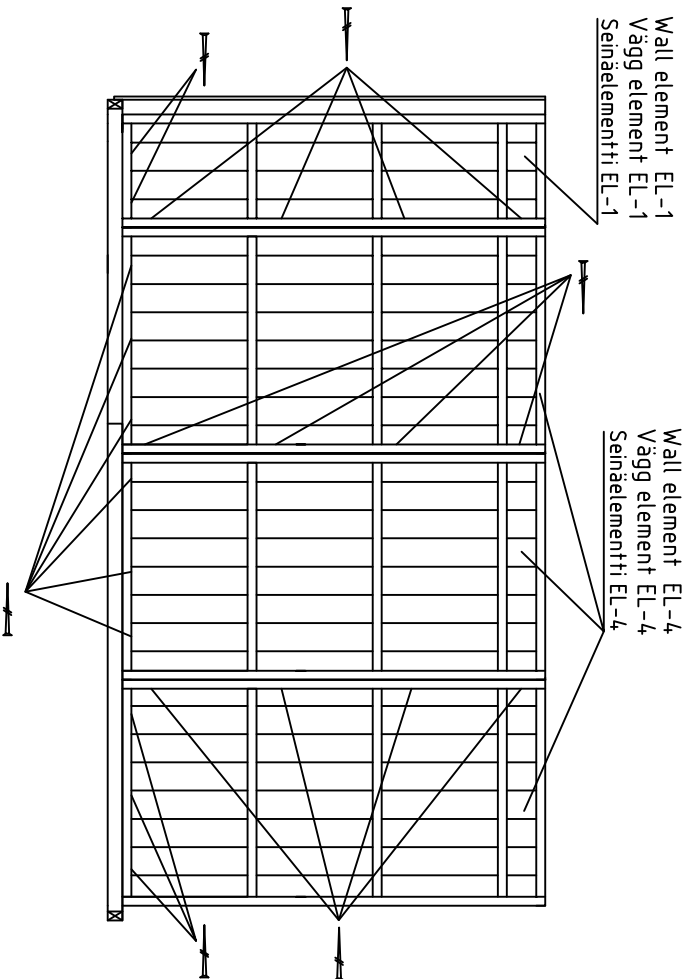

Fix wall element EL-1 and EL-4 (3pcs) with screws

4.5x70 into floorbeam

Fixera vägg element EL-1 och EL-4 (3st) med skruvar

4.5x70 i golvbjälke

Kiinnitä seinäelementti EL-1 ja EL-4 (3kpl) ruuveilla

4.5x70 lattiapalkkin

Fix wall elements EL-1 and EL-4 with screws 4.5x70 together

Fixera vägg element EL-1 och EL-4 med skruvar 4.5x70 tillsammans

Kiinnitä seinäelementit EL-1 ja EL-4 yhteen ruuveilla 4.5x70

Wall element EL-1  
Vägg element EL-1  
Seinäelementti EL-1

Wall element EL-2  
Vägg element EL-2  
Seinäelementti EL-2

Wall element EL-1  
Vägg element EL-1  
Seinäelementti EL-1

Wall element EL-3  
Vägg element EL-3  
Seinäelementti EL-3

Wall element EL-1  
Vägg element EL-1  
Seinäelementti EL-1

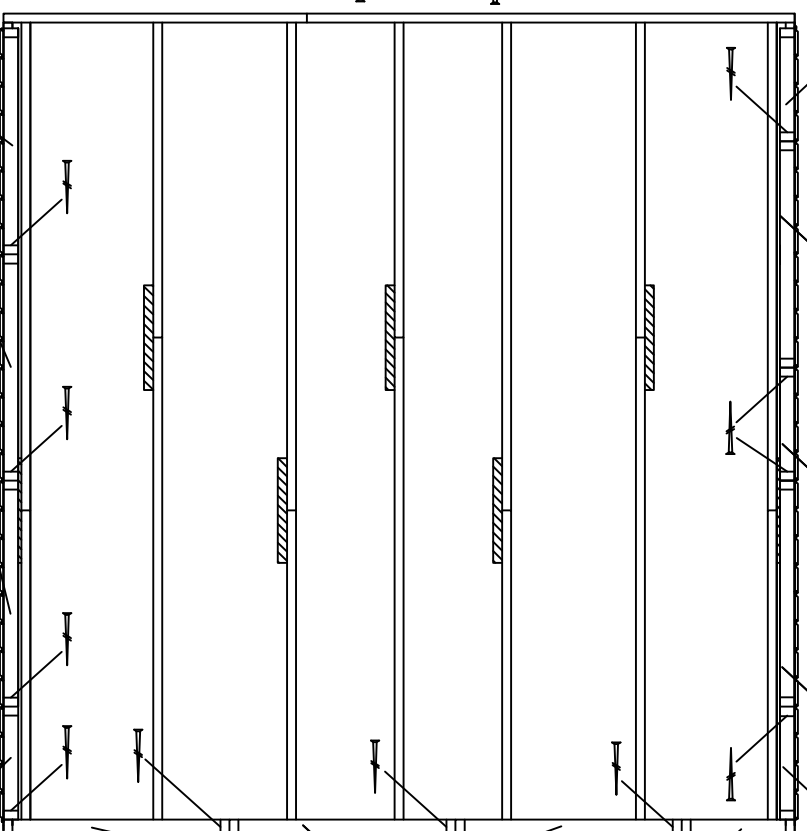

Wall element EL-4  
Vägg element EL-4  
Seinäelementti EL-4

Wall element EL-2  
Vägg element EL-2  
Seinäelementti EL-2

Wall element EL-4  
Vägg element EL-4  
Seinäelementti EL-4

Date rev. Description

Wall element EL-1  
Vägg element EL-1  
Seinäelementti EL-1

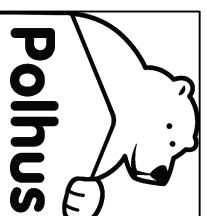

House	P3939-16 Sylvia	Sheet	10
Drawing		Scale	1:35
Material		Date	21.04.2014
Drawer		File	P3939-16 Sylviadwg

# Installation of right sidewall – montering av höger sidovägg – oikea sivuseinä asennus

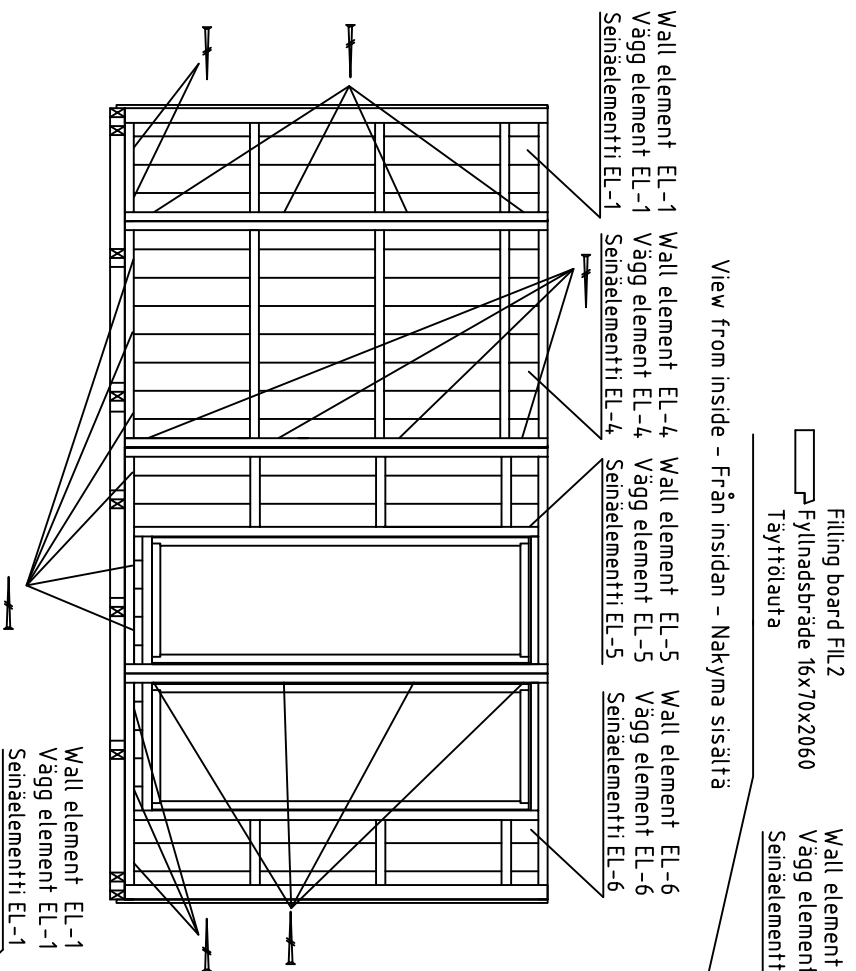

Wall element EL-1, EL-4, EL-5 and EL-6 with screws  
 4.5x70 into floorbeam  
 Fixera vägg element EL-1, EL-4, EL-5 och EL-6 med skruvar  
 4.5x70 i golvbjälke  
 Kiinnitä seinäelementti EL-1, EL-4, EL-5 ja EL-6 ruuveilla  
 4.5x70 lattiapalkkin

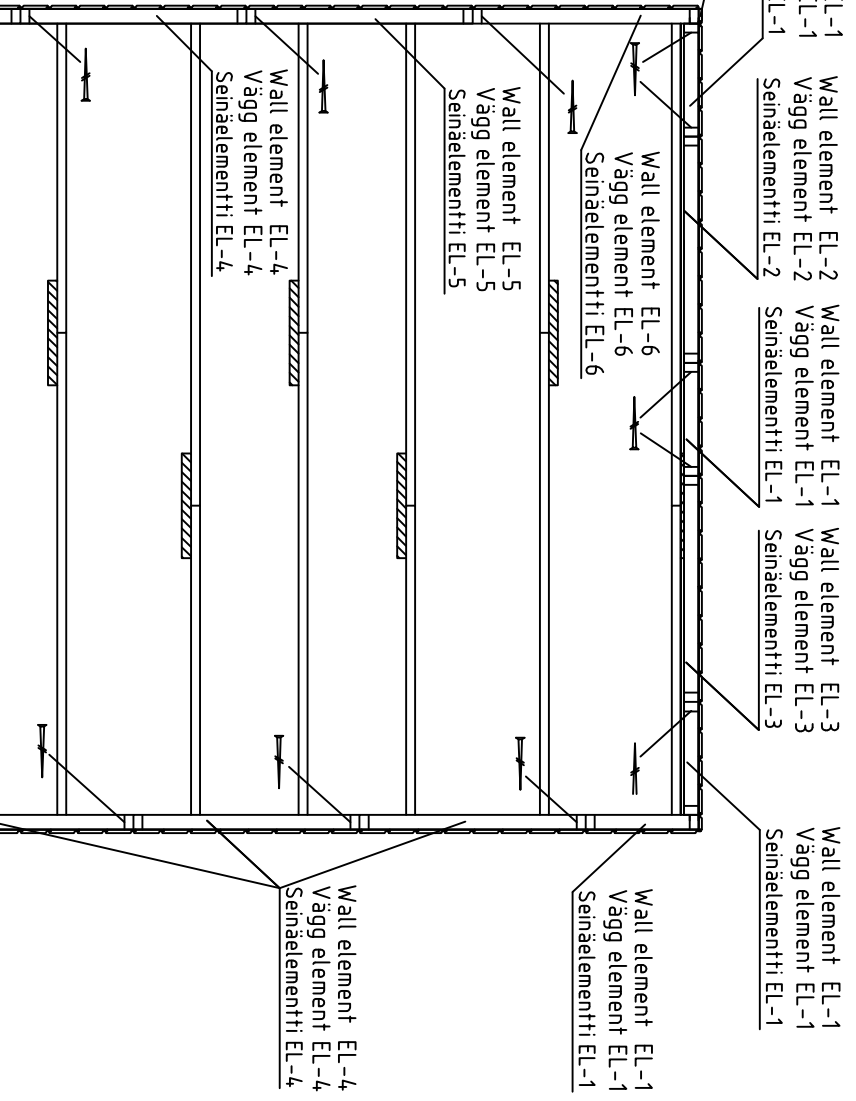

Wall element EL-1, EL-4, EL-5 and EL-6 with screws  
 4.5x70 into floorbeam  
 Fixera vägg element EL-1, EL-4, EL-5 och EL-6 med skruvar  
 4.5x70 tillsammans  
 Kiinnitä seinäelementti EL-1, EL-4, EL-5 ja EL-6 ruuveilla  
 4.5x70

Wall element EL-4  
 Vägg element EL-4  
 Seinäelementti EL-4

Wall element EL-1  
 Vägg element EL-1  
 Seinäelementti EL-1

Wall element EL-4  
 Vägg element EL-4  
 Seinäelementti EL-4

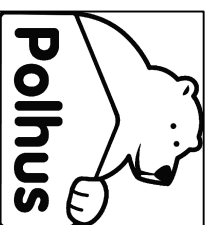

House	Sheet
P3939-16 Sylvia	11
Drawing	Scale
Material	1:35
Date	Date
21.04.2014	
rev.	Description
Drawer	File
	P3939-16 Sylviadwg

Installation of back wall connecting beams - montering av bjälkar för vägg baksida sammanslagning - takaseinän yhdistämispalkit asennus

Screws 4.5x70 4pcs  
 Skruvar 4.5x70 4st  
 Ruuvit 4.5x70 4kpl

Screws 4.5x70 4pcs  
 Skruvar 4.5x70 4st  
 Ruuvit 4.5x70 4kpl

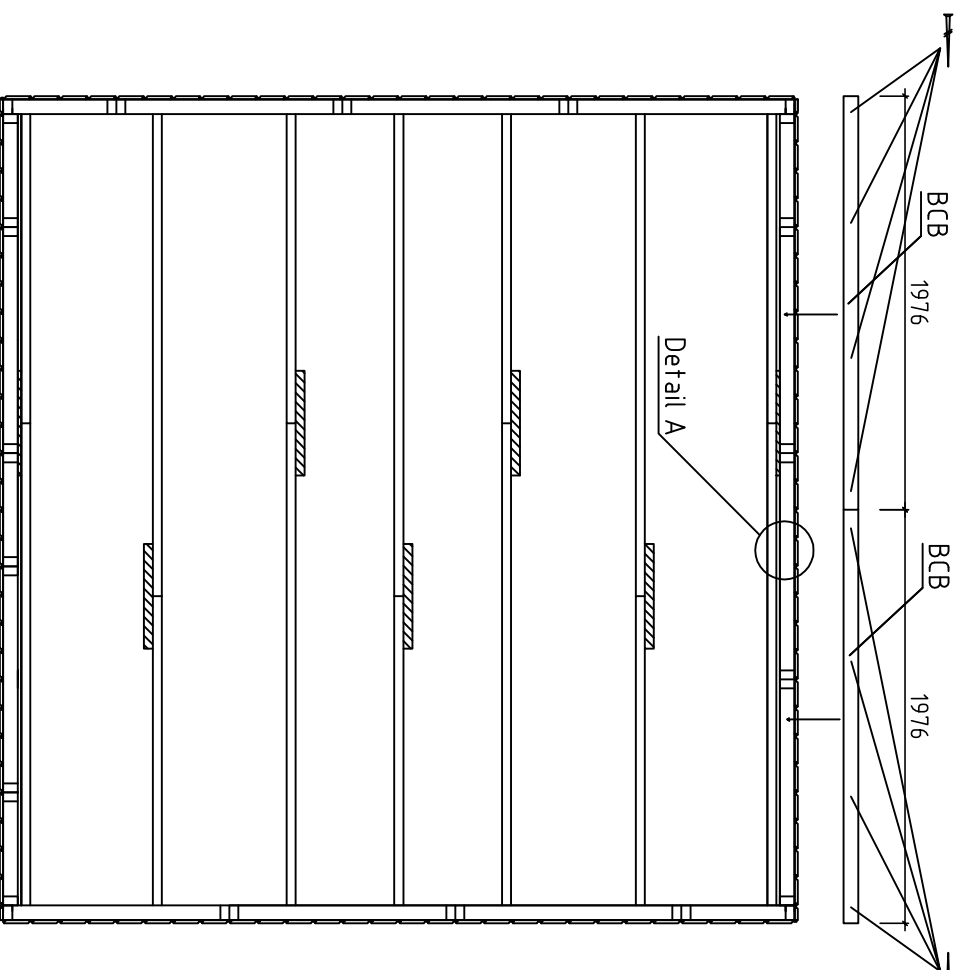

Screws 4.5x70  
 Skruvar 4.5x70  
 Ruuvit 4.5x70

Detail A

BCB

Back wall-vägg baksida-takaseinä

Date rev. Description

			
House	P3939-16 Sylvia	Sheet	12
Drawing		Scale	1:35
Material		Date	21.04.2014
Drawer		File	P3939-16 Sylviadwg



Installation of wall element EL-7 and EL-8 – monterering av vägg element EL-7 och EL-8 –seinäelementin EL-7 ja EL-8 asennus  
(Front wall – vägg framsida – etuseinä)

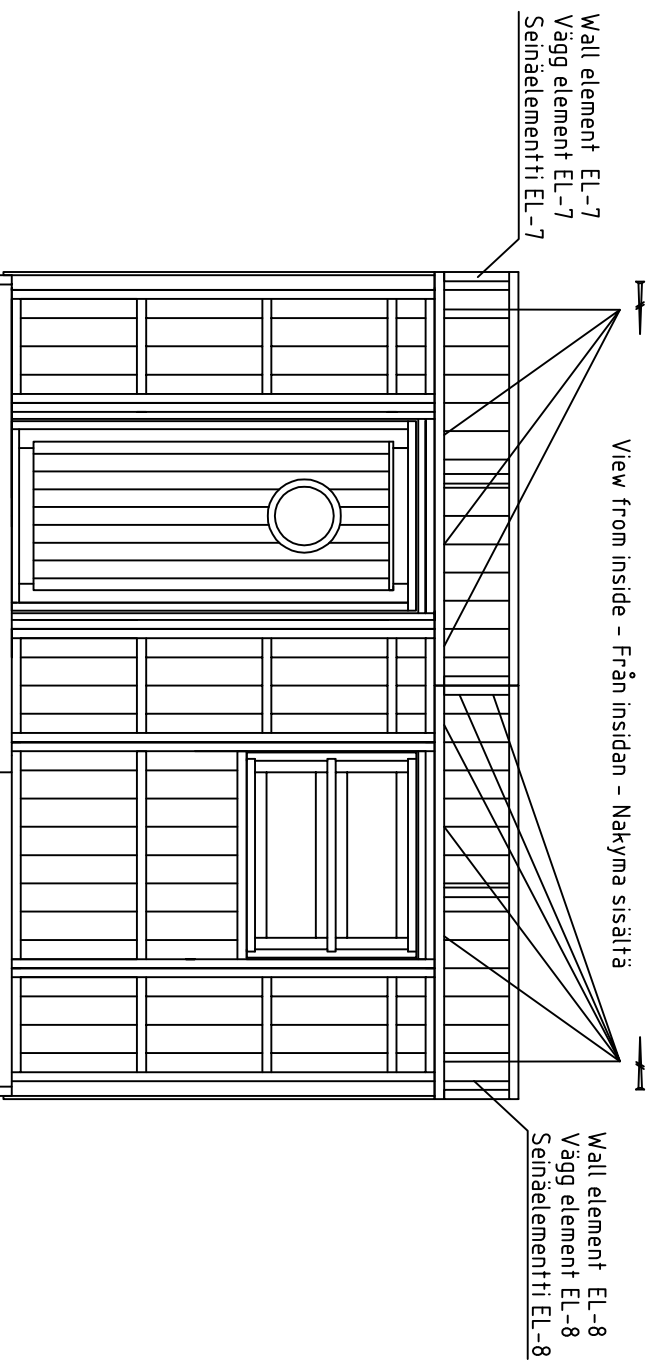

Fix wall element EL-7 with front wall elements with screws 4.5x70 together

Fixera vägg element EL-7 med elementat vägg framsida med skruvar 4.5x70 tillsammans

Kiinnitä seinäelementti EL-7 yhteen etuseinän elementit ruuveilla 4.5x70

Fix wall element EL-8 to front wall elements with screws 4.5x70 together

Fixera vägg element EL-8 med elementat vägg framsida med skruvar 4.5x70 tillsammans

Kiinnitä seinäelementti EL-8 yhteen etuseinä elementit ruuveilla 4.5x70

Fix wall elements EL-7 and EL-8 with screws 4.5x70 together

Fixera vägg element EL-7 och EL-8 med skruvar 4.5x70 tillsammans

Kiinnitä seinäelementit EL-7 ja EL-8 yhteen ruuveilla 4.5x70

Date rev. Description

House	P3939-16 Sylvia	Sheet	13
Drawing		Scale	1:35
Material		Date	21.04.2014
Drawer		File	P3939-16 Sylviadwg

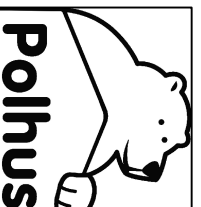

Installation of wall element EL-9 and EL-10 – montering av vägg element EL-9 och EL-10 – seinäelementin EL-9 ja EL-10 asennus  
(Left sidewall – vänster sidovägg – vasen sivuseinä)

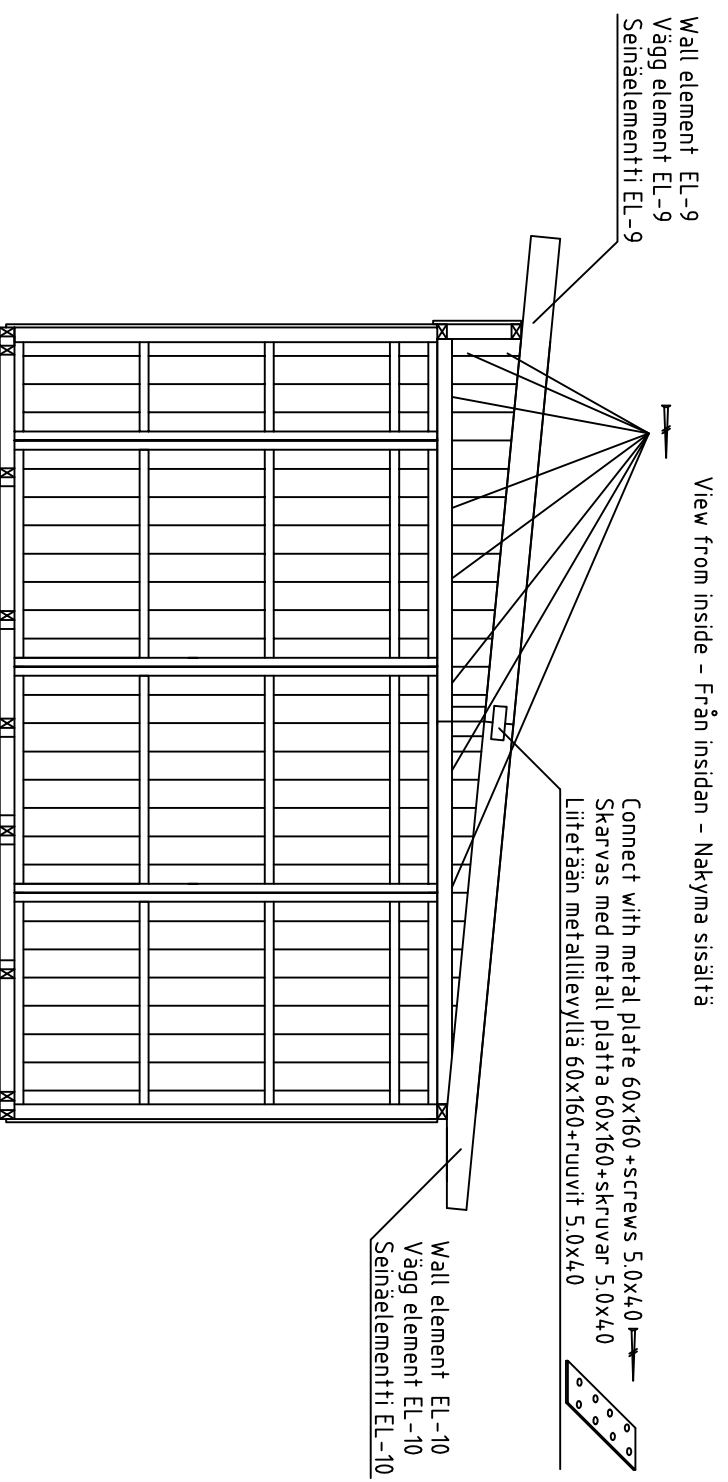

Fix wall element EL-9 with left sidewall elements with screws 5.0x120 together

Fixera vägg element EL-9 med elementat vänster sidovägg med skruvar 5.0x120 tillsammans

Kiinnitä seinäelementti EL-9 yhteen vasen sivuseinä elementit ruuveilla 5.0x120

Fix wall elements EL-9 and EL-8 with screws 5.0x120 together

Fixera vägg element EL-9 och EL-8 med skruvar 5.0x120 tillsammans

Kiinnitä seinäelementit EL-9 ja EL-8 yhteen ruuveilla 5.0x120

Fix wall element EL-10 with left sidewall elements with screws 5.0x120 together

Fixera vägg element EL-10 med elementat vänster sidovägg med skruvar 5.0x120 tillsammans

Kiinnitä seinäelementti EL-10 yhteen vasen sivuseinä elementit ruuveilla 5.0x120

Date rev. Description

House	P3939-16 Sylvia	Sheet	14
Drawing		Scale	1:35
Material		Date	21.04.2014
Drawer		File	P3939-16 Sylviadwg

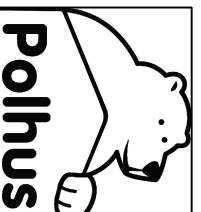

Installation of wall element EL-11 and EL-12 – montering av vägg element EL-11 och EL-12 – seinäelementin EL-11 ja EL-12 asennus

(Right sidewall – höger sidovägg – oikea sivuseinä)

View from inside – Från insidan – Näkymä sisältä

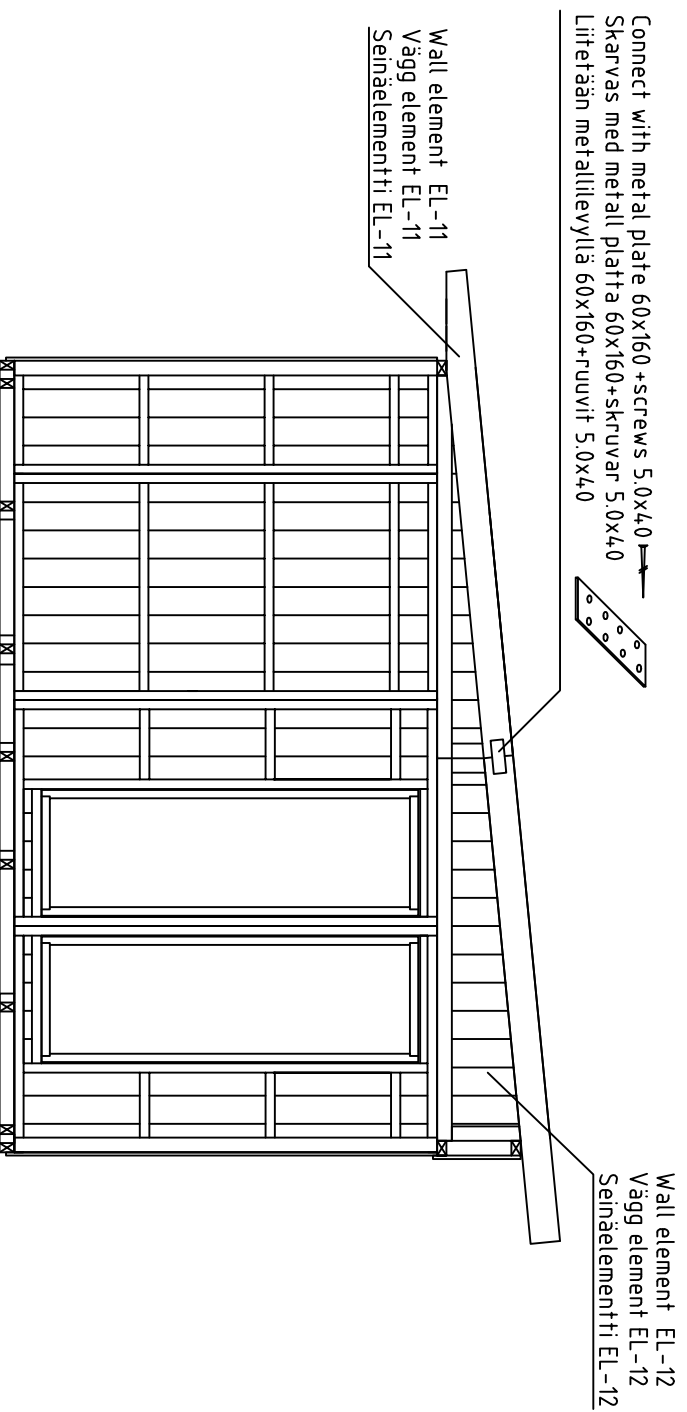

Fix wall element EL-11 with right sidewall elements with screws 5.0x120 together

Fixera vägg element EL-11 med elementat höger sidovägg med skruvar 5.0x120 tillsammans

Kiinnitä seinäelementti EL-11 yhteen oikea sivuseinä elementit ruuveilla 5.0x120

Fix wall element EL-12 with right sidewall elements with screws 5.0x120 together

Fixera vägg element EL-12 med elementat höger sidovägg med skruvar 5.0x120 tillsammans

Kiinnitä seinäelementti EL-12 yhteen oikea sivuseinä elementit ruuveilla 5.0x120

Fix wall elements EL-12 and EL-7 with screws 5.0x120 together

Fixera vägg element EL-12 och EL-7 med skruvar 5.0x120 tillsammans

Kiinnitä seinäelementit EL-12 ja EL-7 yhteen ruuveilla 5.0x120

Date      rev.      Description

House	P3939-16 Sylvia	Sheet	15
Drawing		Scale	1:35
Material		Date	21.04.2014
Drawer		File	P3939-16 Sylviadwg

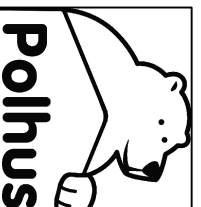

## Roofbeams connecting-montering av takbjälkar-kattopalkki yhdistamine

Connect with nails 5,0x120  
 Fixera med spikar 5,0x120 ←  
 Kiiniä yhteen naulalla 5,0x120

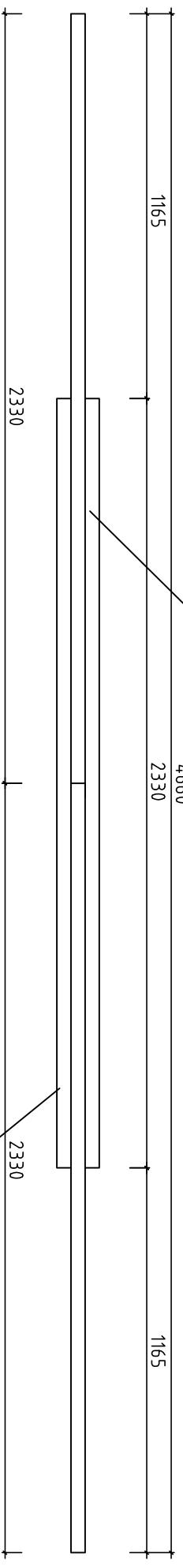

Connect with nails 5,0x120  
 Fixera med spikar 5,0x120 ←  
 Kiiniä yhteen naulalla 5,0x120

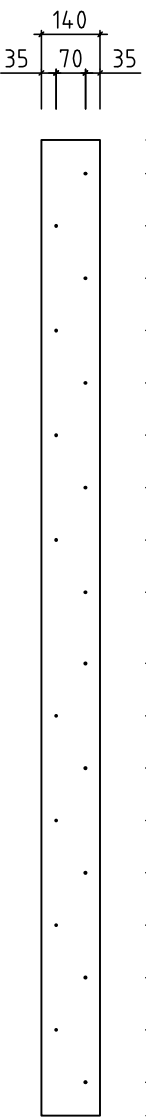
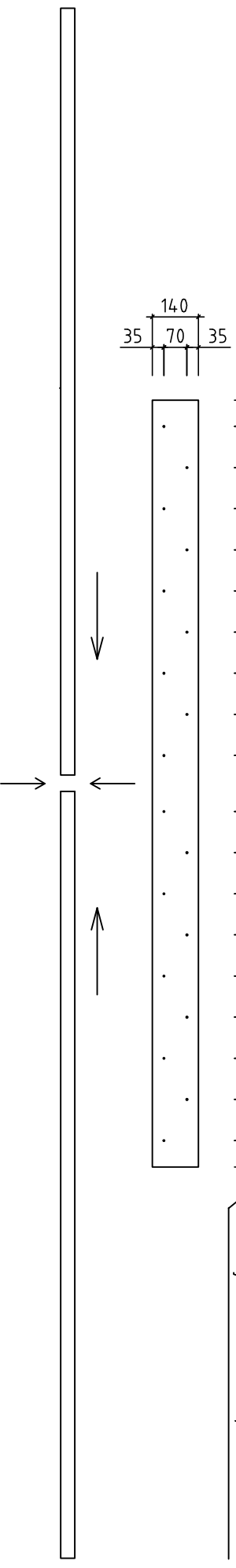

NB!!! Bore holes  $\varnothing$ 5mm before so that on one side and on other side holes dosen't match

NB!!! Skruva från båda sidorna men inte så att dessa möter varandra

Date rev. Description

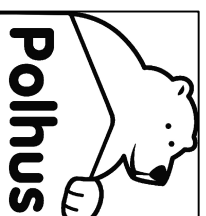

House	P3939-16 Sylvia	Sheet	16
Drawing	Roofbeams connecting-montering av takbjälkar	Scale	1:35
Material		Date	21.04.2014
Drawer		File	P3939-16 Sylviadwg

# Ferm install-installera takläggning-kattoparru asennus

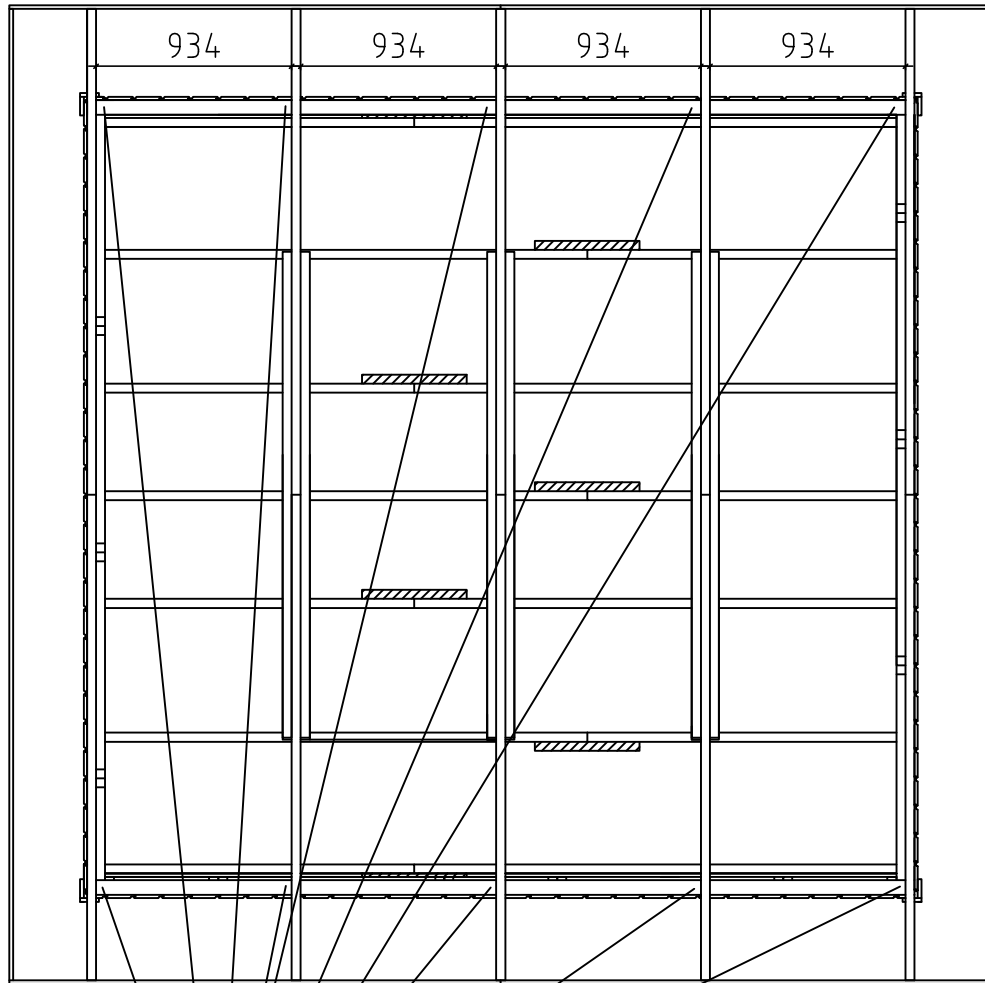
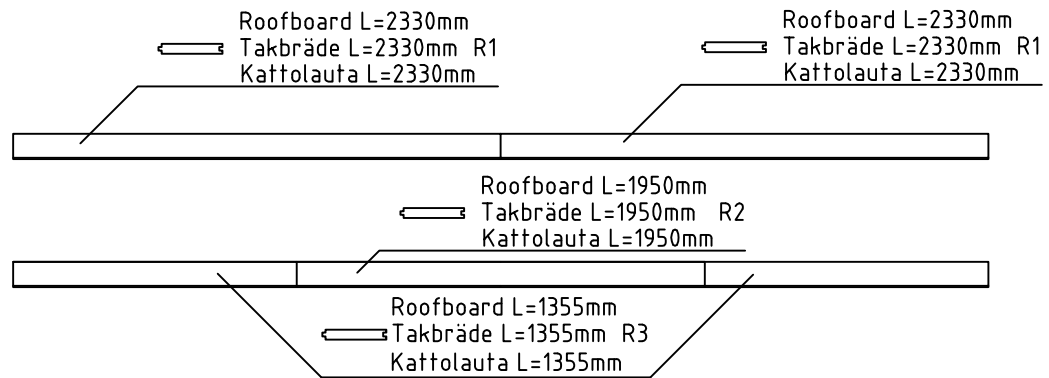

Connect with steel corner 90x90x65+screws 4.5x45 8pcs  
Skarvas med metallvinkel 90x90x65+skruvar 4.5x45 8st  
Liitetään kulmarautaan 90x90x65+ruuvit 4.5x45 8kpl



NB!!! Change the roofboard positions after every row  
NB!!! Skarva tak brädorna olika efter varje rad  
NB!!! Muuta kattolautojen sijaintia jokaisen rivin jälkeen

Date rev. Description

	House	P3939-16 Sylvia	Sheet	17
	Drawing		Scale	1:35
	Material		Date	21.04.2014
	Drawer		File	P3939-16 Sylvia.dwg

2 PAKKI L<2.35m

Pos

P3939-16 Sylvia

Nr. Profile L  
Pcs. (mm) (mm)

Wall element EL-7 1pc  
Vägg element EL-7 1st  
Seinäelementti EL-7 1kpl  
1976x420x86

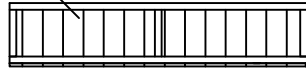

Wall element EL-8 1pc  
Vägg element EL-8 1st  
Seinäelementti EL-8 1kpl  
1986x420x86

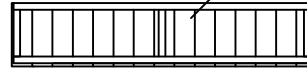

Wall element EL-1 6pcs  
Vägg element EL-1 6st  
Seinäelementti EL-1 6kpl  
550x2060x86

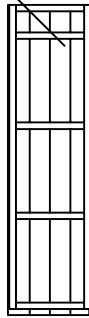

WS-1

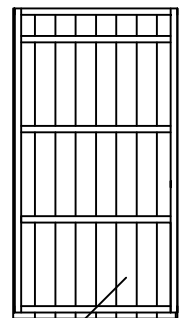
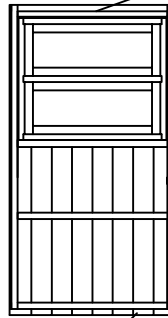
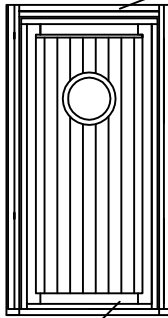

Wall element EL-2 1pc  
Vägg element EL-2 1st  
Seinäelementti EL-2 1kpl  
1090x2060x86

Wall element EL-3 1pc  
Vägg element EL-3 1st  
Seinäelementti EL-3 1kpl  
1090x2060x86

Wall element EL-4 7pcs  
Vägg element EL-4 7st  
Seinäelementti EL-4 7kpl  
1090x2060x86

Wall element EL-5 1pc  
Vägg element EL-5 1st  
Seinäelementti EL-5 1kpl  
1090x2060x86

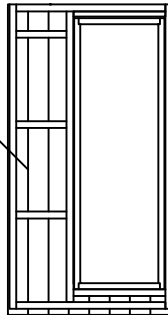

Wall element EL-6 1pc  
Vägg element EL-6 1st  
Seinäelementti EL-6 1kpl  
1090x2060x86



Wall element EL-9 1pc  
Vägg element EL-9 1st  
Seinäelementti EL-9 1kpl  
2337x607x59

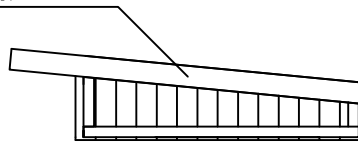

Wall element EL-10 1pc  
Vägg element EL-10 1st  
Seinäelementti EL-10 1kpl  
2333x384x59

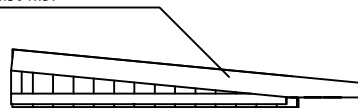

Wall element EL-11 1pc  
Vägg element EL-11 1st  
Seinäelementti EL-11 1kpl  
2333x384x59

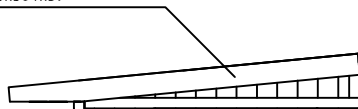

Wall element EL-12 1pc  
Vägg element EL-12 1st  
Seinäelementti EL-12 1kpl  
2333x607x59

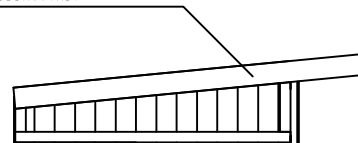

Polhus











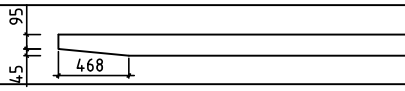
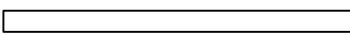
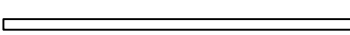
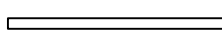
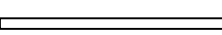

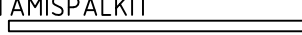







Kood P3939-16 Sylvia

Materiaal

File P3939-16 Sylvia.dwg

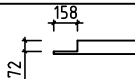













Leht 1/3

# 2 PAKKI L<2.35m

Pos	P3939-16 Sylvia	Nr. Pcs.	Profile (mm)	L (mm)
RA1	RAFTER - KATTOPALKI - TAKBJÄLKAR 	3	43x140	2330
RA2	RAFTER - KATTOPALKI - TAKBJÄLKAR 	9	43x140	2330
FB1	FLOORBEAM - LATTIAPALKI - GOLVBJÄLKAR 	11	45x90	2330
FB2	FLOORBEAM - LATTIAPALKI - GOLVBJÄLKAR 	2	45x90	1450
FB3	FLOORBEAM - LATTIAPALKI - GOLVBJÄLKAR 	9	45x90	1500
FB4	FLOORBEAM CONNECTING BEAM - LATTIAPALKI YHDISTAMISPALKIT BRÄDE FÖR GOLVBJÄLKAR SAMMANSLAGNING 	7	45x90	500
BCB	BACK WALL CONNECTING BEAM - TAKASEINÄ YHDISTAMISPALKIT BJÄLKAR FÖR SIDOVÄGG SAMMANSLAGNING 	2	45x70	1976
F1	FLOORBOARD - LATTIALAUTA - GOLVBRÄDE  88mm or-tai-eller 114mm	34 43	19x114 19x88	2330 2330
F2	FLOORBOARD - LATTIALAUTA - GOLVBRÄDE  88mm or-tai-eller 114mm	34 43	19x114 19x88	1300 1300
R1	ROOFBOARD - KATTOLAUTA - TAKBRÄDE  88mm or-tai-eller 114mm	42 54	19x114 19x88	2330 2330
R2	ROOFBOARD - KATTOLAUTA - TAKBRÄDE  88mm or-tai-eller 114mm	21 27	19x114 19x88	1950 1950
R3	ROOFBOARD - KATTOLAUTA - TAKBRÄDE  88mm or-tai-eller 114mm	42 54	19x114 19x88	1355 1355
FF	FLOOR FILLET - LATTIALISTA - GOLVLIST 	8	19x35	1900
GB1 GB2	GABLE BOARD - KAAPELILAUTA - GAVELBRÄDA 	6 4	19x90 19x90	2330 1165
GS	GABLE SLAT - KAAPELILISTA - VINDLIST 	4	30x40	2330
GCB	GABLE BOARD CONNECTING BOARD - KAAPELILAUTA YHDISTAMISLAUTA - BRÄDE FÖR FIXERA VINDBRÄDE 	12	19x70	130
RFF1 RFF2	ROOF FELT FILLET - KATON PÄÄTYLAUTA - BRÄDE OVANPÅ GAVELBRÄDE 	4 2	19x70 19x70	2339 2278
EB1 EB2	EAVE BOARD - RÄYSTÄSLAUTA - TAKFOTSBRÄDE 	2 10	19x90 19x90	2348 1976
EB3 EB4	EAVE BOARD - RÄYSTÄSLAUTA - TAKFOTSBRÄDE 	5 8	19x90 19x90	1950 1001
EB5 EB6	EAVE BOARD - RÄYSTÄSLAUTA - TAKFOTSBRÄDE 	2 2	19x120 19x90	2348 1373
CB1 CB2	CORNER BOARD - KULMANLAUTA - HÖRNBRÄDE 	2 6	19x90 19x90	2090 2040
CB3	CORNER BOARD - KULMANLAUTA - HÖRNBRÄDE 	2	19x90	569
CB4	CORNER BOARD - KULMANLAUTA - HÖRNBRÄDE 	2	19x90	569
FIL1	FILLING BOARD- TÄYTTÖLAUTA- FYLLNADSBRÄDE 	2	16x80	2060
FIL2	FILLING BOARD- TÄYTTÖLAUTA- FYLLNADSBRÄDE 	2	16x70	2060



2 PAKKI L<2.35m

Pos	P3939-16 Sylvania	Nr. Pcs.	Profile (mm)	L (mm)
	DOOR HANDLE - OVEN KAHVA - DÖRR HANDTAG 	1		
	DOOR LOCK+KEYS - OVENLUKKO+AVAIN - DÖRRLAS+NYCKLAR 	1		
	WINDOW HANDLE - IKKUNA KAHVA - FÖNSTER HANDTAG 	1+1+1		
	STEEL CORNER - KULMARAUTA - VINKELJÄRN 	10	90x90	65
	STEEL PLATE - METALLILEVY - METALLPLATTA 	2 2	2,5x60 2,5x60	160 120
	NAILS - NAULAT - SPIKAR  FERMS - KATTOPARRU - TAKLÄGGNING	108	5,0	120
	NAILS - NAULAT - SPIKAR  FLOORBOARD - LATTIALAUTA - GOLVBRÄDE	700	2,5	60
	NAILS - NAULAT - SPIKAR  ROOFBOARD - KATTOLAUTAT - TAKBRÄDE	32	2,0	40
	NAILS - NAULAT - SPIKAR  SKIRTING SLAT - LATTIALISTA - GOLVLIST			
	SCREW - RUUVIT - SKRUVAR  ELEMENT - ELEMENT - ELEMENTTI EL-9 & EL-10 EL-11 & EL-12	18	5,0	120
	SCREW - RUUVIT - SKRUVAR  FLOORBEAMS - LATTIAPALKIT - GOLVBÄLJKAR	225	4,5	70
	SCREW - RUUVIT - SKRUVAR  ELEMENT CONNECTING - ELEMENTTI YHDISTAMIS - ELEMENT SAMMANSLAGNING	40	5,0	40
	SCREW - RUUVIT - SKRUVAR  STEEL PLATE - METALLILEVY - METALLPLATTA			
	SCREW - RUUVIT - SKRUVAR  STEEL CORNER - KULMARAUTA - VINKELJÄRN EAVE BOARD - RÄYSTÄSLAUTA - TAKFOTSBRÄDE CORNER BOARD - KULMANLAUTA - HÖRNBRÄDE GABLE BOARD - KAAPELILAUTA - GAVELBRÄDA GABLE SLAT - KAAPELILISTA - VINDLIST ROOF FELT FILLET - KATON PÄÄTYLAUTA - BRÄDE OVANPÅ GAVELBRÄDE	370	4,5	45

WS-1

WATER SILL

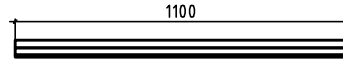
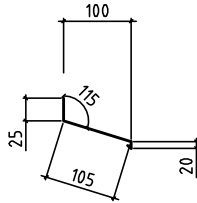

2



Polhus

Kood P3939-16 Sylvania

Materjal

File P3939-16 Sylvania.dwg

Leht 3/3



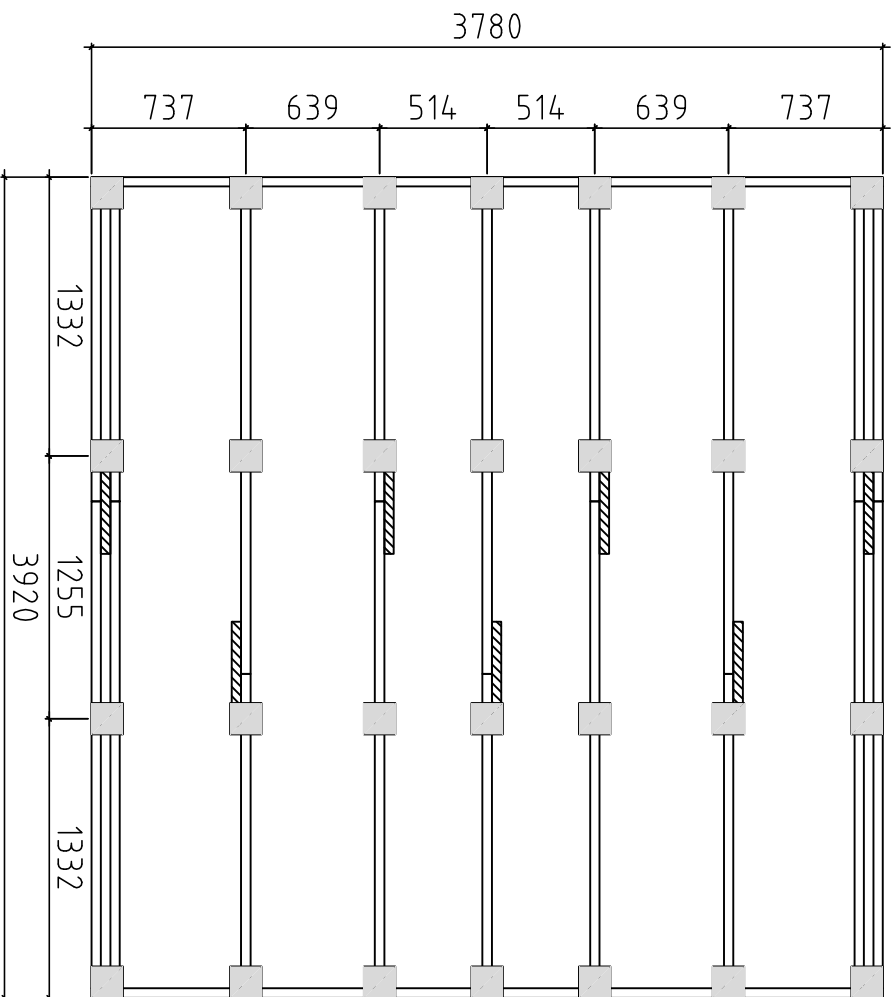

Detta är ett förslag för hur man kan placera piltarna (100-200 mm i diameter) för golvvägglaget. Golvväggarna är med i byggsatsen, men inte piltarna. Använder man exempelvis 500-600mm långa murblock så kan man halvera antalet punkter. Lägg fuktskyddande papp mellan betong och trä

Tämä on ehdotus siitä, miten (100-200 mm läpimittaiset) jalat voidaan sijoittaa alapohjaa varten. Lattiapaikit ovat rakennussarjassa, mutta jalat ei ole. Kun käytetään esimerkiksi 500-600 mm pitkiä harkkoja, voidaan pisteiden määrä puolittaa. Aseta betonin ja puun väliin kosteudelta suojaava paperi

A proposal for placing pilthts (100-200 mm in diameter) for floor beams. Floor beams are provided in the kit but pilthts are not included. For example, by using 500-600 mm long masonry units, one can reduce the number of points 50%. Place cardboard between the concrete and wood to protect from moisture

Date rev. Description

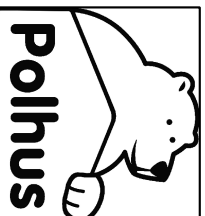

House	P3939-16 Sylvia	Sheet	
Drawing	Plan	Scale	1:35
Material		Date	18.01.2016
Drawer	K.K.	File	P3939-16 Sylvia.dwg