

Jenny
Art. Nr. 199000
1/7

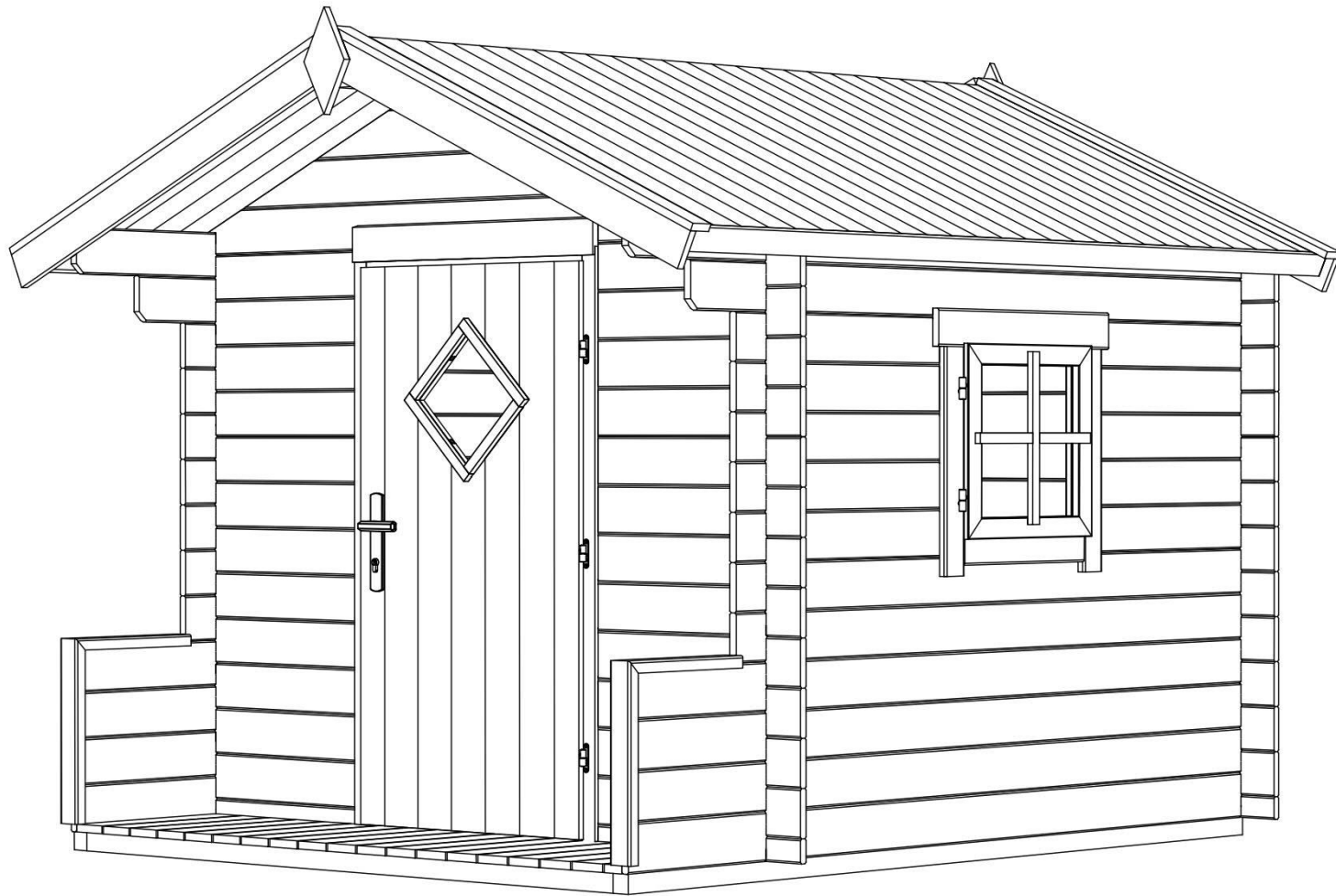

Groundplan - Grundplan - Plan de masse - Planimetria -
Plattegrond - Põhiplaan

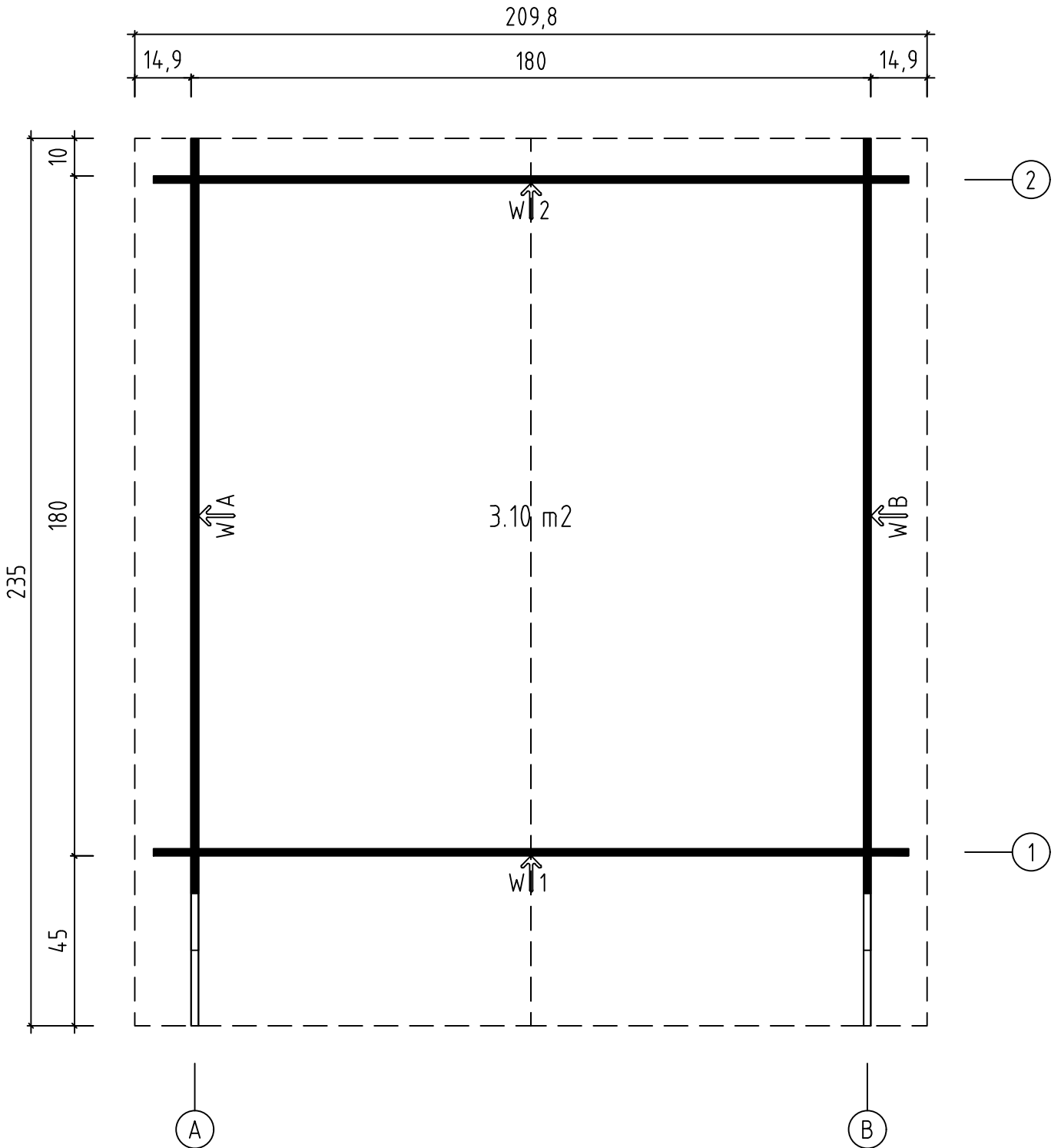

Art. Nr. 199000

Foundation - Fundament - Fondation - Fondamenta - Fundering -
Immutatud alusraam

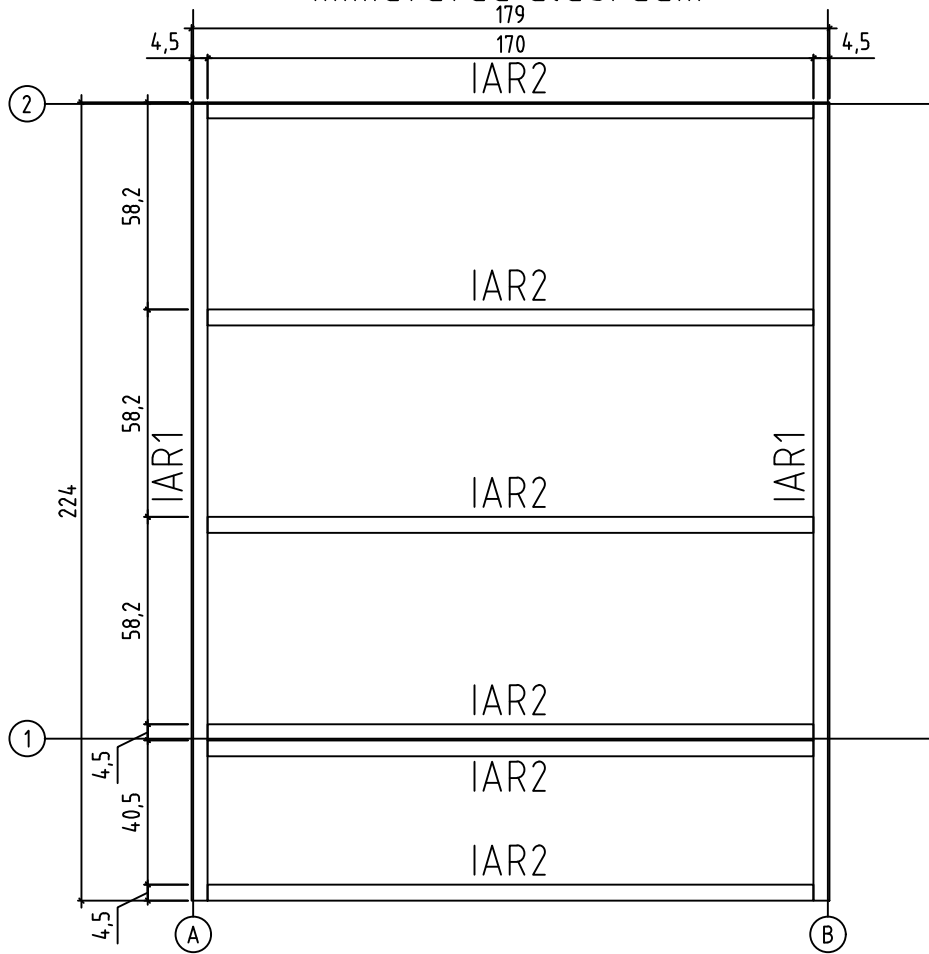

Floor boards - Fussbodenbretter - Plan pose plancher - Pavimento -
Vloerhout - Põrandalaudis

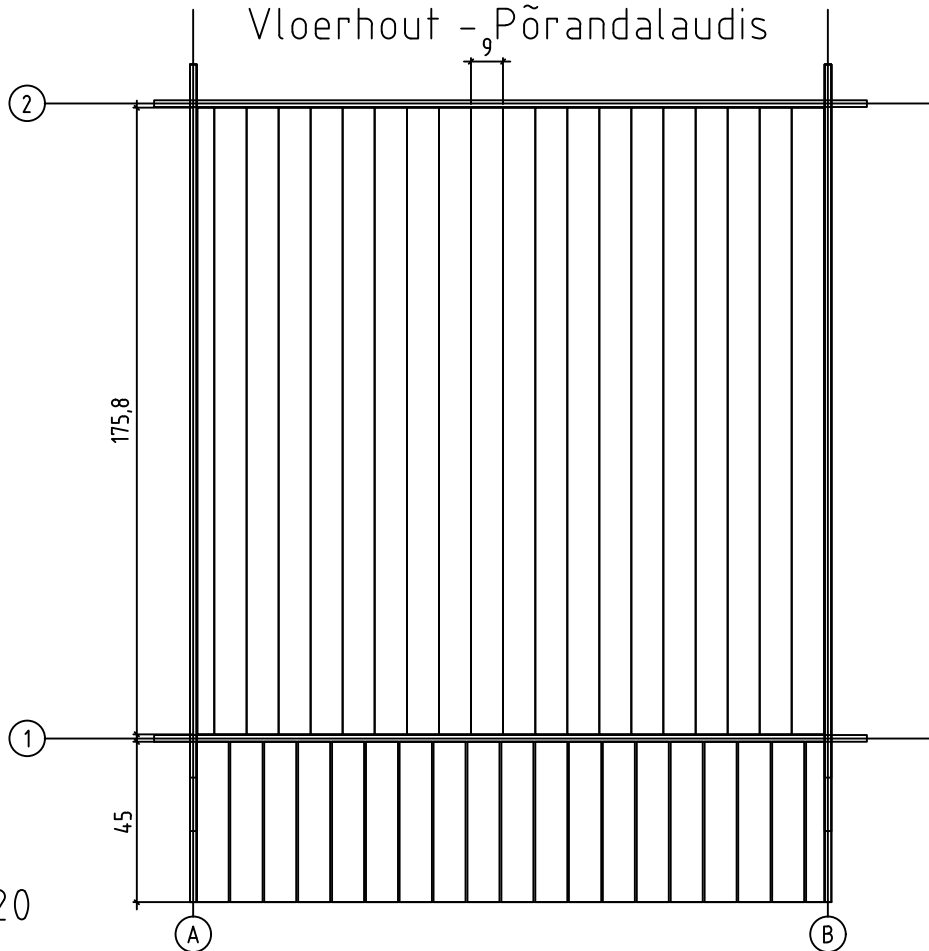

04.12.2020

3/7



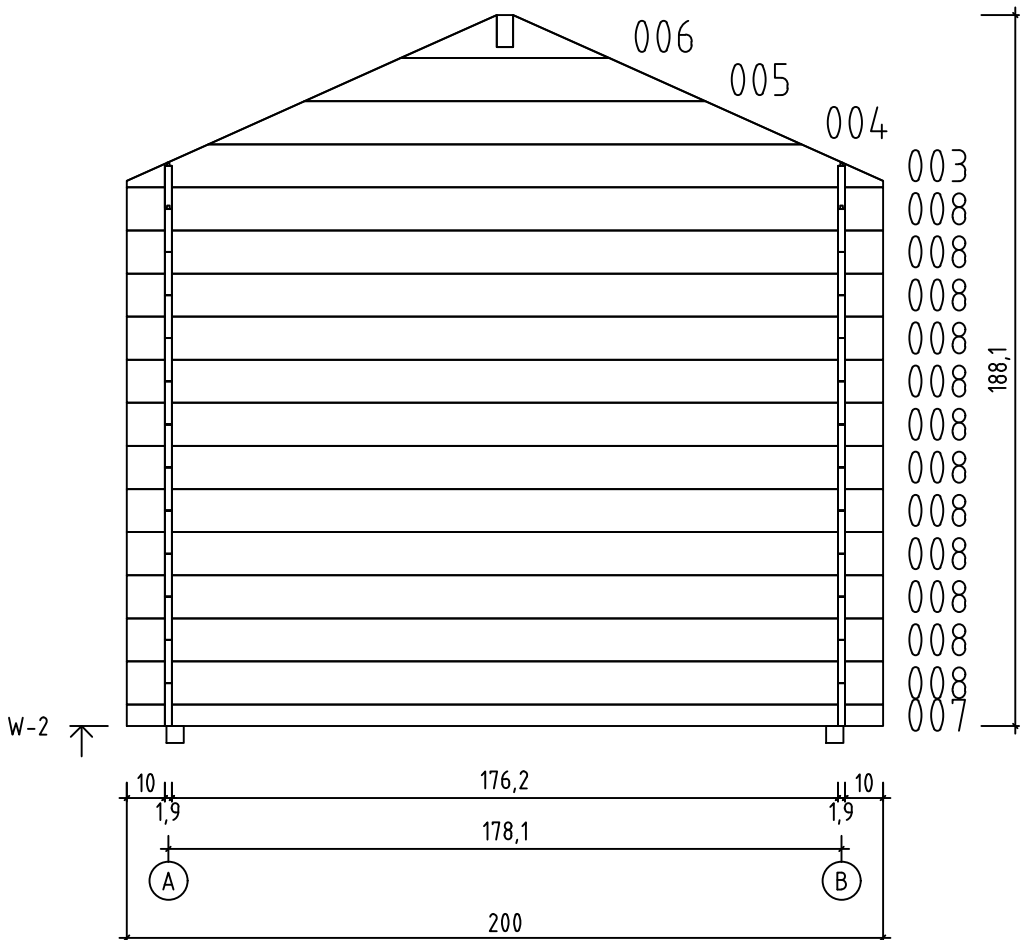
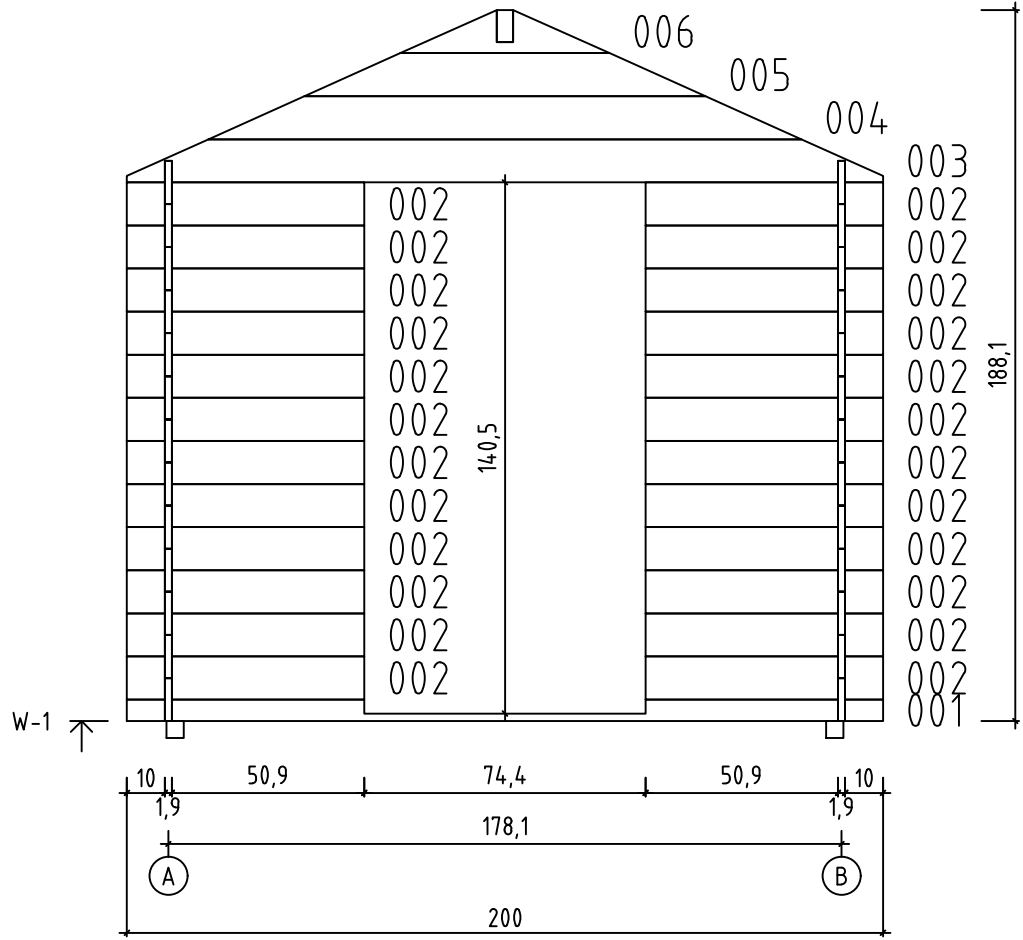

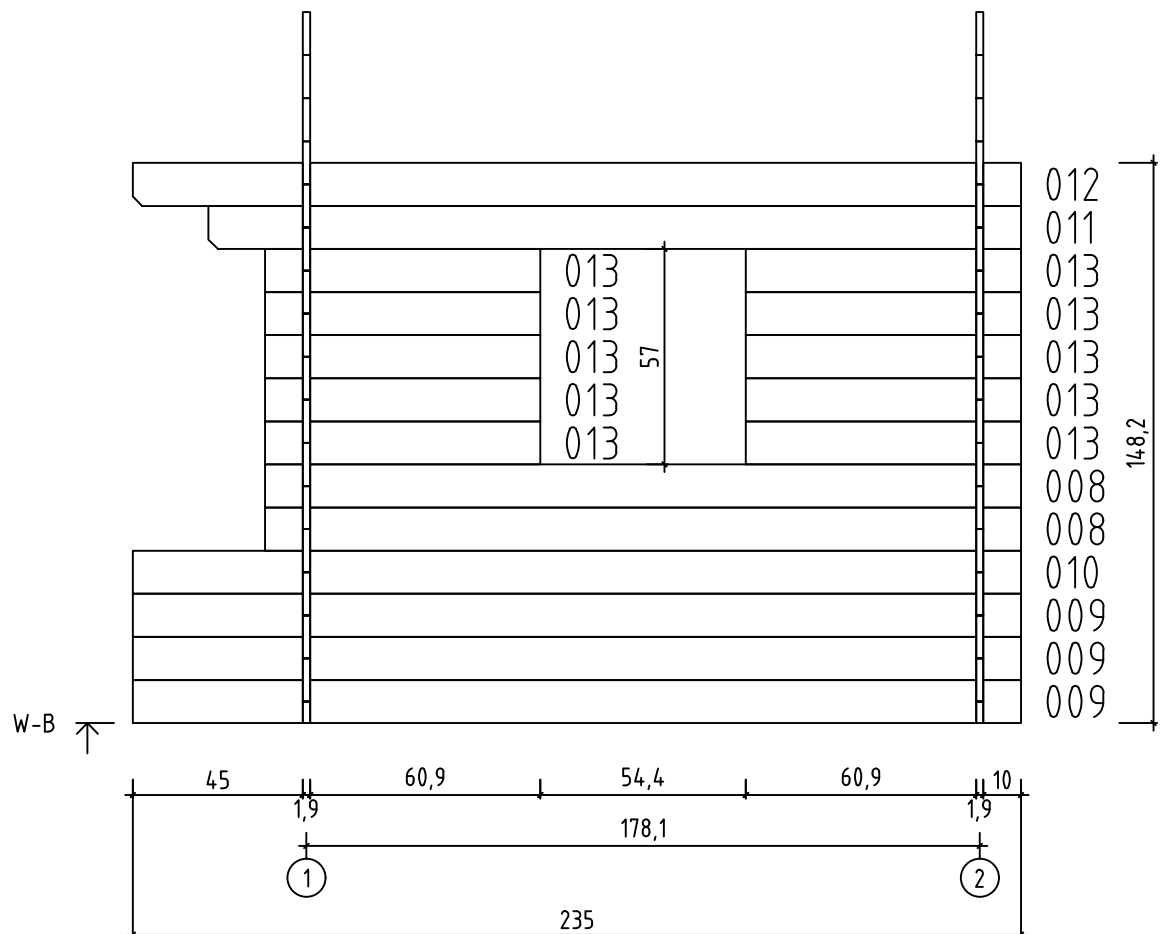
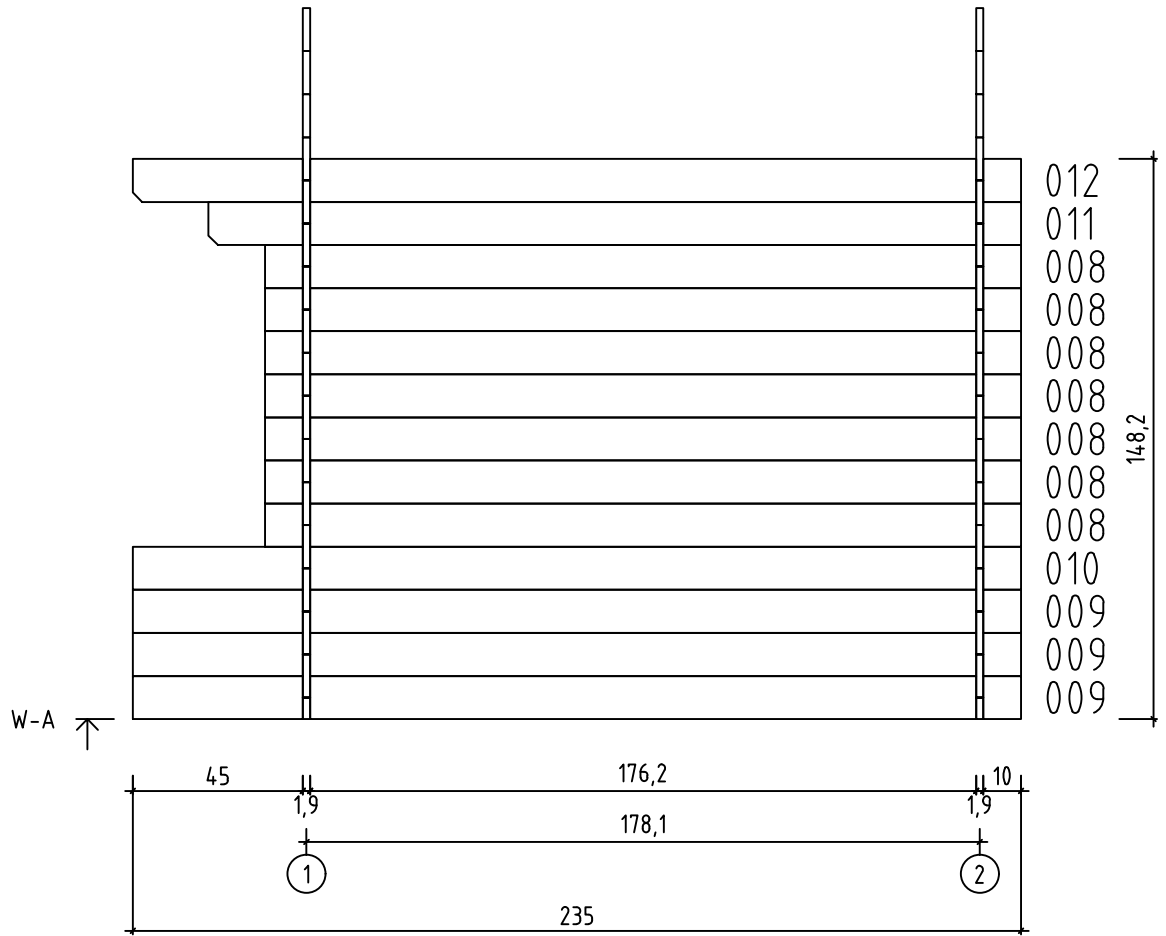

Art. №. 199000



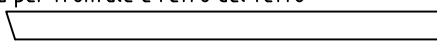
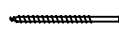

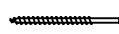
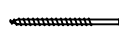
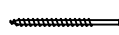
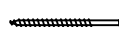
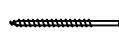

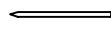
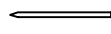
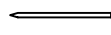
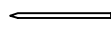
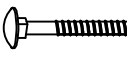



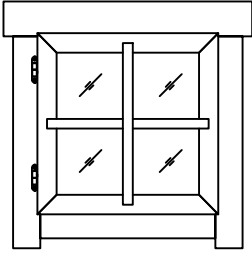
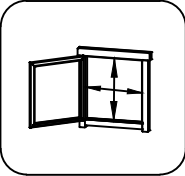
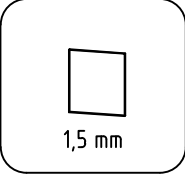

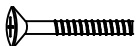
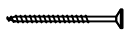

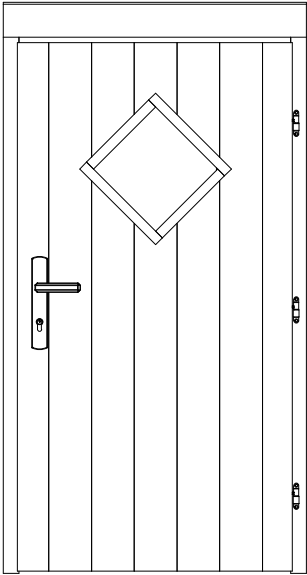
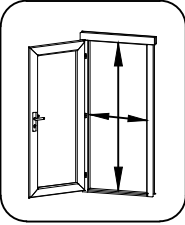
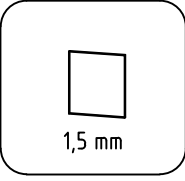
Art. №. 199000



Pos	04.12.2020 Piece list - Stückliste - Liste des pièces - Elementi - Stuklijst - Tükitalabel Art. Nr. 199000 6/7	Q	P (mm)	L (mm)
001		1	19x57	2000
002		24	19x114	628
007		1	19x57	2000
008		21	19x114	2000
009		6+1	19x114	2350
010		2	19x114	2350
011		2	19x114	2150
012		2	19x114	2350
013		10	19x114	728
W1-1 W2-1		1 1		
IAR1	Foundation - Fundament - Fondation - Fondamenta - Fundering - Immutatud alusraam 	2	45x45	2240
IAR2	Foundation - Fundament - Fondation - Fondamenta - Fundering - Immutatud alusraam 	6	45x45	1700
A-PR1	Roof beam - Dachbalken - Panne de toit - Perlina del tetto - Gordingen / dakbalk - Pärilin 	1	44x95	2350
	Floor boards - Fussbodenbretter - Lame de plancher - Pavimento - Vloerhout - Põrandalaud 	20	90x18	1758
	Terrace boards - Terrassenbretter - Plancher de terrasse - Piattaforme terrazzo - Terrasvloer - Terrassilaud 	19	90x19	450
	Roof boards - Dachbretter - Voliges - Perlina per tetto - Dakhout - Katuselaud 	54	90x18	1150
	Floor fillet - Fussbodenleiste - Corniere de finition du plancher - Finitura per pavimento (battisco pa) - Vloerafwerklijst - Põrandaliist 		18x18	8
	Roofing felt fillet - Dachpappenleiste - Baguette de fixation du feutre bitumeux - Asse per fissaggio guaina bituminosa - Afdekljst asfaltpapier - Katusepapiilist 	4	18x58	1200
TB-1	Fascia board - Traufbrett - Bandeau de toit - Finitura lati tetto - Gevellijst - Räästalaud 	2	18x58	2350
KFS-1	Storm protection - Sturmleiste - Latte anti-tempeste - Protezione anti vento - Stormverankering / beveliging - Tormikinnitusliist 	4	22x45	2050
	U-profile - U-profits - Profile u - Profilo ad u - U-profiel - U-profiil 	2	28x58	368
	U-profile - U-profits - Profile u - Profilo ad u - U-profiel - U-profiil 	2	28x58	454

Pos	04.12.2020 Piece list - Stückliste - Liste des pièces - Elementi - Stuklijst - Tükítabel Art. Nr. 199000 7/7	Q	P (mm)	L (mm)
	Gable moulding - Giebelleiste - Planche de rive - Finitura per frontale e retro del tetto - Gevellijst - Viilulaud 	4	18x120	
HS8	Screw for gable segment - Schrauben für deckblatt - Vis pour fixation losange de finition - Viti x frontali tetto - Schroef voor gevelpunt segment - Kruvi rombile 	4	3.5x35	
HS9	Screw for u-profile - Schraube zur befestigung u-profilen - Vis a tete fraisée pour profil u - Vite per profilo ad u - Schroef ter bevestiging u-profiel - Kruvi U-profiilile 	8	3.5x50	1200
HS9	Screw for gable moulding - Schrauben für giebelleiste - Vis pour fixation planche de rive - Vite per fissare finiture davanti e dietro del tetto - Schroef voor gevellijst - Kruvi viilulauale 	16	3.5x50	
HS12	Screw for fascia boards - Schrauben für traufbretter - Vis pour fixation bandeau de toit - Viti x striscia del tetto - Schroef voor gevellijst - Kruvi räästalauale 	12	4x40	
HS18	Screw for roof beams - Schrauben für dachbalken - Vis pour fixation pannes de toit - Viti per perline del tetto - Schroef voor gordingen / dakbalken - Kruvi pärlinitele 	2	5x120	
HS18	Screw for gable - Schrauben für giebel - Vis pour fixation des pignons - Viti per timpano - Schroef voor gevelpunt - Kruvi viilude kinnitamiseks 	4	5x120	
HS16	Screw for foundation - Schrauben zur befestigung fundament - Vis de fixations des poutrelles de fondations - Viti x fundamenta - Schroef voor fundering - Kruvi alusraamile 	12	5x90	
HS16	Screw for foundation - Schrauben zur befestigung fundament - Vis de fixations des poutrelles de fondations - Viti x fundamenta - Schroef voor fundering - Kruvi alusraamile 	2	5x90	
SH19	Hammer block - Schlagholz - Calte de frappe - Blocco di legno da usare come cuscinetto quando si usa il martello - Stagklos - Löögiklots 	1		
SFS	Nut for storm protection - Schraubenmutter für sturmleiste - Ecrou pour latte anti-tempete - Dado x asta protezione vento - Moer voor stromverankering - Mutter tormikinnitusliistule 	8	D6	
NF3	Zn nail for terrace - Zn nägel für terrassenbretter - Pointe pour plancher de terrasse - Chiodo zincato per terrazza - Spijker(nagel) voor terrasvloer - Nael terrassilauale 	38	2.1x50	
NF4	Zn nail for roof - Zn nägel für dachbretter - Pointe pour fixation voliges de toit - Chiodi x perline tetto - Spijker(nagel) voor dakhout - Nael katuselauale 	116	2x50	
NF4	Zn nail for floor - Zn nägel für fussbodenbretter - Clous pour plancher - Chiodi x perline pavimento - Spijker(nagel) voor vloer - Nael põrandalauale 	84	2x50	
NF5	Zn nail for roofing felt fillet - Zn nägel für dachpappenleiste - Pointe pour baguette de fixation feutre bitumeux - Chiodi x carta bituminosa x tetto - Spijker(nagel) voor asfaltpapier afdeklijst - Papiliistunael 	12	2x40	
BFS	Bolt for storm protection - Bolzen für sturmleiste - Boulon pour latte anti-tempete - Bullone x asta protezione vento - Bout voor stormankerlat - Puidupolt tormikinnitusliistule 	8	6x60	
GS	Gable segment - Deckblatt - Losange de finition - Decorazione in legno x frontale tetto - Gevelpunt segment - Romb 	2		
DFS	Washer for storm protection - Dichtscheibe für sturmleiste - Rondelle pour latte anti-tempete - Rondella x asta protezione vento - Afdichtring voor storm strip - Seib tormikinnitusliistule 	8	D6	
	Window - Fenster - Fenetre - Finestra - Raam - Aken 540x540 AK.1.104.XVV.19d XGC	1		
	Door - Tür - Porte - Porte - Deur - Uks 740x1380 UK.2.030.XVP.MM19b XGZ	1		

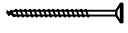
Pos	08.12.2016 Piece list - Stückliste - Liste des pièces - Elementi - Stuklijst - Tükítabel 540x540 AK.1.104.XVV.19d XGC	1/1	Q	P (mm)	L (mm)
	<p data-bbox="260 152 1284 183">Glass size - Glasgröße - Taille de la vitre - Misura del vetro - Glas afmeting - Klaasi mõõt: 382x382 mm</p>   <p data-bbox="1366 349 1493 376">440x440 mm</p>  <p data-bbox="1398 546 1461 573">1,5 mm</p>				
FS1	<p data-bbox="260 1953 1023 2007">Window handle fittings - Fenstergriff - Poignee de fenetre - Maniglia c/ferramenta - Raamhendel -/grendel -/klink - Aknalink</p>		1		
FSP	<p data-bbox="260 2029 1102 2110">Bolt for window handle fittings - Bolzen für fenstergriff beschlag - Vis pour fixation poignee de fenetre - Bullone x apertura manuale finestra - Schroef voor raamhendel - Akna käepideme polt</p>		2		
HS1	<p data-bbox="260 2119 1102 2199">Screw for georgian bars - Schraube für sprossen - Vis pour croisillons - Viti per unire la griglia georgiana della finestra - Schroeven voor raamverdeling - Kruvi akna petfeliistule</p>		4	2.5x20	

Pos	Piece list - Stückliste - Liste des pièces - Elementi - Stuklijst - Tükítabel 14.01.2015 740x1380 UK.2.030.XVP.MM19b XGZ	1/4	Q	P (mm)	L (mm)
	<p>Glass size - Glasgröße - Taille de la vitre - Misura del vetro - Glas afmeting - Klaasi mõõt: 246x246 mm</p>   <p>700x1360 mm</p>  <p>1,5 mm</p>				
	Upper door jamb - Türrahmen oben - Cadre de porte supérieur - Telaio superiore della porta - Bovendorpel - Ukse ülemine leng		1	42x40	740
	Right door jamb - Türrahmen rechts - Cadre de porte droit - Telaio montante destro della porta - Rechterstijl deurframe - Ukse prem leng		1	42x40	1400
	Left door jamb - Türrahmen links - Cadre de porte gauche - Telaio montante sinistro della porta - Linkerstijl deurframe - Ukse vasak leng		1	42x40	1400
	Doorstep - Swelle - Seuil de porte - Callare - Drempel - Lävepakki ukseavale		1	15x21	740
	Fillet - Leiste - Lattes - Massello - Lijst - Liist		2	15x25	276
	Fillet - Leiste - Lattes - Massello - Lijst - Liist		2	15x25	226
	Covering moulding - Deckungsprofil - Profils de finition verticaux a fixer a l'exterieur du cadre de la porte - Cornice di finitura - Afdek profiel - Lengi piirdelaud		1	18x90	780
	Glass - Glas - Vitre - Vetro - Glas - Klaas		1	246x246	
HS2	Screw for window fillet - Schraube für glasteile - Vis de fixation d'encadrement vitrage - Vite per assemblaggio finestra - Schroef voor glaslijst - Kruvi klaasiliistule		8	2.5x25	
HS2	Screw for covering moulding - Schrauben für deckungsprofil - Vis de fixation profils horizontaux haut intérieur et extérieur d'encadrement de porte - Vite per cornice di copertura - Schroef voor afdekprofiel - Kruvi piirdelaude		4	2.5x25	
HS2	Screw for fixing door to the wall - Schraube zur Befestigung für - zarge mit wand - Vis de fixation partie basse dormants de porte au 1er rang de madrier - Viti per fissare la porta alla parete - Schroef voor bevestiging deur naar wand - Kruvi ukseleangi kinnitamiseks seinale		2	3.5x35	

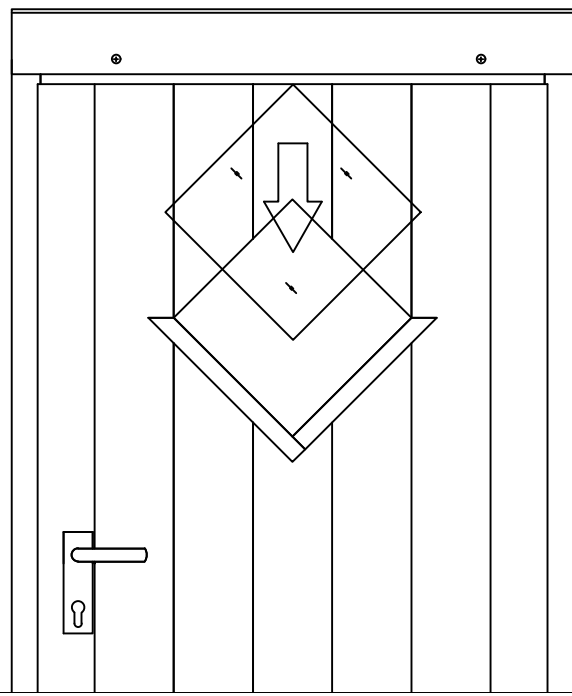
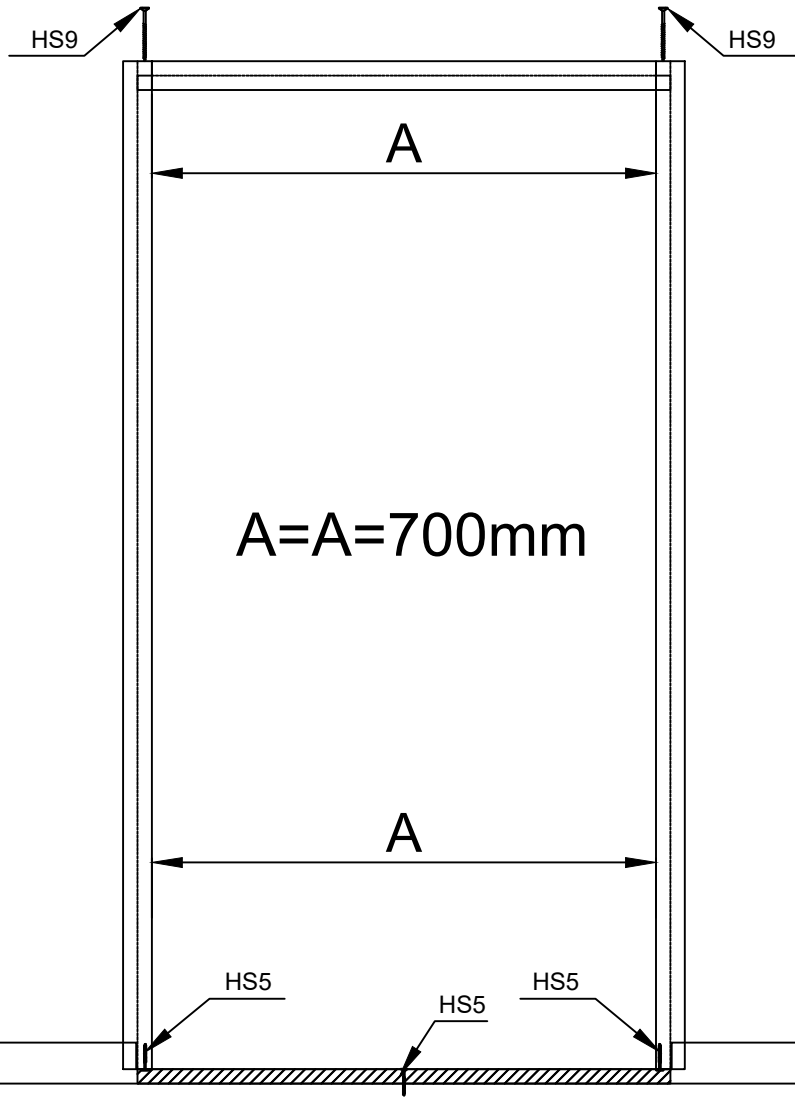

Pos

14.01.2015

Piece list - Stückliste - Liste des pièces - Elementi - Stuklijst - Tükitabel
740x1380 UK.2.030.XVP.MM19b XGZ

4/4

Q

P
(mm)

L
(mm)

