

P3330-28 Majvi

# Views and ground plan - Julkisivut ja pohjapiirustus - Fasader och grundplan

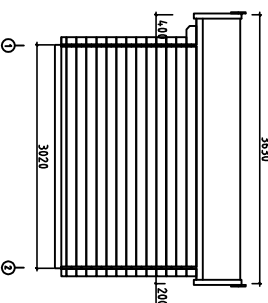
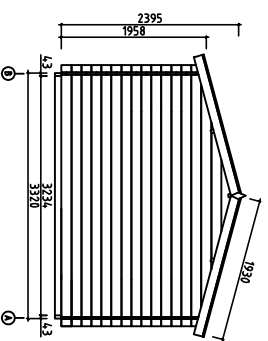
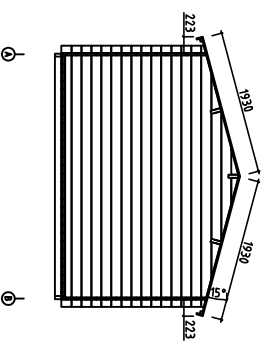
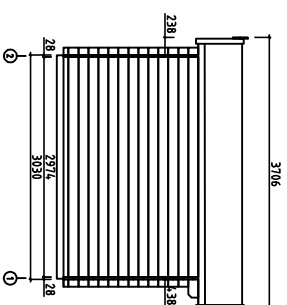
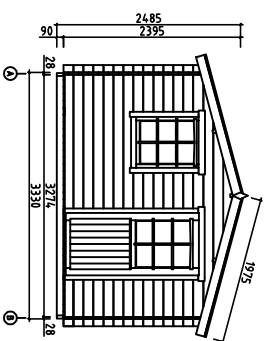
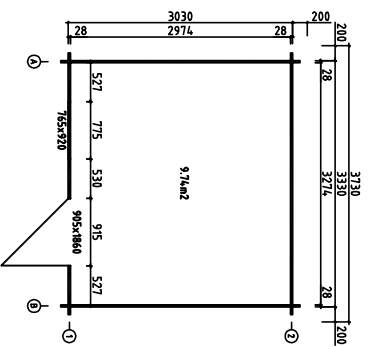
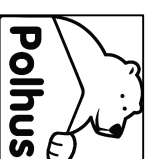

Roof Pmax=160kg/m<sup>2</sup>  
V 1,0

		House	P3330-28 Majvi	Sheet	1
		Drawing	VIEWS	Scale	1:100
		Material	28x135	Date	11.03.2016
		Drawer	K.K.	File	P3330-28 Majvi views.dwg

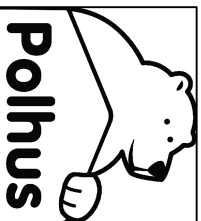
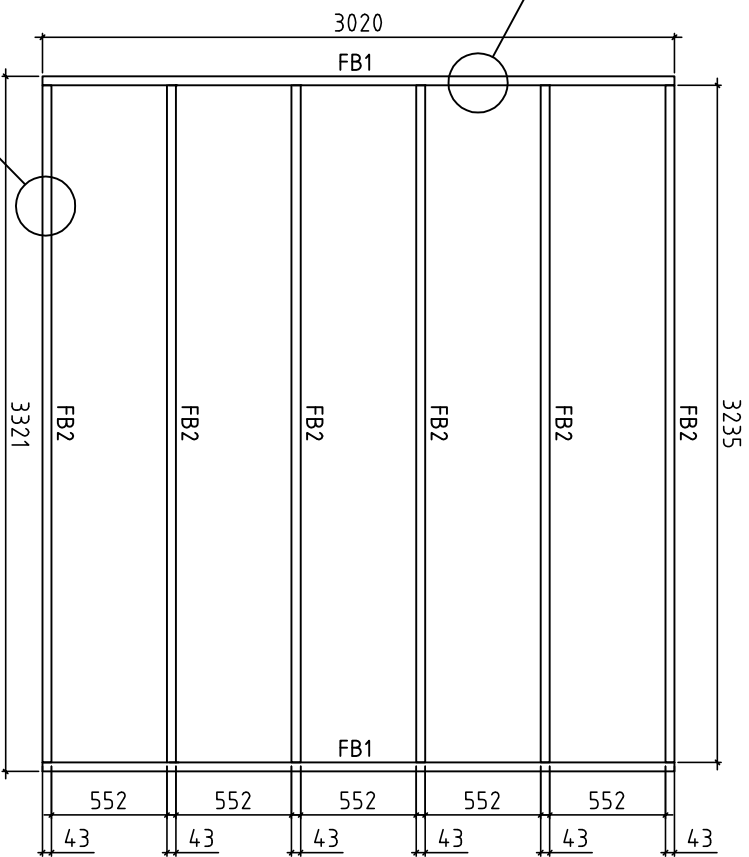

House	P3330-28 Majvi	Sheet	2
Drawing	FLOORBEAMS	Scale	1:35
Material	4.3x90	Date	21.11.2014
Drawer	K.K.	File	P3330-28 Majvi.dwg

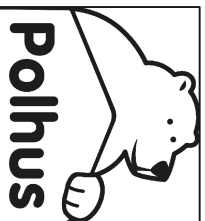
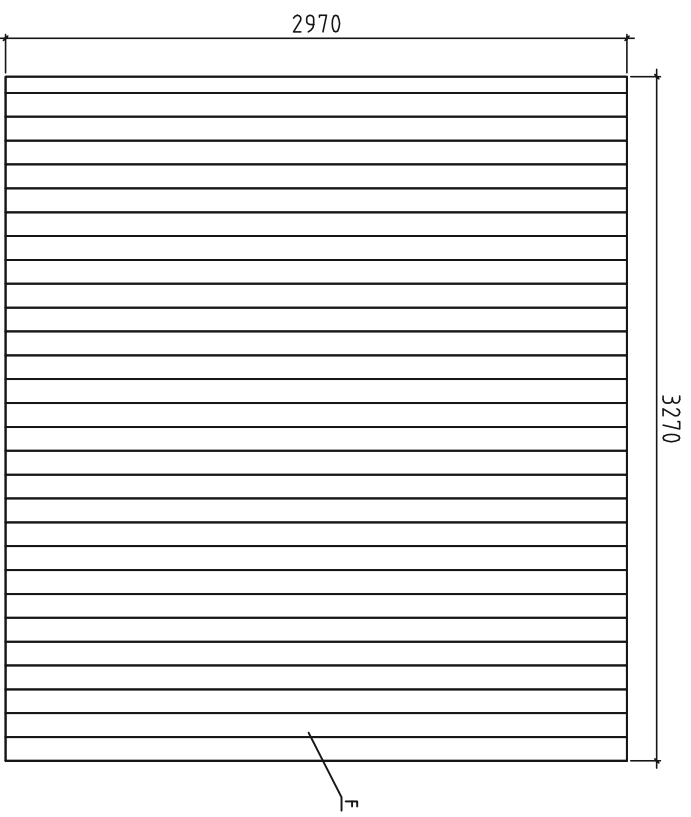

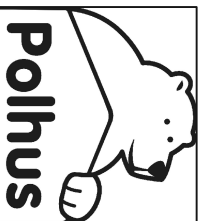
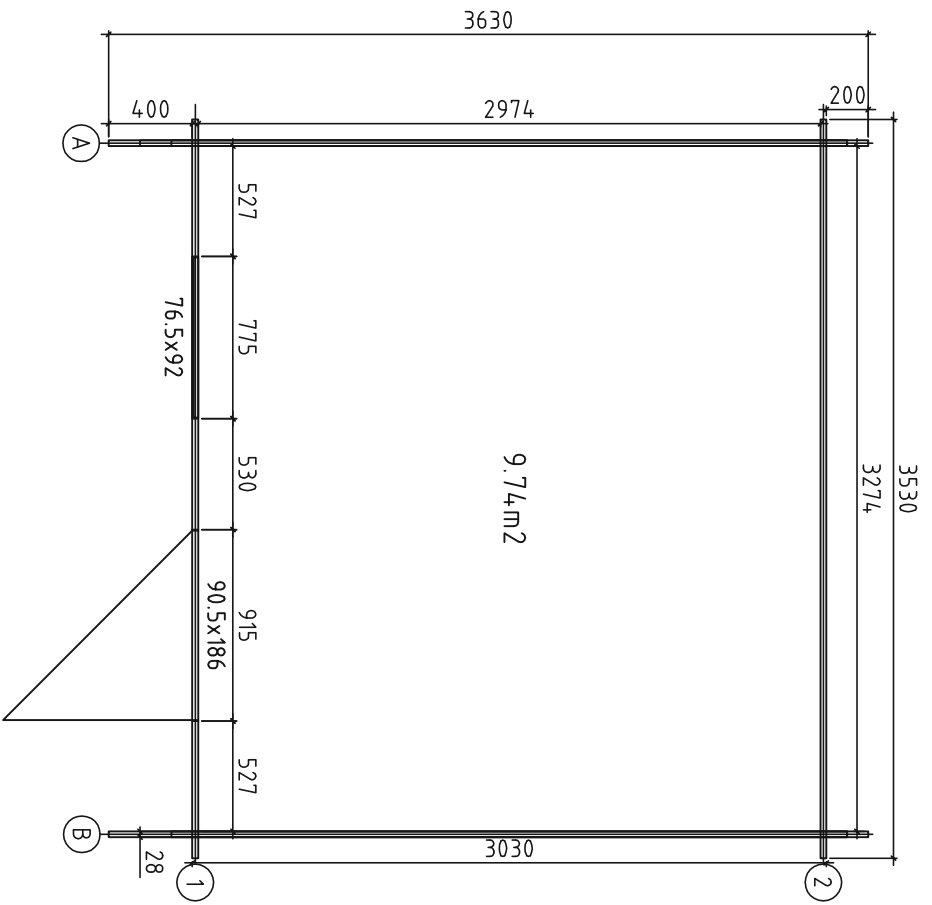

House	P3330-28 Majvi	Sheet	3
Drawing	FLOORBOARD	Scale	1:35
Material	114x19	Date	21.11.2014
Drawer	K.K.	File	P3330-28 Majvi.dwg



House	P3330-28 Majvi	Sheet	4
Drawing	Groundplan	Scale	1:35
Material	28x135	Date	21.11.2014
Drawer	K.K.	File	P3330-28 Majvi.dwg

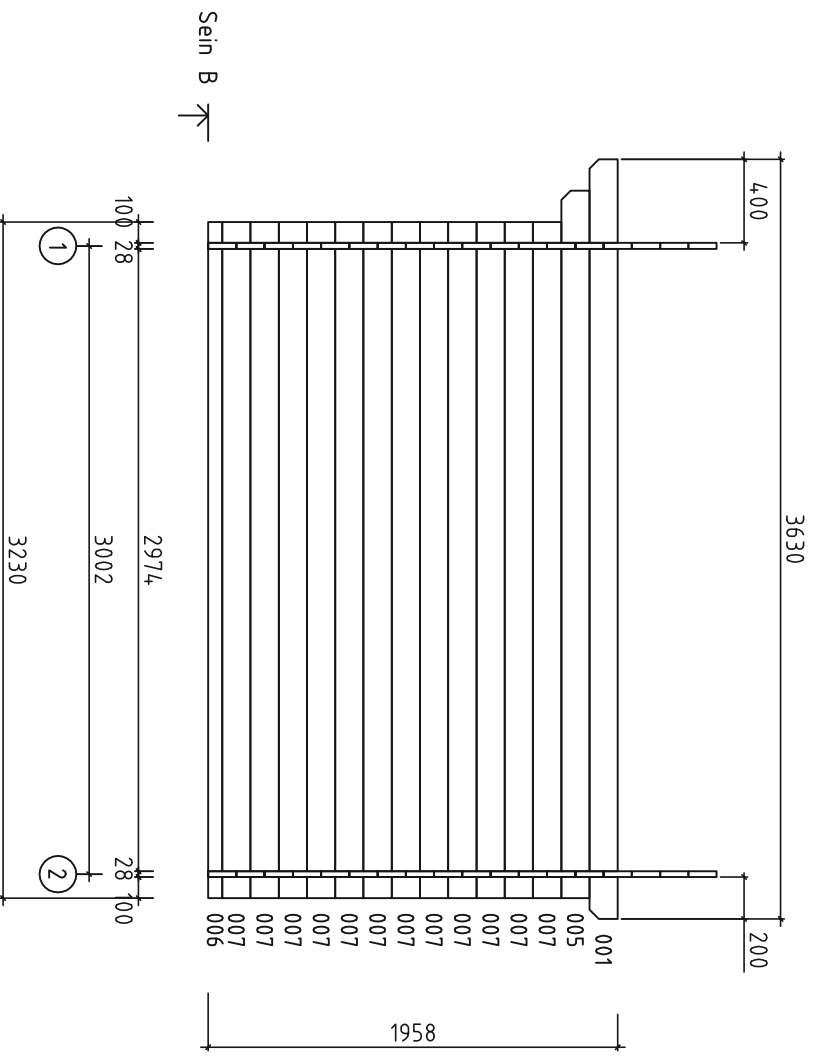



			
House	P3330-28 Majvi	Sheet	6
Drawing	WALL B	Scale	1:35
Material	2.8x13.5	Date	19.11.2014
Drawer	K.K.	File	P3330-28 Majvi.dwg





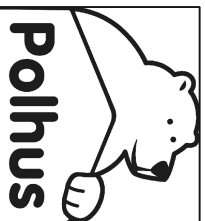
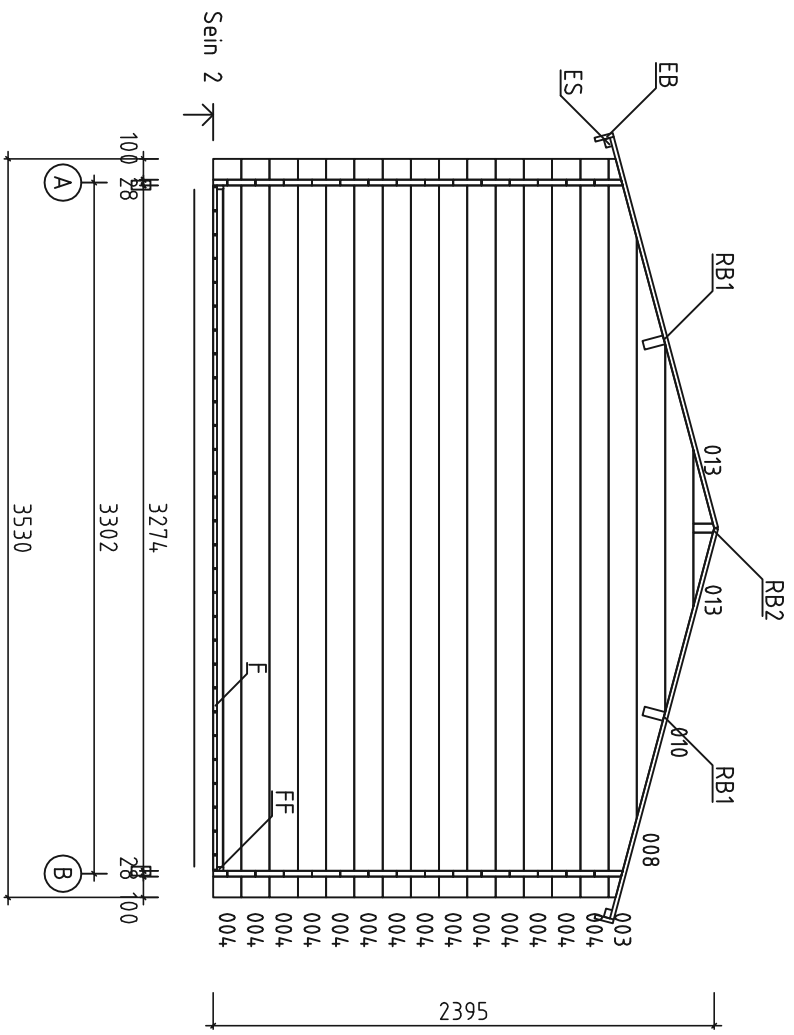

House	P3330-28 Majvi	Sheet	8
Drawing	WALL 2	Scale	1:35
Material	2.8x13.5	Date	19.11.2014
Drawer	K.K.	File	P3330-28 Majvi.dwg

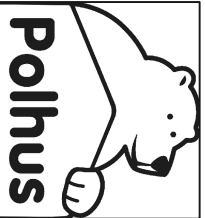
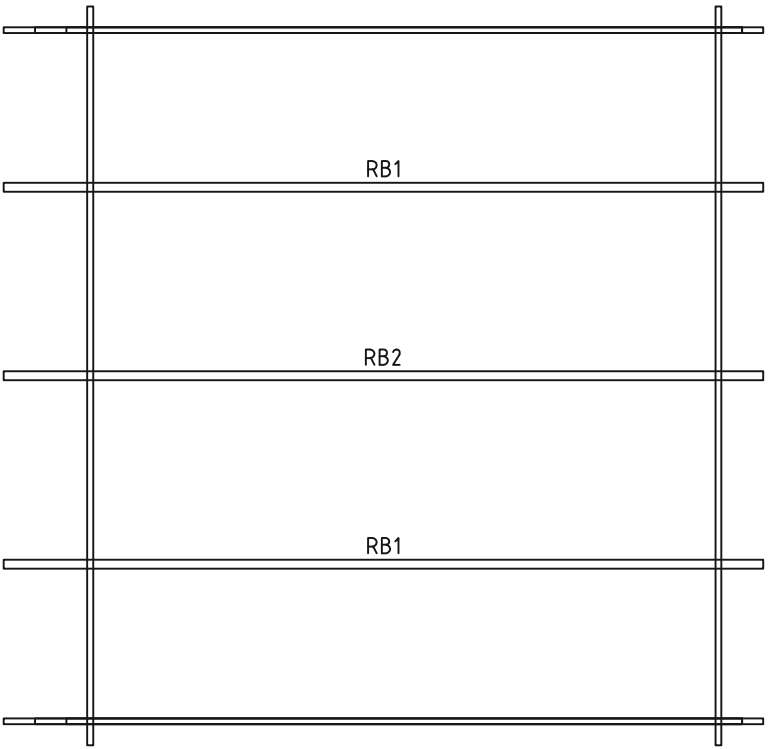

House	P3330-28 Majvi	Sheet	9
Drawing	PURLINS	Scale	1:35
Material	4,3X14,0	Date	21.11.2014
Drawer	K.K.	File	P3330-28 Majvi.dwg

Pos	P3330-28 Majvi	St.	Profil (mm)	L (mm)	
001		1	28x135	3630	
002		1	28x135	3630	
003		2	28x135	3530	
004		14	28x135	3530	
005		2	28x135	3380	
006		2	28x68	3230	
007		24	28x135	3230	
008		2	28x135	2769	
009		7	28x135	1960	
010		2	28x135	1759	
011		21	28x135	655	
012		7	28x135	530	
013		4	28x94	353	
SB		EXTRA PROFILE	1	28x135	3530
	BOARD FOR ASSEMBLING - ASENNUSLAUTA - SLAGBRÄDE	2	28x135	300	
W1-1		1	28x499	3530	
W2-1		1	28x499	3530	
FB2	FLOORBEAM-LATTIAPALKIT-GOLVBÄLKAR	6	43x90	3235	
FB1	FLOORBEAM-LATTIAPALKIT-GOLVBÄLKAR	2	43x90	3020	
RB1	PÖHIPÄRLINID	2	43x140	3630	
RB2	PÖHIPÄRLINID	1	43x140	3630	
F	FLOORBOARD-LATTIALAUTA-GOLVBRÄDE  88mm or -tai- eller 114mm	38+1 29+1	88x19 114x19	2970	
R	ROOFBOARD-KATTOLAUTA-TAKBRÄDE  88mm or -tai- eller 114mm	84+1 64+1	88x19 114x19	1930	













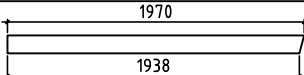

Polhus

Kood P3330-28 Majvi

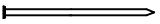
Materjal

File P3330-28 Majvi.dwg

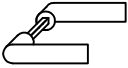
Leht 10

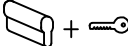
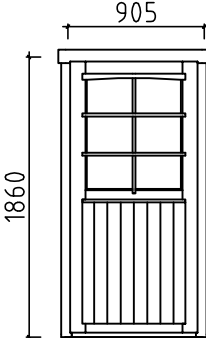
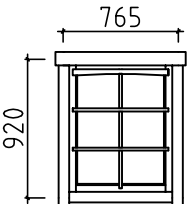
Pos	P3330-28 Majvi	St.	Profil (mm)	L (mm)
FF	FLOOR FILLET-LATTIALISTA-GOLVLIST 		18x30	13.0
GB	GABLE BOARD-KAAPELILAUTA-GAVELBRÄDA 	4	19x120	1970
EB	EAVE BOARD-RÄYSTÄSLAUTA-TAKFOTBRÄDE 	2	19x90	3630
ES	EAVE SLAT-RÄYSTASLISTA-TAKFOTLIST 	2	30x40	3630
RFF	ROOF FELT FILLET - KATON PÄÄTYLAUTA - BRÄDE OVANPÅ GAVELBRÄDE 	4	19x70	1980
D	DECORATIVE - KORISTE - PRYDNADS 	2	19x100	200
	NAILS - NAULAT - SPIKAR  FLOORBOARD - LATTIALAUTA - GOLVBRÄDE ROOFBOARD - KATTOLAUTAT - TAKBRÄDE	535	2,5x60	
	NAILS - NAULAT - SPIKAR  FLOORBEAMS - LATTIAPALKIT - GOLVBJÄLKAR	40	5,0x100	
	SCREWS - RUUVIT - SKRUVAR  ROOF FELT FILLET-KATON PÄÄTYLAUTA-BRÄDE OVANPÅ GAVELBRÄDE SKIRTING SLAT - LATTIALISTA - GOLVLIST	45	3,5x35	
	SCREWS - RUUVIT - SKRUVAR  EAVE BOARD - RÄYSTÄSLAUTA - TAKFOTSBRÄDE EAVE SLAT - RÄYSTASLISTA - TAKFOTSLIST GABLE BOARD - KAAPELILAUTA - GAVELBRÄDA TERRACE BOARD - TERRASILAUTA - TERASSBRÄDE	345	4,5x50	
	SCREWS - RUUVIT - SKRUVAR  FIXING HALF BEAMS VAHVISTETTAVA PUOLIKKAAT PALKIT FÖR ATT FASTA HALVA VÄGGPROFILER	10	4,5x90	
	DOOR CROSSES-OVIRISTIKKO-SPRÖJS 	1		
	DOOR HANDLE-OVEN KAHVA-DÖRR HANDTAG 	1		
	WINDOW CROSSES-IKKUNARISTIKKO-SPRÖJS 	1		
	WINDOW HANDLE-IKKUNA KAHVA-FÖNSTER HANDTAG 	1		
	DOOR LOCK+KEYS-OVENLUKKO+AVAIN-DÖRRLÅS+NYCKLAR 	1+1		
	 DOOR - OVI - DÖRR 905x1860 1 set - kpl - st (right hand - oikea käsi - höger hand) AST_ISO_VA P.P.	1	905	1860
	 WINDOW - IKKUNAN - FÖNSTER - 765x920 1 set - kpl - st (right hand - oikea käsi - höger hand) AST_ISO_KP P.P.	1	765	920

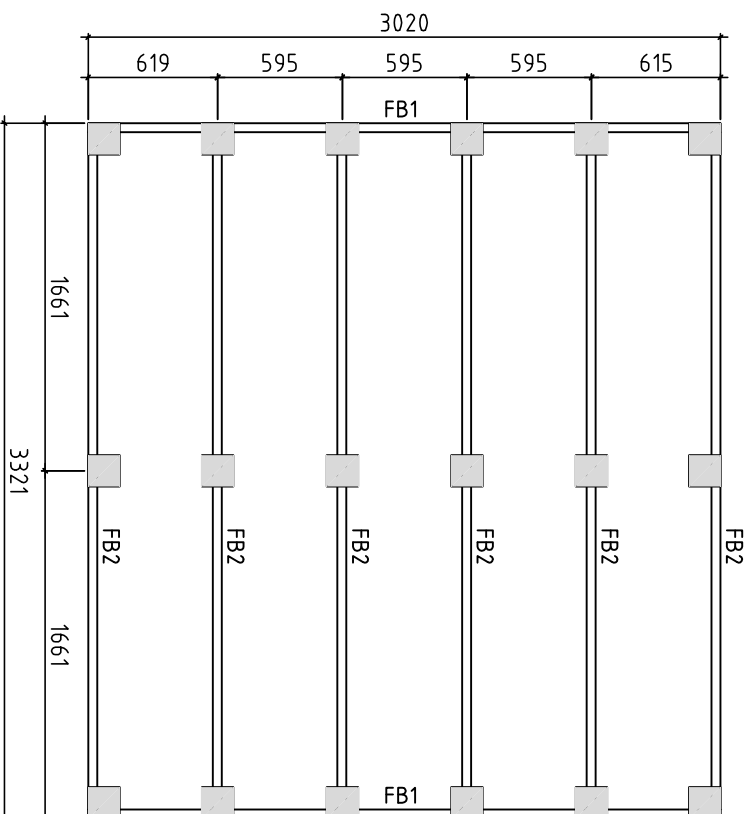

Detta är ett förslag för hur man kan placera plintarna (100- 200 mm i diamaten) för golvväggsklaget. Golvväggsklagen är med i byggsatsen, men inte plintarna. Använder man exempelvis 500-600mm långa murblock så kan man halvera antalet punkter. Lägg fuktskyddande papp mellan betong och trä

Tämä on ehdotus siitä, miten (100-200 mm läpimittaiset) jalat voidaan sijoittaa alapohjan varten. Lattiapakit ovat rakennussarjassa, mutta jalat ei ole. Kun käytetään esimerkiksi 500-600 mm pitkiä harkkoja, voidaan pisteiden määrä puolittaa. Aseta betoniin ja puun väliin kosteudelta suojaava paperi

A proposal for placing plinths (100-200 mm in diameter) for floor beams. Floor beams are provided in the kit but plinths are not included. For example, by using 500-600 mm long masonry units, one can reduce the number of points 50%. Place cardboard between the concrete and wood to protect from moisture

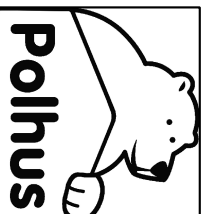

**Polhus**

House	P3330-28 Majvi	Sheet	12
Drawing	Plan	Scale	1:35
Material		Date	11.03.2016
Drawer	K.K.	File	P3330-28 Majvi.dwg