

Views and ground plan - Fasader och grundplan - Julkisivut ja pohjapiirustus

Roof MAX 100kg/m2

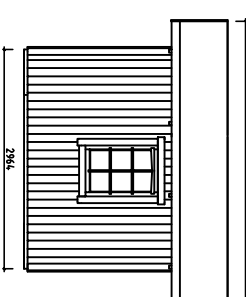

EB1
EB3
EB1

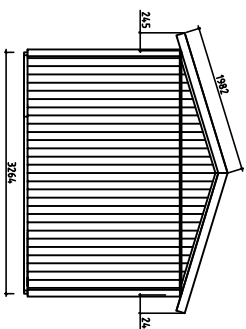
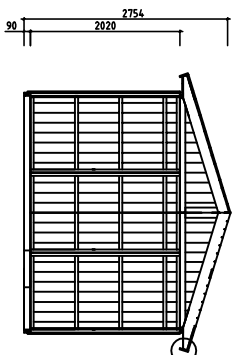
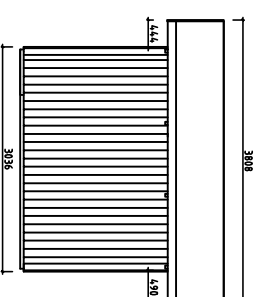
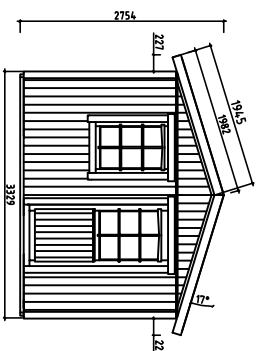
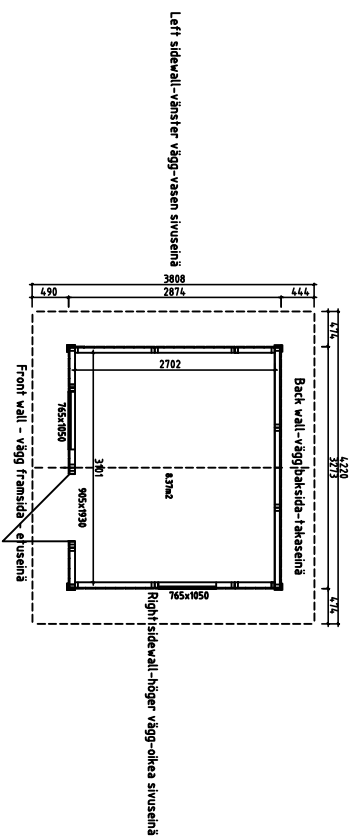
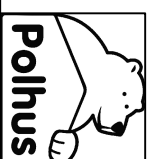
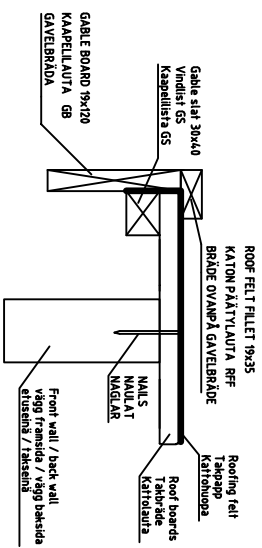

House	E3330-16 Björkö	Sheet	1
Drawing	Views-fasader-julkisivut	Scale	1:100
Material		Date	19.02.2016
Drawer	K.K.	File	E3330-16 Björkö.dwg

V 1.0

Date rev. Description

Overview description of the manual – Översikts beskrivning för monteringen – Kokoonpano – ohjeiden kuvaminen

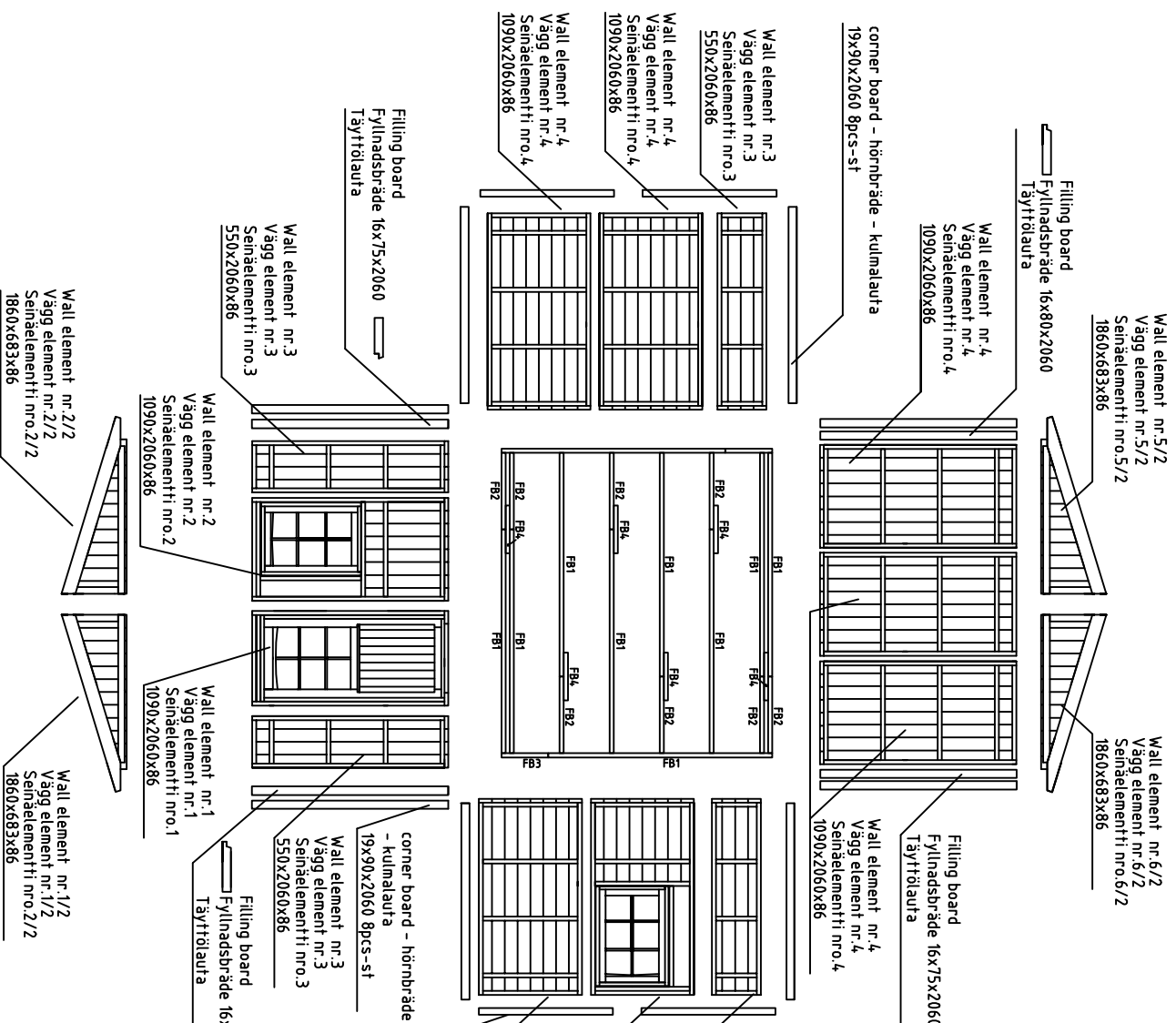

Wall element nr. 2/2
Vägg element nr. 2/2
Seinälementti nr. 2/2
1860x683x86

Wall element nr. 1/2
Vägg element nr. 1/2
Seinälementti nr. 1/2
1860x683x86

Wall element nr. 2
Vägg element nr. 2
Seinälementti nr. 2
1090x2060x86

Wall element nr. 1
Vägg element nr. 1
Seinälementti nr. 1
1090x2060x86

corner board – hörnbräde
– kulmalautta
19x90x2060 8pcs-st

Wall element nr. 3
Vägg element nr. 3
Seinälementti nr. 3
550x2060x86

Filling board
Fyllnadsbräde 16x80x2060
Täyttölauta

Sidewall connecting
beam SCB
Bjälkar för sidovägg
sammanslagning
Sivuseinä yhdistämisspalkit
70x43x1421

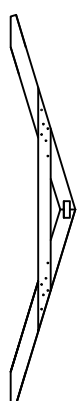

Ferns 2pcs
Takläggning 2st
Kattoparrut 2kpl
rev. Description

2350	Roofboard 40pcs (19x114), or 50pcs (19x88) Takbräde 40st (19x114) och 50st (19x88)	
1420	Kattolautta 40kpl (19x114) tai 50kpl (19x88)	
1615	Floorboard 28pcs (19x114), or 36pcs (19x88) Golvräde 28st (19x114) och 36st (19x88)	
1085	Lattilautta 28kpl (19x114) tai 36kpl (19x88)	
2350	Floorboard 28pcs (19x114), or 36pcs (19x88) Golvräde 28st (19x114) och 36st (19x88)	
1420	Lattilautta 28kpl (19x114) tai 36kpl (19x88)	
2350	Eave boards 4pcs 19x120 Takfotsbräde 4st 19x120	
1420	Räystäslautta 4kpl 19x120	
2350	Eave boards 4pcs 19x120 Takfotsbräde 4st 19x120	
1420	Räystäslautta 4kpl 19x120	
2180	Gable slat 4pcs 30x40 Vindlist 4st 30x40	
2171	Kaapeilista 4kpl 30x40	

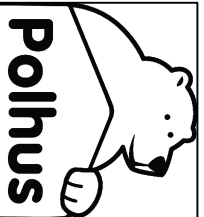

House	E3330-16 Björkö	Sheet	2
Drawing		Scale	1:35
Material		Date	19.02.2016
Drawer	K.K.	File	E3330-16 Björkö.dwg

Installation of floorbeams and floorboards - montering av golvbjälkar samt golvbrädor - lattiapalkkien ja lattialautojen asennus

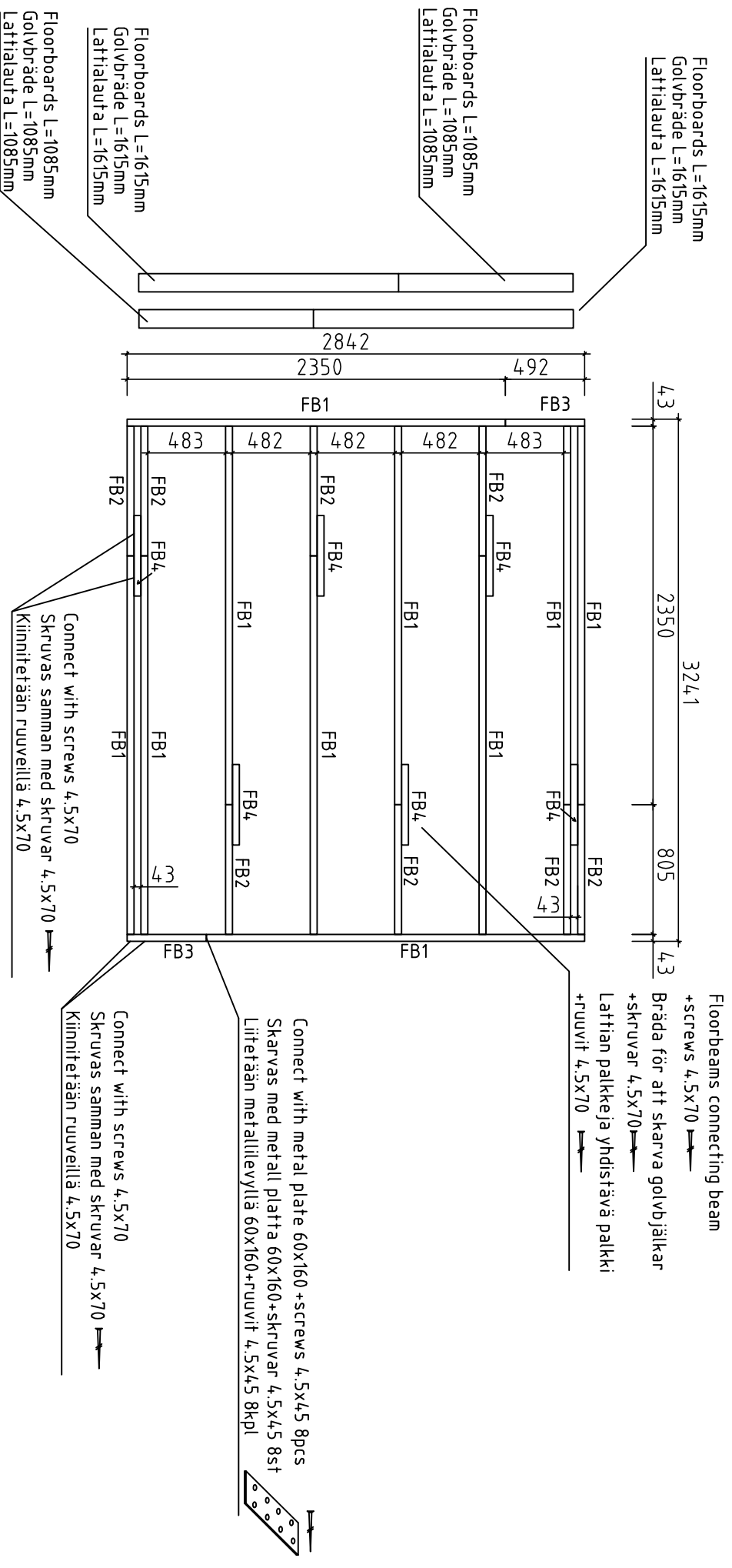

- NB!!! Change the floorboard positions after every row
- NB!!! Skarva golvräderna olika efter varje rad
- NB!!! Muuta lattialautojen sijaintia jokaisen rivin jälkeen

		House	E3330-16 Björkö	Sheet	3
		Drawing	Floorbeams-Golvbjälkar	Scale	1:35
Material	4.5x90	Date	15.12.2015		
Drawer	K.K.	File	E3330-16 Björkö.dwg		

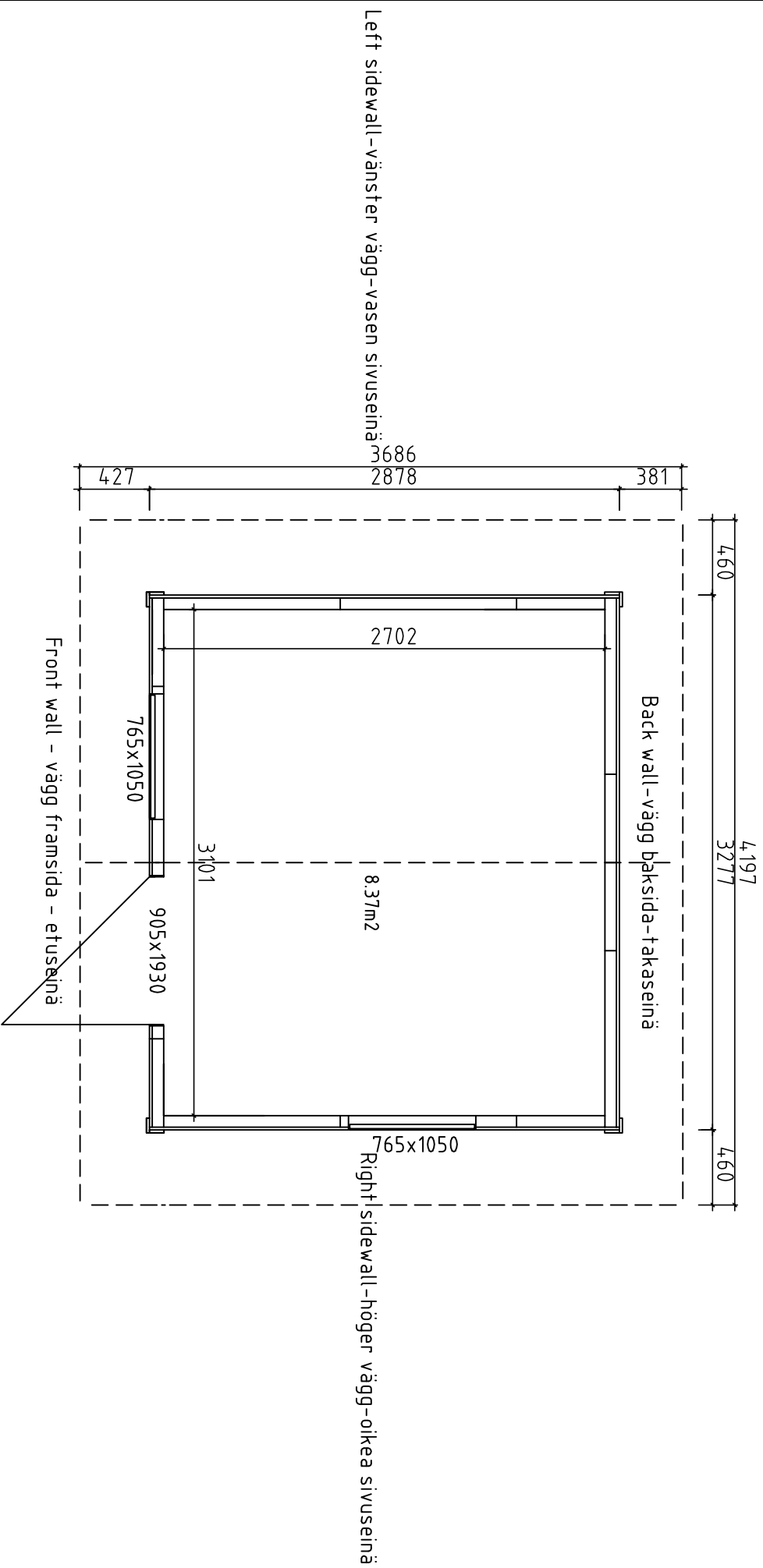

Date rev. Description

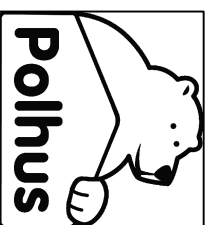

House	E3330-16 Björkö	Sheet	4
Drawing	Ground plan-Grundplan-Pohjapiirustus	Scale	1:35
Material		Date	15.12.2015
Drawer	K.K.	File	E3330-16 Björkö.dwg

Installation of wall element nr.3 - monteringen av vägg element nr.3 - seinäelementin nro.3 asennus

View from inside - Från insidan - Näkyma sisältä

Wall element nr.3
Vägg element nr.3
Seinäelementti nro.3

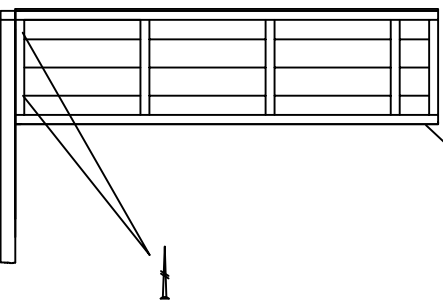

Fix wall element nr.3 with screws
4.5x70 into floorbeam

Fixera vägg element nr.3 med skruvar
4.5x70 i golvbjälke

Kiinnitä seinäelementti nro.3 ruuveilla
4.5x70 lattiapalkkin

Wall element nr.3
Vägg element nr.3
Seinäelementti nro.3

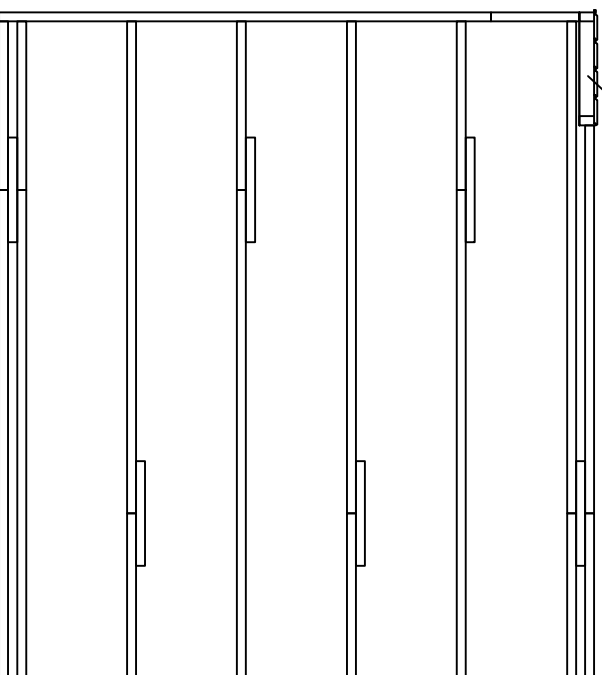

Date rev. Description

 Polhus		House	E3330-16 Björkö	Sheet	5
		Drawing		Scale	1:35
		Material		Date	15.12.2015
Drawer	K.K.	File	E3330-16 Björkö.dwg		

Installation of wall element EL-3 and EL-1 - montering av vägg element EL-3 och EL-1 -seinälementin EL-3 ja EL-1 asennus

View from inside - Från insidan - Näkymä sisältä

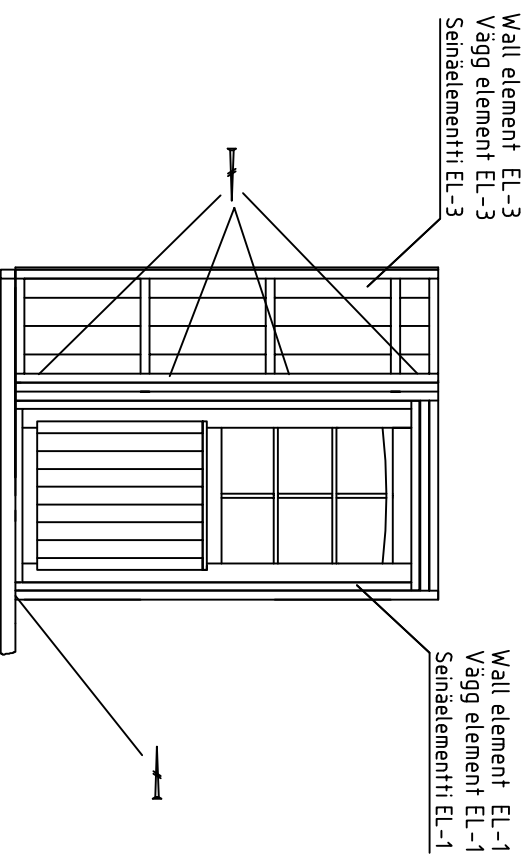

Fix wall element EL-1 with screws

4.5x70 into floorbeam

Fixera vägg element EL-1 med skruvar

4.5x70 i golvbjälke

Kiinnitä seinäelementti EL-1 ruuveilla

4.5x70 lattipalkkin

Fix wall elements EL-3 and EL-1 with screws

4.5x70 together

Fixera vägg element EL-3 och EL-1 med skruvar

4.5x70 tillsammans

Kiinnitä seinäelementit EL-3 ja EL-1

yhteen ruuveilla 4.5x70

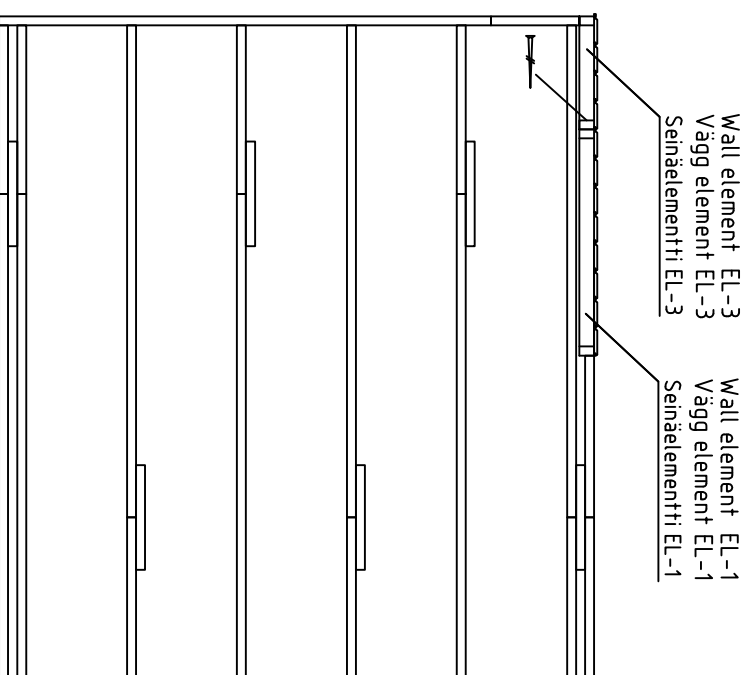

Date rev. Description

 Polhus		House	E3330-16 Björkö	Sheet	6
Drawer	K.K.	Drawing		Scale	1:35
		Material		Date	15.12.2015
		File	E3330-16 Björkö.dwg		

Installation of wall element EL-1 and EL-2 - monteringen av vägg element EL-1 och EL-2 -seinälementin EL-1 ja EL-2 asennus

View from inside - Från insidan - Näkymä sisältä:

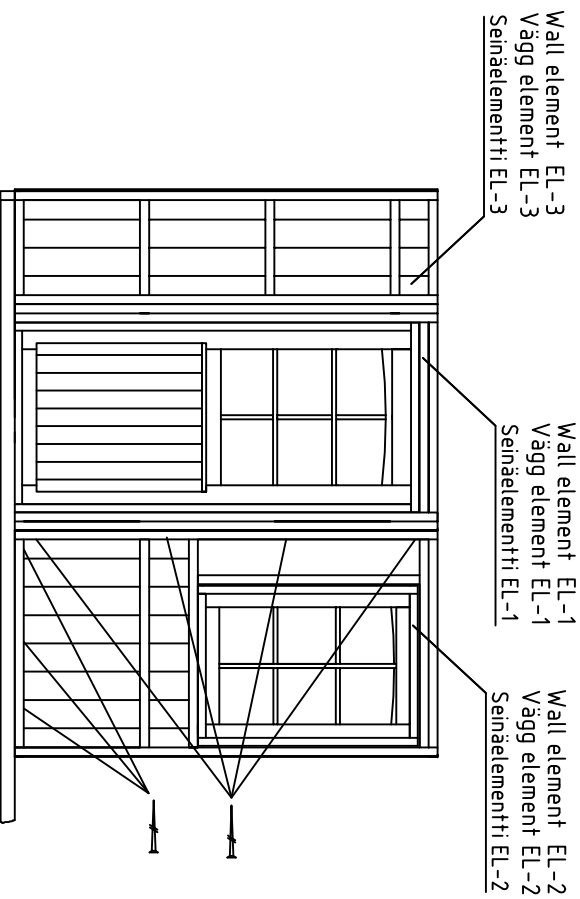

Fix wall element EL-2 with screws

4.5x70 into floorbeam

Fixera vägg element EL-2 med skruvar

4.5x70 i golvbjälke

Kiinnitä seinäelementti EL-2 ruuveilla

4.5x70 lattiapalkkin

Fix wall elements EL-1 and EL-2 with screws

4.5x70 together

Fixera vägg element EL-1 och EL-2 med skruvar

4.5x70 tillsammans

Kiinnitä seinäelementit EL-1 ja EL-2

yhteen ruuveilla 4.5x70

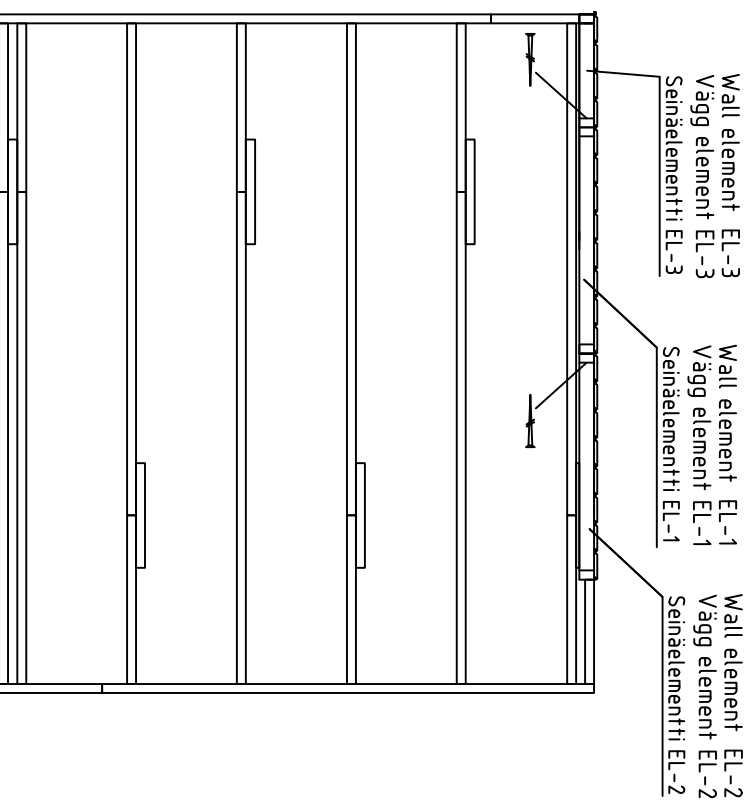

Date rev. Description

	House	E3330-16 Björkö	Sheet	7
	Drawing		Scale	1:35
Material		Date	15.12.2015	
Drawer	K.K.		File	E3330-16 Björkö.dwg

Installation of wall element EL-3 and EL-2 – montering av vägg element EL-3 och EL-2 – seinäelementin EL-3 ja EL-2 asennus

View from inside – Från insidan – Näkymä sisältä:

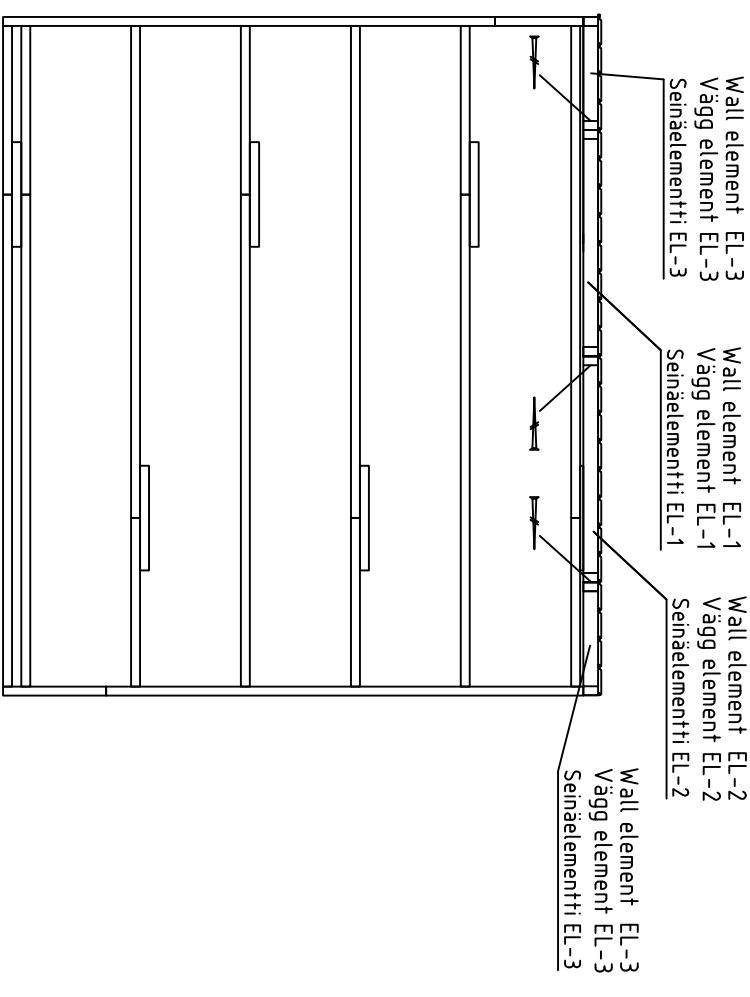
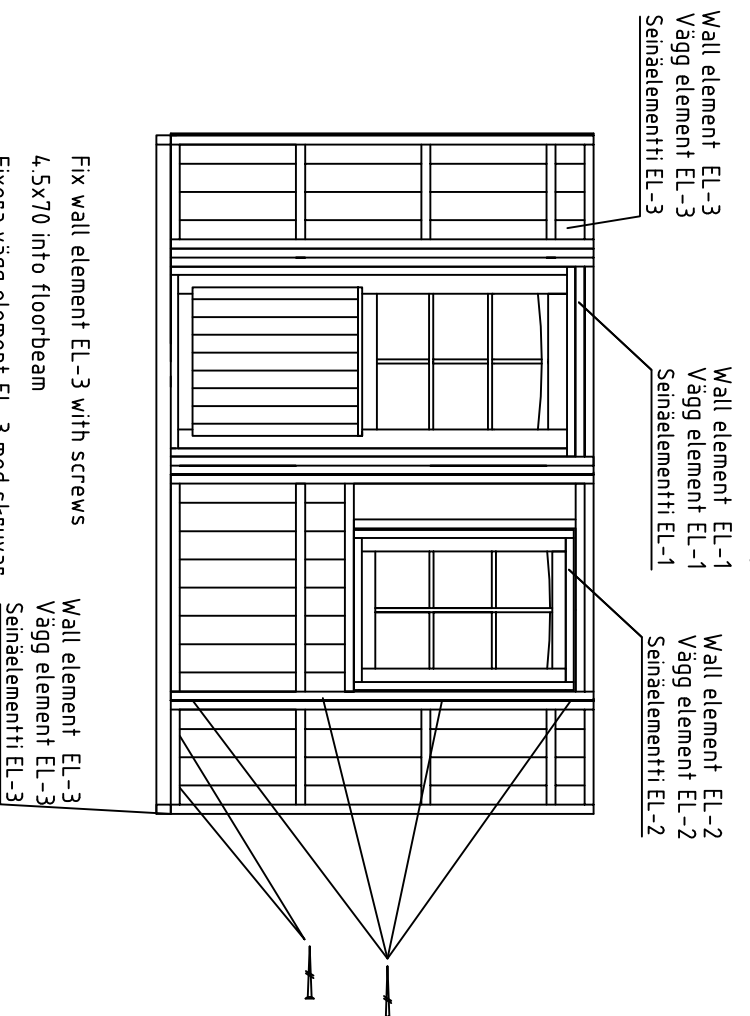

Fix wall element EL-3 with screws

4.5x70 into floorbeam

Fixera vägg element EL-3 med skruvar

4.5x70 i golvbjälke

Kiinnitä seinäelementti EL-3 ruuveilla

4.5x70 lattiapalkkin

Fix wall elements EL-3 and EL-2 with screws

4.5x70 together

Fixera vägg element EL-3 och EL-2 med skruvar

4.5x70 tillsammans

Kiinnitä seinäelementit EL-3 ja EL-2

yhteen ruuveilla 4.5x70

Date rev. Description

	House	E3330-16 Björkö	Sheet	8
	Drawing		Scale	1:35
Material		Date	15.12.2015	
Drawer	K.K.	File	E3330-16 Björkö.dwg	

Installation of left sidewall – montering av vänster sidovägg – vasen sivuseinä asennus

View from inside – Från insidan – Näkymä sisältä:

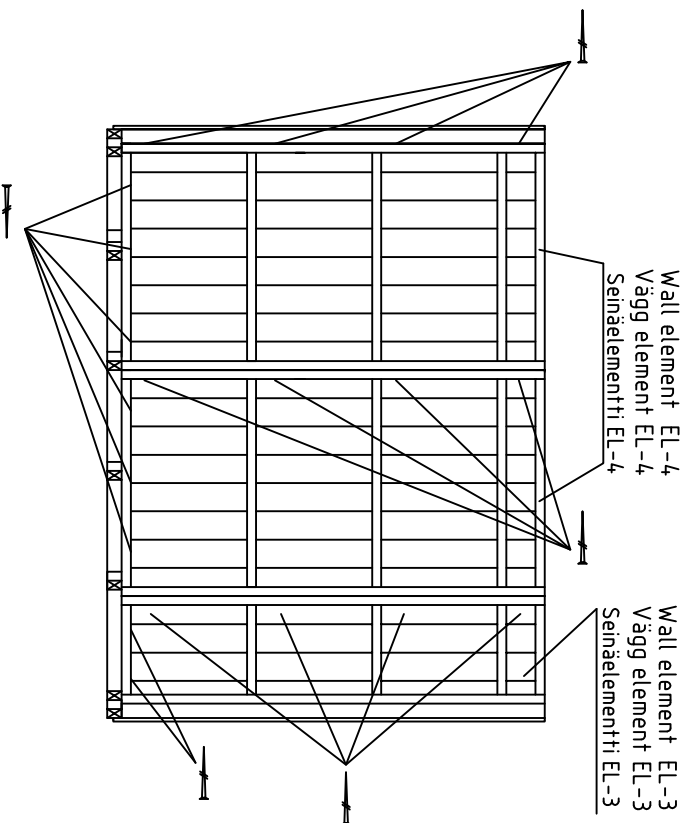

Fix wall element EL-3 and EL-4, EL-4 with screws

4.5x70 into floorbeam

Fixera vägg element EL-3 and EL-4, EL-4 med skruvar

4.5x70 i golvbjälke

Kiinnitä seinäelementti EL-3 and EL-4, EL-4 ruuveilla

4.5x70 lattiapalkkin

Fix wall elements EL-3 and EL-4, EL-4 with screws 4.5x70 together

Fixera vägg element EL-3 and EL-4, EL-4 med skruvar 4.5x70 tillsammans

Kiinnitä seinäelementit EL-3 and EL-4, EL-4 yhteen ruuveilla 4.5x70

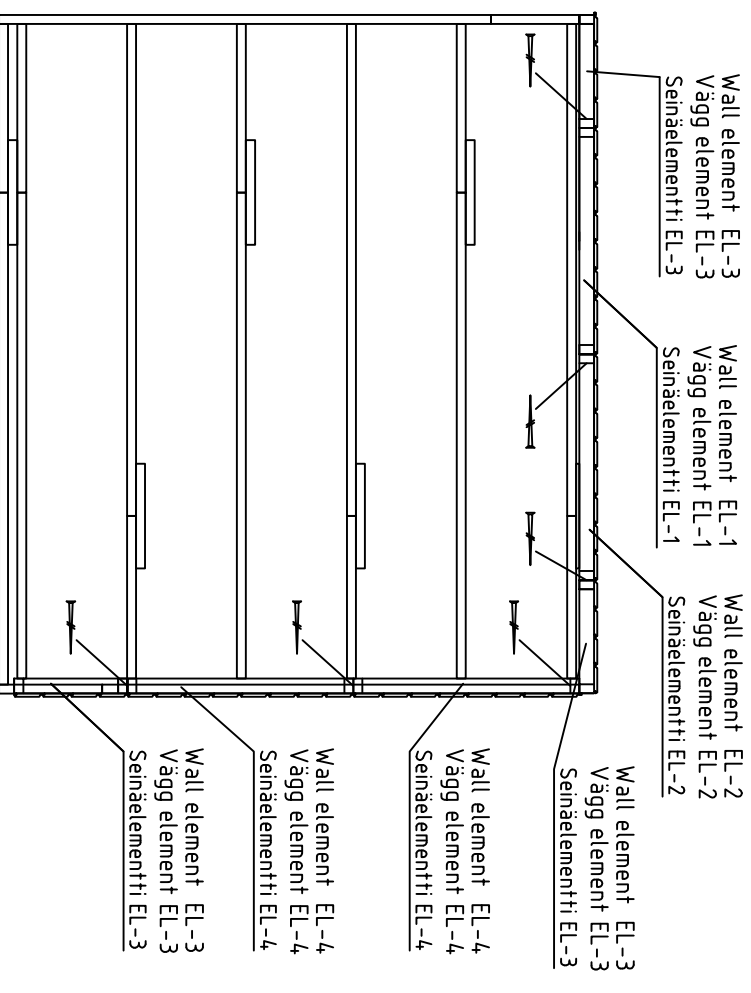

Date rev. Description

House	E3330-16 Björkö	Sheet	9
Drawing		Scale	1:35
Material		Date	15.12.2015
Drawer	K.K.	File	E3330-16 Björkö.dwg

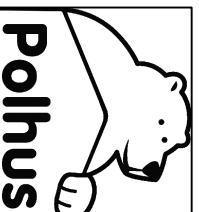

Installation of left sidewall – montering av vänster sidovägg – vasen sivuseinä asennus

View from inside – Från insidan – Näkymä sisältä

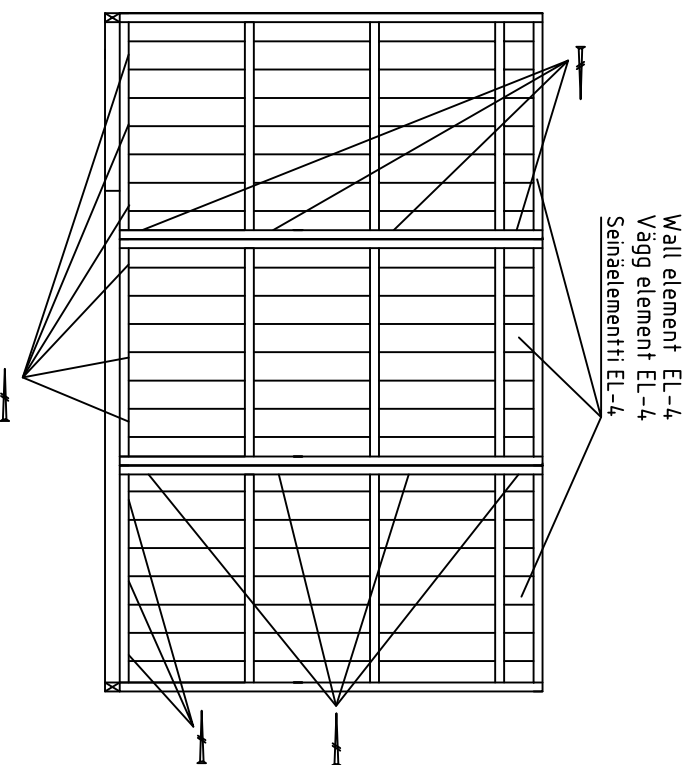

Fix wall element EL-3 and EL-4 (3pcs) with screws

4.5x70 into floorbeam

Fixera vägg element EL-3 and EL-4 (3pcs) med skruvar

4.5x70 i golvbjälke

Kiinnitä seinäelementti EL-3 and EL-4 (3pcs) ruuveilla

4.5x70 lattipalkkin

Fix wall elements EL-3 and EL-4 (3pcs) with screws 4.5x70 together

Fixera vägg element EL-3 and EL-4 (3pcs) med skruvar 4.5x70 tillsammans

Kiinnitä seinäelementit EL-3 and EL-4 (3pcs) yhteen ruuveilla 4.5x70

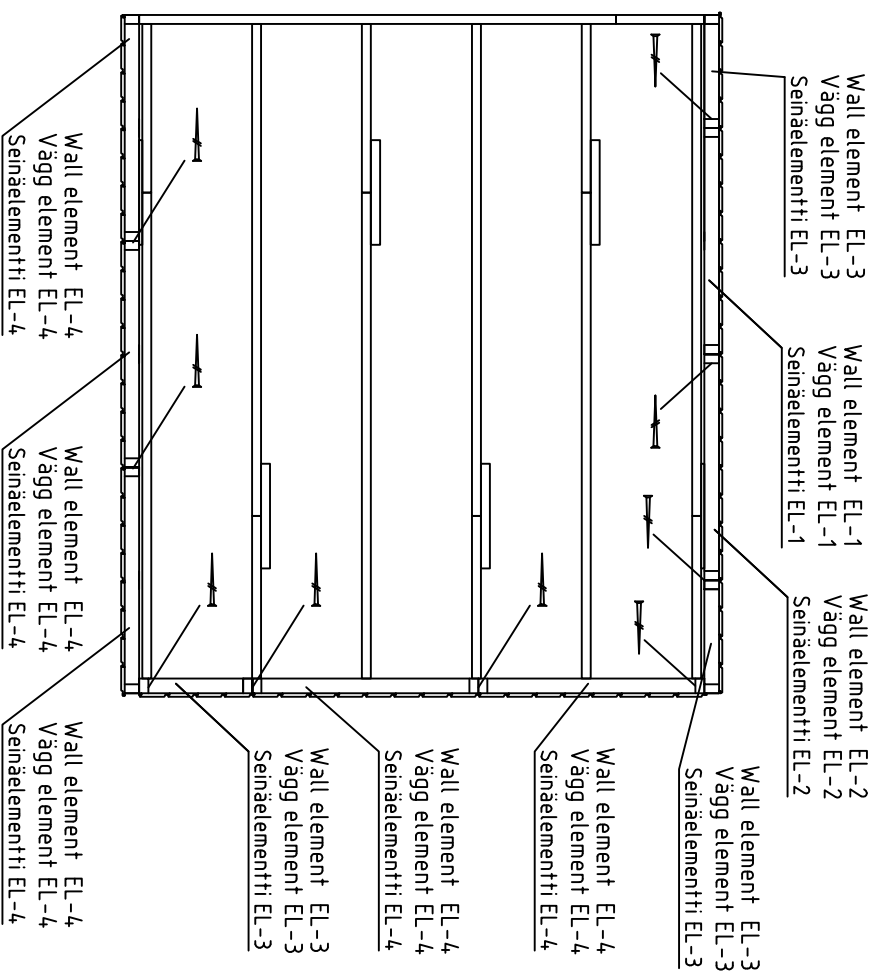

Date rev. Description

House	E3330-16 Björkö	Sheet	10
Drawing		Scale	1:35
Material		Date	15.12.2015
Drawer	K.K.	File	E3330-16 Björkö.dwg

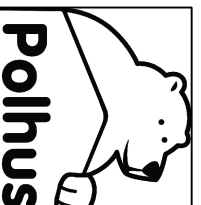

Installation of left sidewall – montering av vänster sidovägg – vasen sivuseinä asennus

View from inside – Från insidan – Näkymä sisältä:

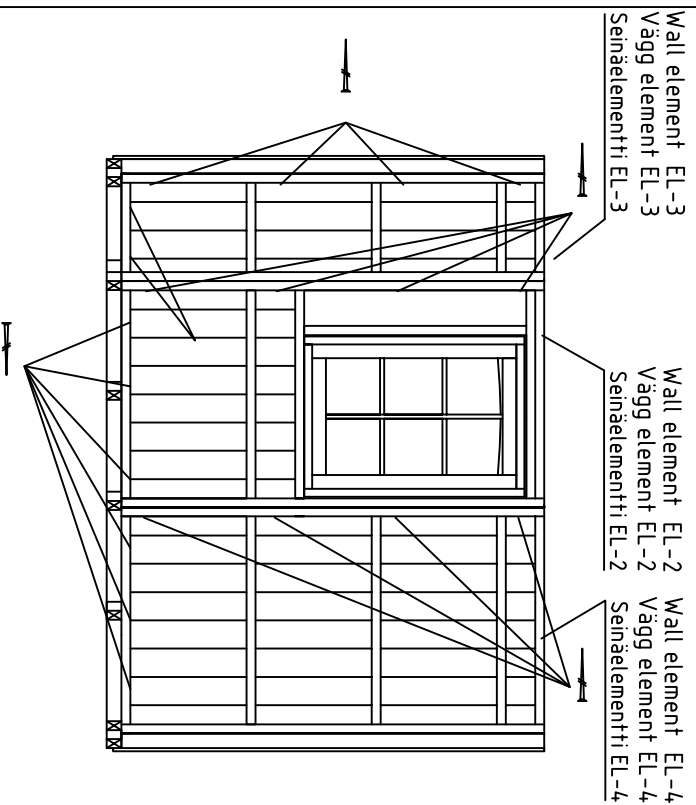

Fix wall element EL-3 and EL-2, EL-4 with screws
 4.5x70 into floorbeam
 Fixera vägg element EL-3 and EL-2, EL-4 med skruvar
 4.5x70 i golvbjälke

Kiinnitä seinäelementti EL-3 and EL-2, EL-4 ruuveilla
 4.5x70 lattitapakkain

Fix wall elements EL-3 and EL-2, EL-4 with screws 4.5x70 together
 Fixera vägg element EL-3 and EL-2, EL-4 med skruvar 4.5x70 tillsammans
 Kiinnitä seinäelementit EL-3 and EL-2, EL-4 yhteen ruuveilla 4.5x70

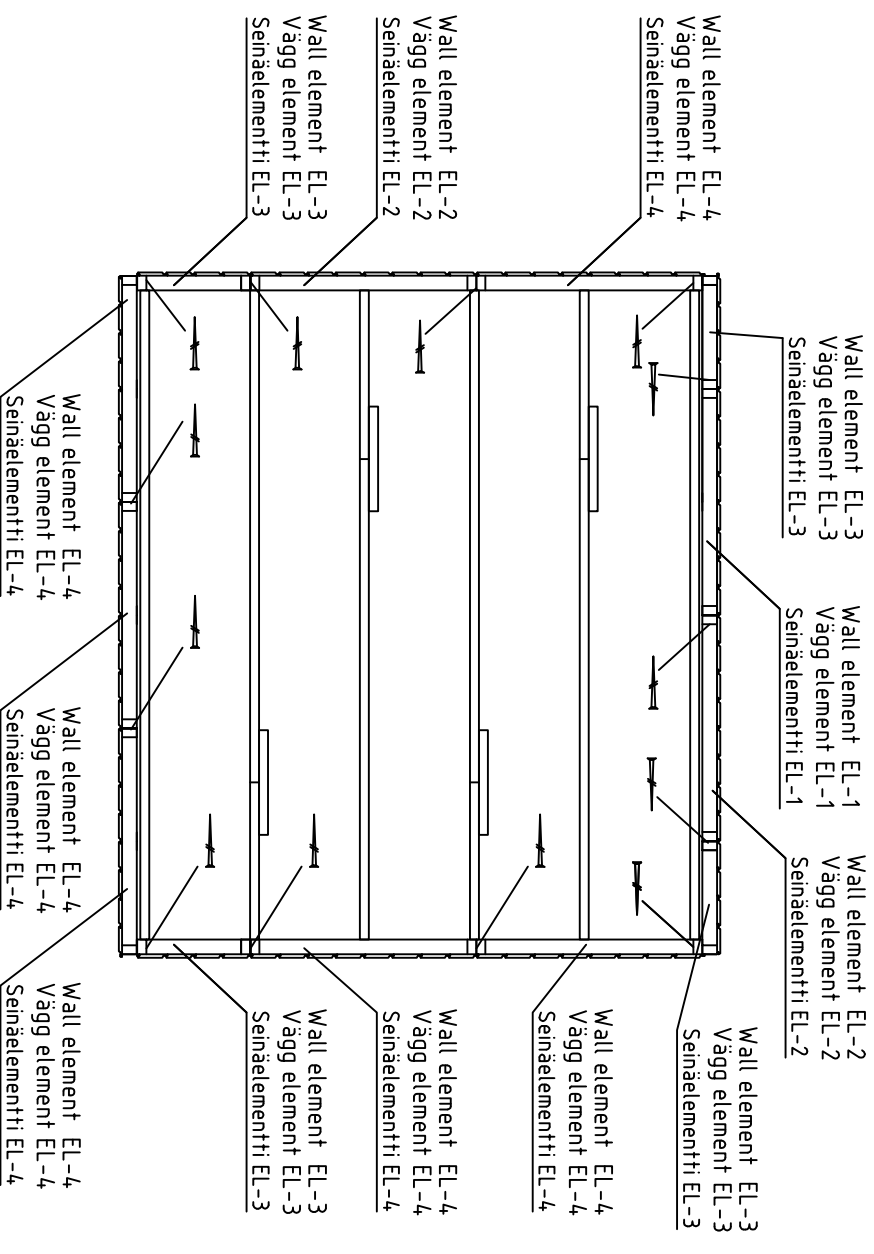

Wall element EL-4
 Vägg element EL-4
 Seinäelementti EL-4

Wall element EL-3
 Vägg element EL-3
 Seinäelementti EL-3

Wall element EL-4
 Vägg element EL-4
 Seinäelementti EL-4

Date rev. Description

House	E3330-16 Björkö	Sheet	11
Drawing		Scale	1:35
Material		Date	15.12.2015
Drawer	K.K.	File	E3330-16 Björkö.dwg

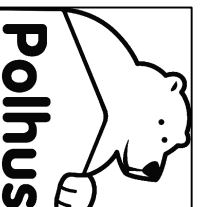

Installation of wall element nr.1/2 and 2/2 – montering av vägg element nr.1/2 och 2/2 – seinäelementin nro.1/2 ja nro.2/2 asennus

View from inside – Från insidan – Nakymä sisästä

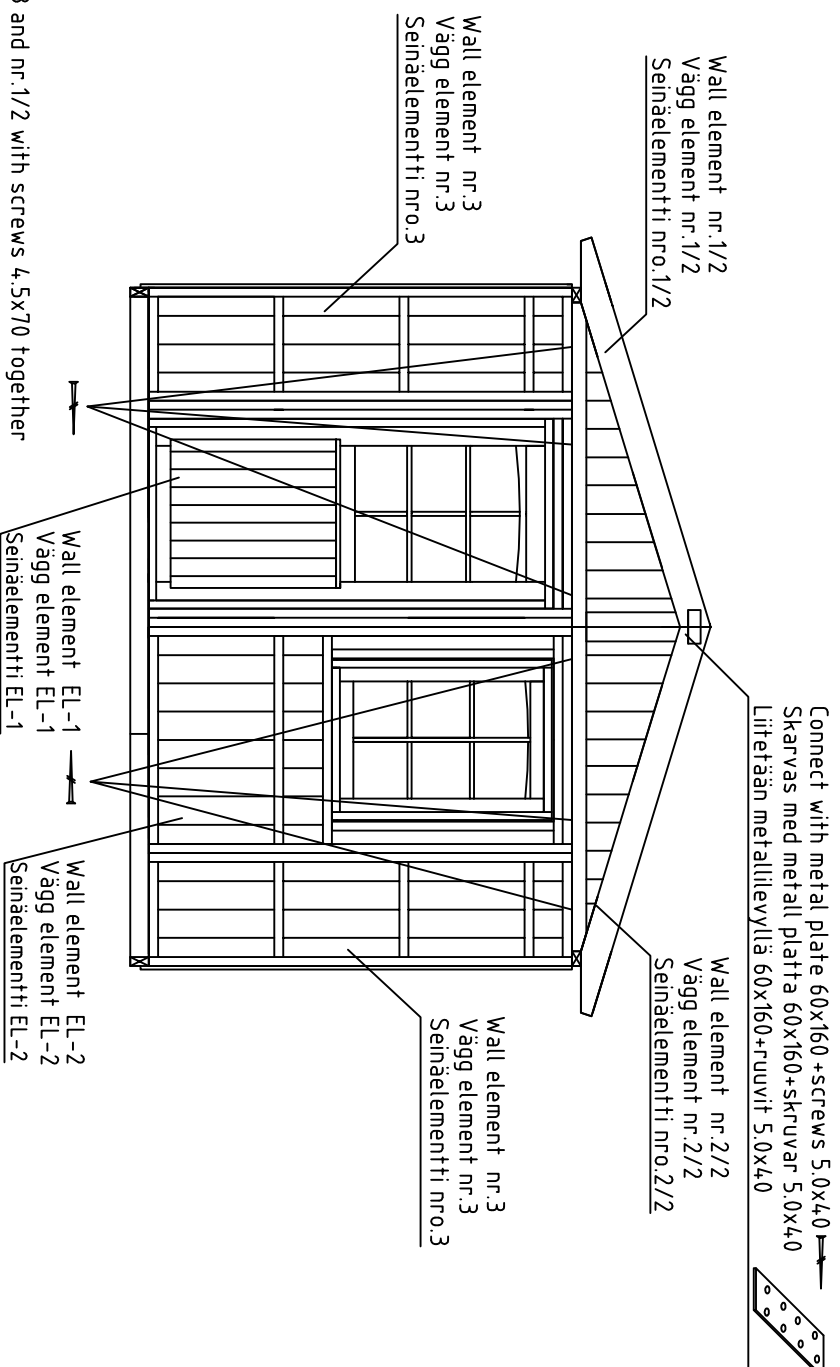

- Fix wall elements nr.1, nr.3 and nr.1/2 with screws 4.5x70 together
 Fixera vägg element nr.1, nr.3 och nr.1/2 med skruvar 4.5x70 tillsammans
 Kiinnitä seinäelementit nro.1, nro.3 ja nro.1/2 yhteen ruuveilla 4.5x70
- Fix wall elements nr.2, nr.3 and nr.2/2 with screws 4.5x70 together
 Fixera vägg element nr.2, nr.3 och nr.2/2 med skruvar 4.5x70 tillsammans
 Kiinnitä seinäelementit nro.2, nro.3 ja nro.2/2 yhteen ruuveilla 4.5x70

Date rev. Description

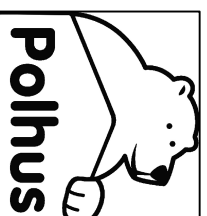

House	E33330-16 Björkö	Sheet	12
Drawing		Scale	1:35
Material		Date	15.12.2015
Drawer	K.K.	File	E33330-16 Björkö.dwg

Installation of wall element nr.5/2 and 6/2 – monteringen av vägg element nr.5/2 och 6/2 –seinäelementin nro.5/2 ja nro.6/2 asennus

View from inside – Från insidan – Nakyma sisältä

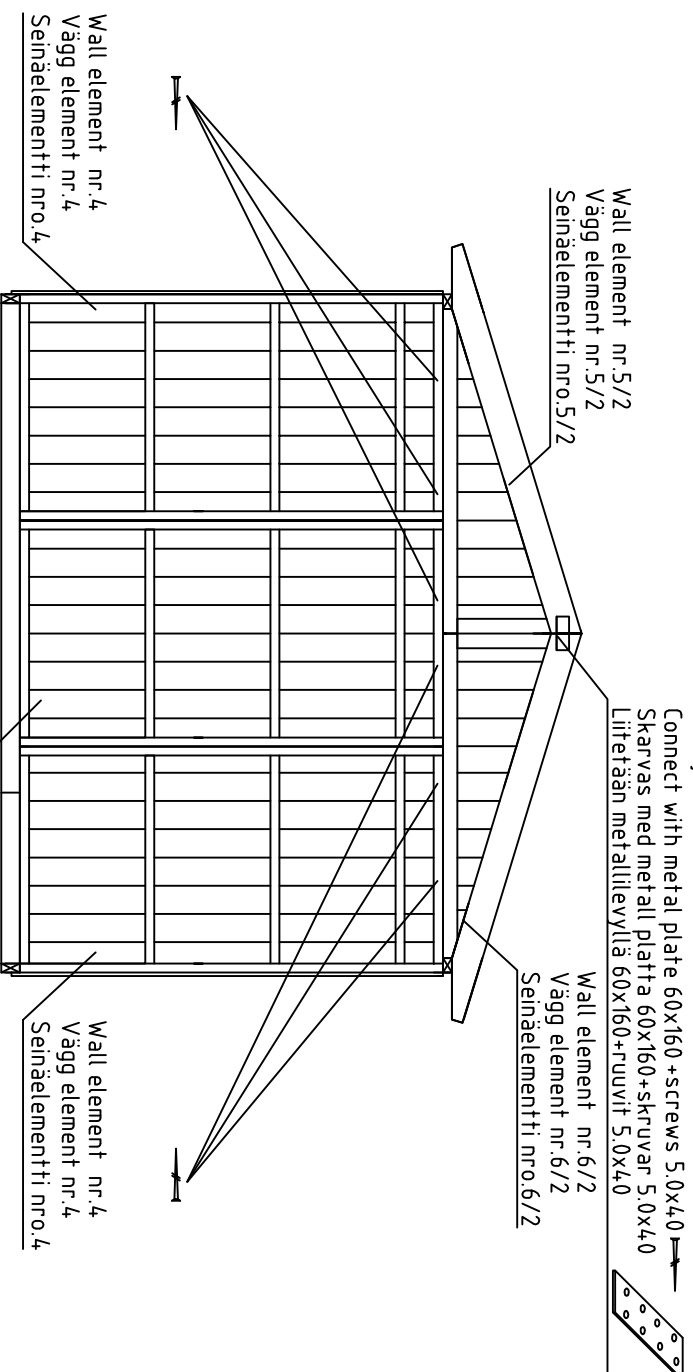

Fix wall elements nr.6(2pcs) and nr.5/2 with screws 4.5x70 together

Fixera vägg element nr.6(2st) och nr.5/2 med skruvar 4.5x70 tillsammans

Kiinnitä seinäelementit nro.6(2kpl) ja nro.5/2 yhteen ruuveilla 4.5x70

wall elements nr.6(2pcs) and nr.6/2 with screws 4.5x70 together

wall vägg element nr.6(2st) och nr.6/2 med skruvar 4.5x70 tillsammans

Kiinnitä seinäelementit nro.6(2kpl) ja nro.6/2 yhteen ruuveilla 4.5x70

Date rev. Description

 Polhus	House	E3330-16 Björkö	Sheet	13
	Drawing		Scale	1:35
	Material		Date	15.12.2015
Drawer	K.K.	File	E3330-16 Björkö.dwg	

Ferms - Takläggning - Kattoparrut

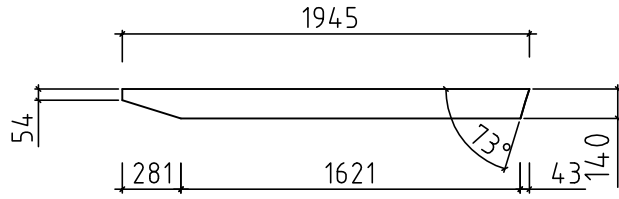

43x140x1945 4pcs-st-kpl

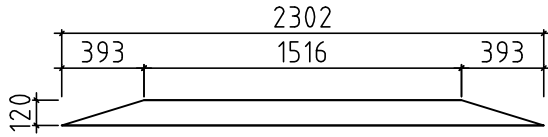

28x120x2302 4pcs-st-kpl

Ferms 2pcs
Takläggning 2st
Kattoparrut 2kpl

Connect with metal plate 60x160
+screws 5.0x40 12pcs

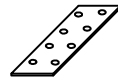

on both sides of the ferm
Skarvas med metall platta 60x160+skruvar 5.0x40
båda sidor takläggning
Liitetään metallilevyllä 60x160+ruuvit 5.0x40
molemmin puolin kattoparru

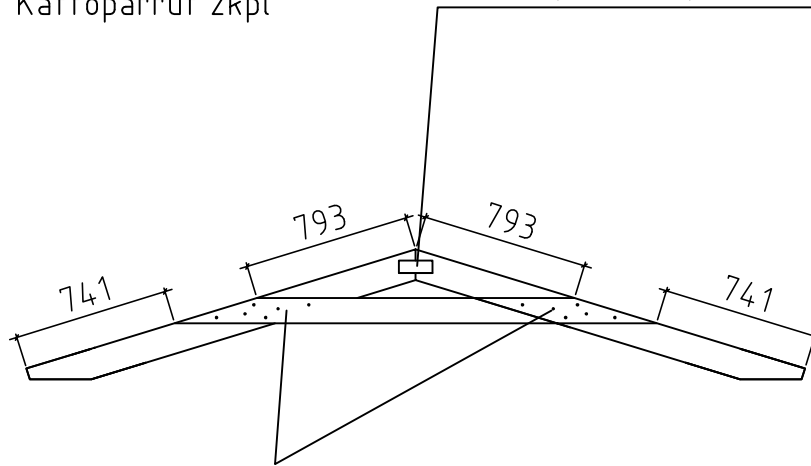

Connect with nails 4x100 (6+6)
on both sides of the ferm

Skarvas med spikar 4x100 (6+6)
båda sidor takläggning

Liitetään nautalla 4x100 (6+6)
molemmin puolin kattoparru

Date rev. Description

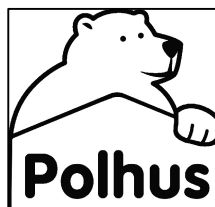

House	E3330-16 Björkö	Sheet	14
Drawing	Ferms-Takläggning-Kattoparrut	Scale	1:35
Material		Date	15.12.2015
Drawer	K.K.	File	E3330-16 Björkö.dwg

Ferm install-installeria takläggning-kattoparru asennus

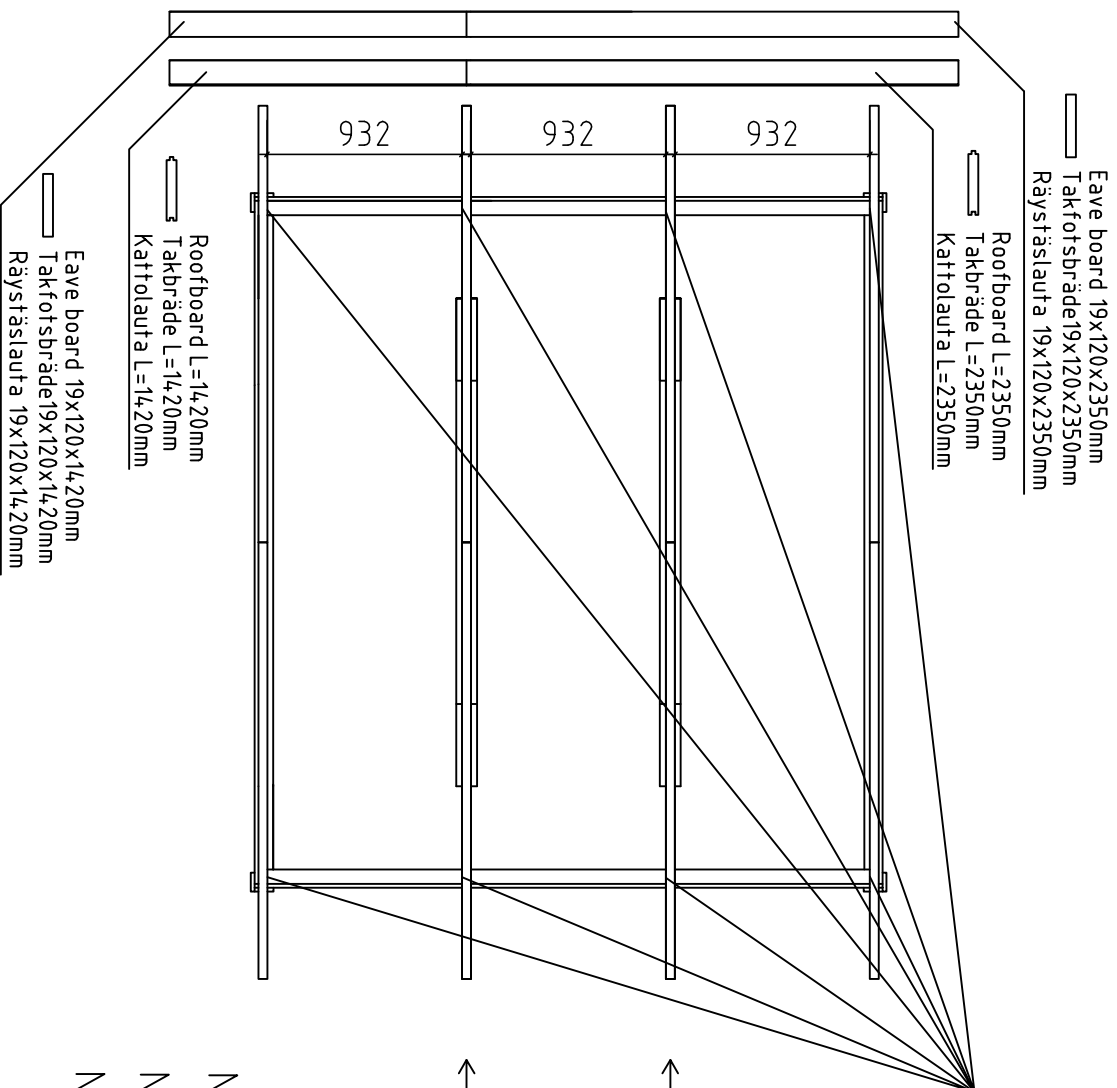

Connect with steel corner 90x90x65+screws 4.5x4.5 8pcs
 Skarvas med metallvinkel 90x90x65+skruvar 4.5x4.5 8st
 Liitetään kulmarautaan 90x90x65+ruuvit 4.5x4.5 8kpl



Back ferm
 Bakre takläggning
 Takapuolinen kattoparru

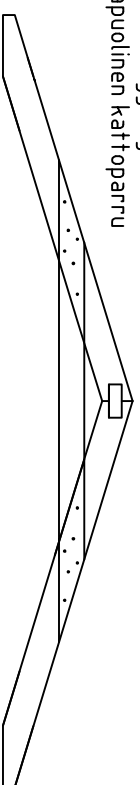

Front ferm
 Först takläggning
 Etupuolinen kattoparru

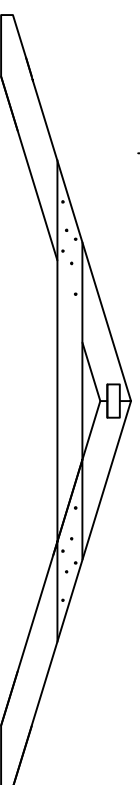

NB!!! max load on the roof 100kg/m²

NB!!! max belastning på taket 100kg/m²

NB!!! suurin sallittu kokonaispaino katolla 100kg/m²

Date rev. Description

House	E3330-16 Björkö
Drawing	Ferm install-installeria takläggning
Material	
Drawer	K.Kahu
File	E3330-16 Björkö.dwg
Sheet	15
Scale	1:35
Date	15.12.2015

2 PAKKI L<2.35m

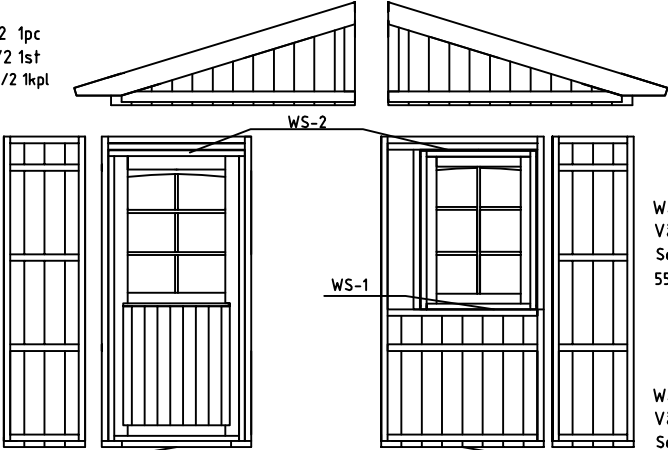
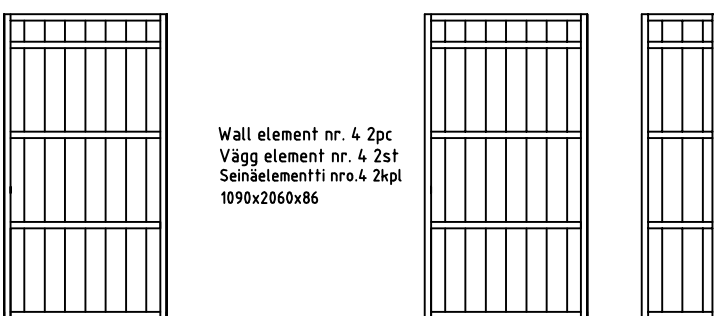
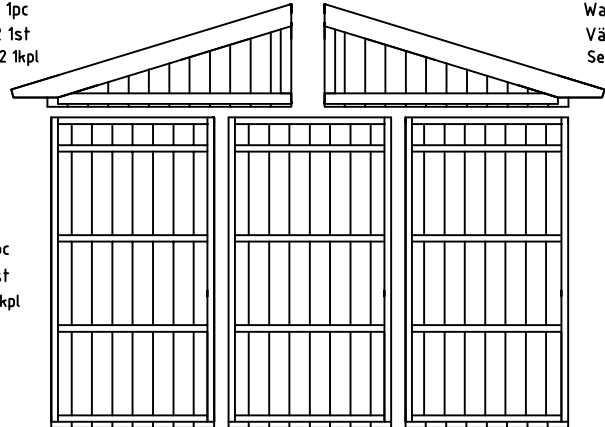
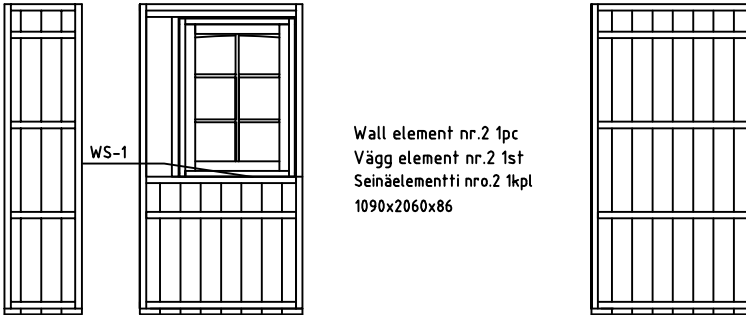
Pos	E3330-16 Björkö	Nr. Pcs.	Profile (mm)	L (mm)
	<p>Wall element nr.1/2 1pc Vägg element nr.1/2 1st Seinäelementti nro.1/2 1kpl 1860x683x86</p>  <p>Wall element nr.2/2 1pc Vägg element nr.2/2 1st Seinäelementti nro.2/2 1kpl 1860x683x86</p> <p>Wall element nr.3 2pc Vägg element nr.3 2st Seinäelementti nro.3 2kpl 550x2060x86</p> <p>Wall element nr.1 1pc Vägg element nr.1 1st Seinäelementti nro.1 1kpl 1090x2060x86</p> <p>Wall element nr.2 1pc Vägg element nr.2 1st Seinäelementti nro.2 1kpl 1090x2060x86</p>			
	 <p>Wall element nr. 4 2pc Vägg element nr. 4 2st Seinäelementti nro.4 2kpl 1090x2060x86</p> <p>Wall element nr. 3 1pc Vägg element nr. 3 1st Seinäelementti nro.3 1kpl 550x2060x86</p>			
	<p>Wall element nr.5/2 1pc Vägg element nr.5/2 1st Seinäelementti nro.5/2 1kpl 1860x683x86</p>  <p>Wall element nr.6/2 1pc Vägg element nr.6/2 1st Seinäelementti nro.6/2 1kpl 1860x683x86</p> <p>Wall element nr.4 3pc Vägg element nr.4 3st Seinäelementti nro.4 3kpl 1090x2060x86</p>			
	 <p>Wall element nr.3 1pc Vägg element nr.3 1st Seinäelementti nro.3 1kpl 550x2060x86</p> <p>Wall element nr.2 1pc Vägg element nr.2 1st Seinäelementti nro.2 1kpl 1090x2060x86</p> <p>Wall element nr.4 1pc Vägg element nr.4 1st Seinäelementti nro.4 1kpl 1090x2060x86</p>			

DOOR HANDLE - OVEN KAHVA - DÖRR HANDTAG		1		
DOOR LOCK+KEYS - OVENLUKKO+AVAIN - DÖRRLAS+NYCKLAR		1		
WINDOW HANDLE - IKKUNA KAHVA - FÖNSTER HANDTAG		2		
DOORCROSSES - OVENRISTIKKO - SPRÖJS		1		













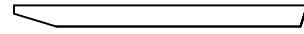
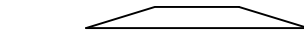
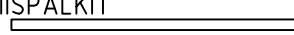
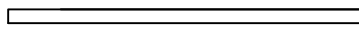
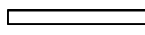

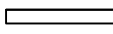
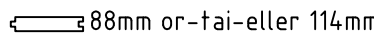
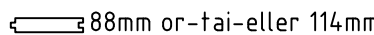
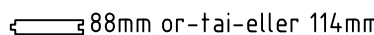
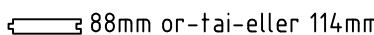
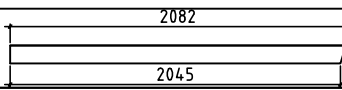





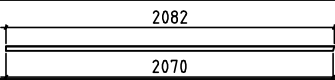

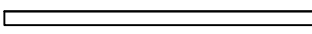
Kood E3330-16 Björkö

Materjal

File E3330-16 Björkö.dwg

Leht 16

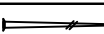
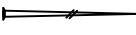
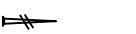
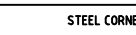
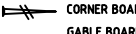
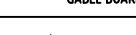
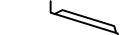
2 PAKKI L<2.35m

Pos	E3330-16 Björkö	Nr. Pcs.	Profile (mm)	L (mm)
	WINDOW CROSSES - IKKUNARISTIKKO - SPRÖJS 	2		
	ROOFBEAM - KATTOPALKI - TAKBJÄLKAR 	4	43x140	1945
	ROOFBEAM - KATTOPALKI - TAKBJÄLKAR 	4	28x120	2302
SCB	SIDEWALL CONNECTING BEAM - SIVUSEINÄ YHDISTAMISPALKIT 	4	43x70	1421
	BJÄLKAR FÖR SIDOVÄGG SAMMANSLAGNING			
FB1	FLOORBEAM - LATTIAPALKI - GOLVBJÄLKAR 	10	45x90	2350
FB2	FLOORBEAM - LATTIAPALKI - GOLVBJÄLKAR 	8	45x90	805
FB3	FLOORBEAM - LATTIAPALKI - GOLVBJÄLKAR 	2	45x90	492
FB4	FLOORBEAM - LATTIAPALKI - GOLVBJÄLKAR 	6	45x90	500
	FLOORBOARD - LATTIALAUTA - GOLVBRÄDE  88mm or -tai- eller 114mm	28+1 36+1	19x114 19x88	1615
	FLOORBOARD - LATTIALAUTA - GOLVBRÄDE  88mm or -tai- eller 114mm	28+1 36+1	19x114 19x88	1085
	ROOFBOARD - KATTOLAUTA - TAKBRÄDE  88mm or -tai- eller 114mm	40 50	19x114 19x88	2350 2350
	ROOFBOARD - KATTOLAUTA - TAKBRÄDE  88mm or -tai- eller 114mm	40 50	19x114 19x88	1420 1420
GB	GABLE BOARD - KAAPELILAUTA - GAVELBRÄDA 	4	19x120	2082
EB1	EAVE BOARD - RÄYSTÄSLAUTA - TAKFOTSBRÄDE 	4	19x120	2350
EB2	EAVE BOARD - RÄYSTÄSLAUTA - TAKFOTSBRÄDE 	4	19x120	1906
EB3	EAVE BOARD - RÄYSTÄSLAUTA - TAKFOTSBRÄDE 	2	19x90	2350
EB4	EAVE BOARD - RÄYSTÄSLAUTA - TAKFOTSBRÄDE 	2	19x90	1906
RFF	ROOF FELT FILLET - KATON PÄÄTYLAUTA - BRÄDE OVANPÅ GAVELBRÄDE 	4	19x35	2180
GS	GABLE SLAT - KAAPELILISTA - VINDLIST 	4	30x40	2082
	FLOOR SKIRTING - LATTIALISTA - GOLVLIST 	6	19x35	2000
	CORNER BOARD - KULMANLAUTA - HÖRNBRÄDE 	8	19x90	2060
	FILLING BOARD- TÄYTTÖLAUTA- FYLLNADSBRÄDE 	2	16x75	2060
	FILLING BOARD- TÄYTTÖLAUTA- FYLLNADSBRÄDE 	2	16x80	2060
	STEEL CORNER - KULMARAUTA - VINKELJÄRN 	8	90x90	65
	STEEL PLATE - METALLILEVY - METALLPLATTA 	8 8	2,5x80 2,5x60	200 160
	NAILS - NAULAT - SPIKAR  ROOFBEAM - KATTOPALKI - TAKBJÄLKAR	30	4x100	
	NAILS - NAULAT - SPIKAR  FLOORBOARD - LATTIALAUTA - GOLVBRÄDE	520	2,5x60	
	NAILS - NAULAT - SPIKAR  ROOFBOARD - KATTOLAUTAT - TAKBRÄDE	30	2,0x40	
	NAILS - NAULAT - SPIKAR  SKIRTING SLAT - LATTIALISTA - GOLVLIST			
	SCREW - RUUVIT - SKRUVAR  FLOORBEAMS - LATTIAPALKIT - GOLVBJÄLKAR	125	4,5x70	
	SCREW - RUUVIT - SKRUVAR  ELEMENT CONNECTING - ELEMENTTI YHDISTAMIS - ELEMENT SAMMANSLAGNING	200	5,0x40	
	SCREW - RUUVIT - SKRUVAR  STEEL PLATE - METALLILEVY - METALLPLATTA			
	SCREW - RUUVIT - SKRUVAR  STEEL CORNER - KULMARAUTA - VINKELJÄRN EAVE BOARD - RÄYSTÄSLAUTA - TAKFOTSBRÄDE	180	4,5x45	
	SCREW - RUUVIT - SKRUVAR  CORNER BOARD - KULMANLAUTA - HÖRNBRÄDE WATER SLAT - VEDELISTA - VATTENLIST			
	SCREW - RUUVIT - SKRUVAR  GABLE BOARD - KAAPELILAUTA - VINDBRÄDE GABLE SLAT - KAAPELILISTA - VINDLIST			
WS-1	WINDOW WATER SILL 	2		
WS-2	WATER SILL 	2		



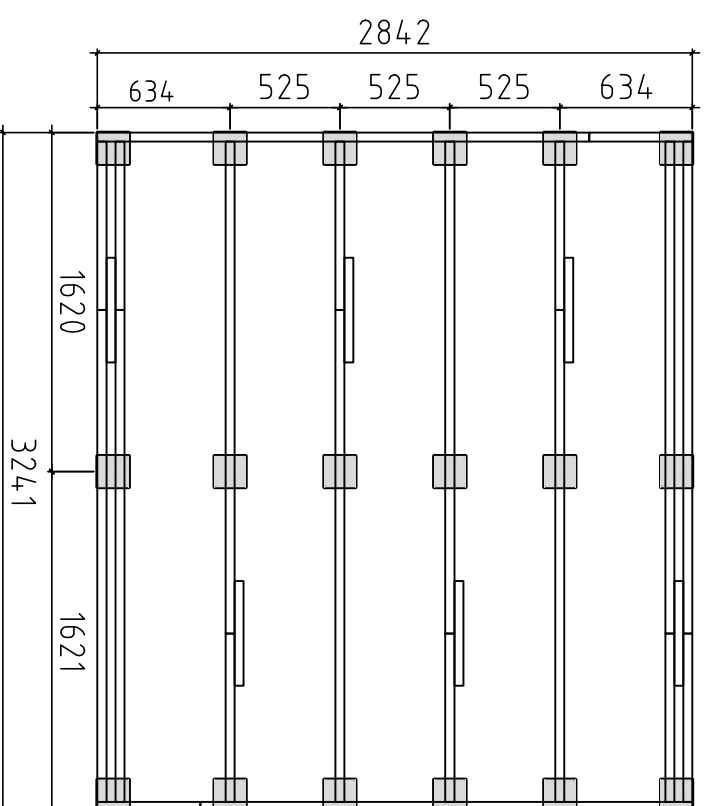

A proposal for placing plinths (100-200 mm in diameter) for floor beams. Floor beams are provided in the kit but plinths are not included. For example, by using 500-600 mm long masonry units, one can reduce the number of points 50%.

Tämä on ehdotus siitä, miten (100-200 mm läpimittaiset) jalat voidaan sijoittaa alapohjaa varten. Lattiapalkit ovat rakennussarjassa, mutta jalkoja ei ole. Kun käytetään esimerkiksi 500-600 mm pitkiä harkkoja, voidaan pisteiden määrä puolittaa.

Detta är ett förslag för hur man kan placera plintarna (100- 200 mm i diameter) för golvbjälklaget. Golvbjälkarna är med i byggsatsen, men inte plintarna. Använder man exempelvis 500-600mm långa murblock så kan man halvera antalet punkter.

Date rev. Description

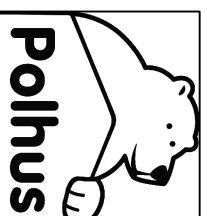

House	E3330-16 Björkö	Sheet	18
Drawing	FOUNDATION PLAN - PLINTPLAN	Scale	1:35
Material		Date	07.01.2015
Drawer	K.K	File	E3330-16 Björkö.dwg