

Pembrokeshire 53
Art. Nr. 4414740
1/11



30.11.2017

Art.Nr. 4414740

1:100

FASADER OCH GRUNDPLAN - VISNINGER OG GRUNNPLAN -
TEGNINGER OG GRUNDPLAN - JULKISIVUT JA POHJAPIIRUSTUS

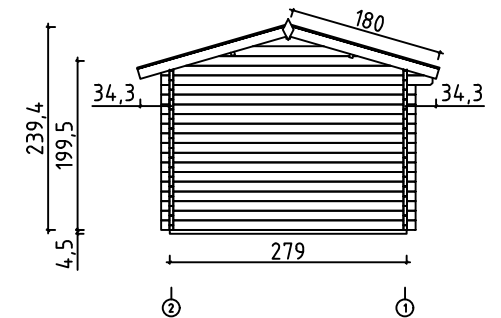
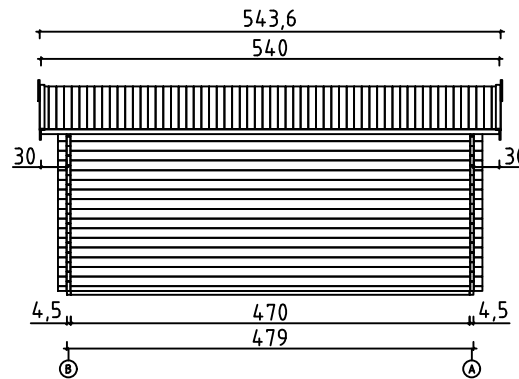
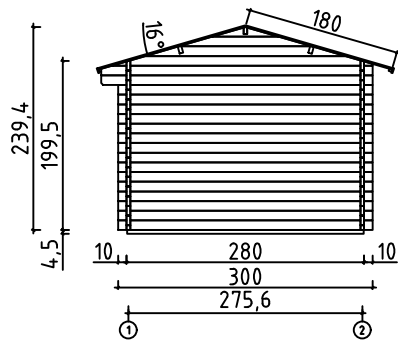
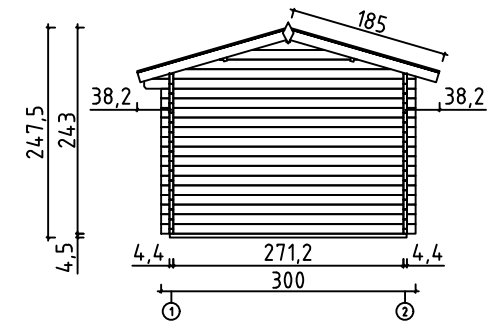
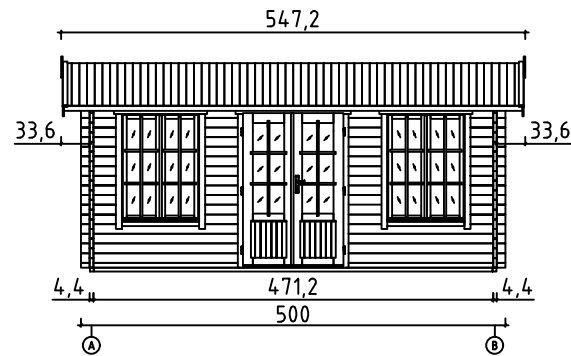
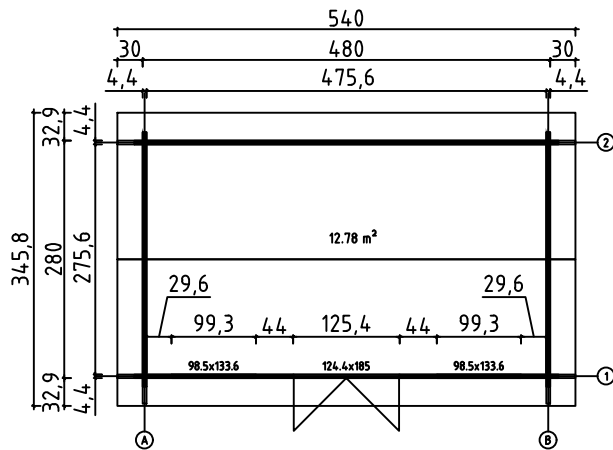

Art.Nr. 4414740

PLANRITNING - GRUNNPLAN - GRUNDPLAN - POHJAPIIRUSTUS

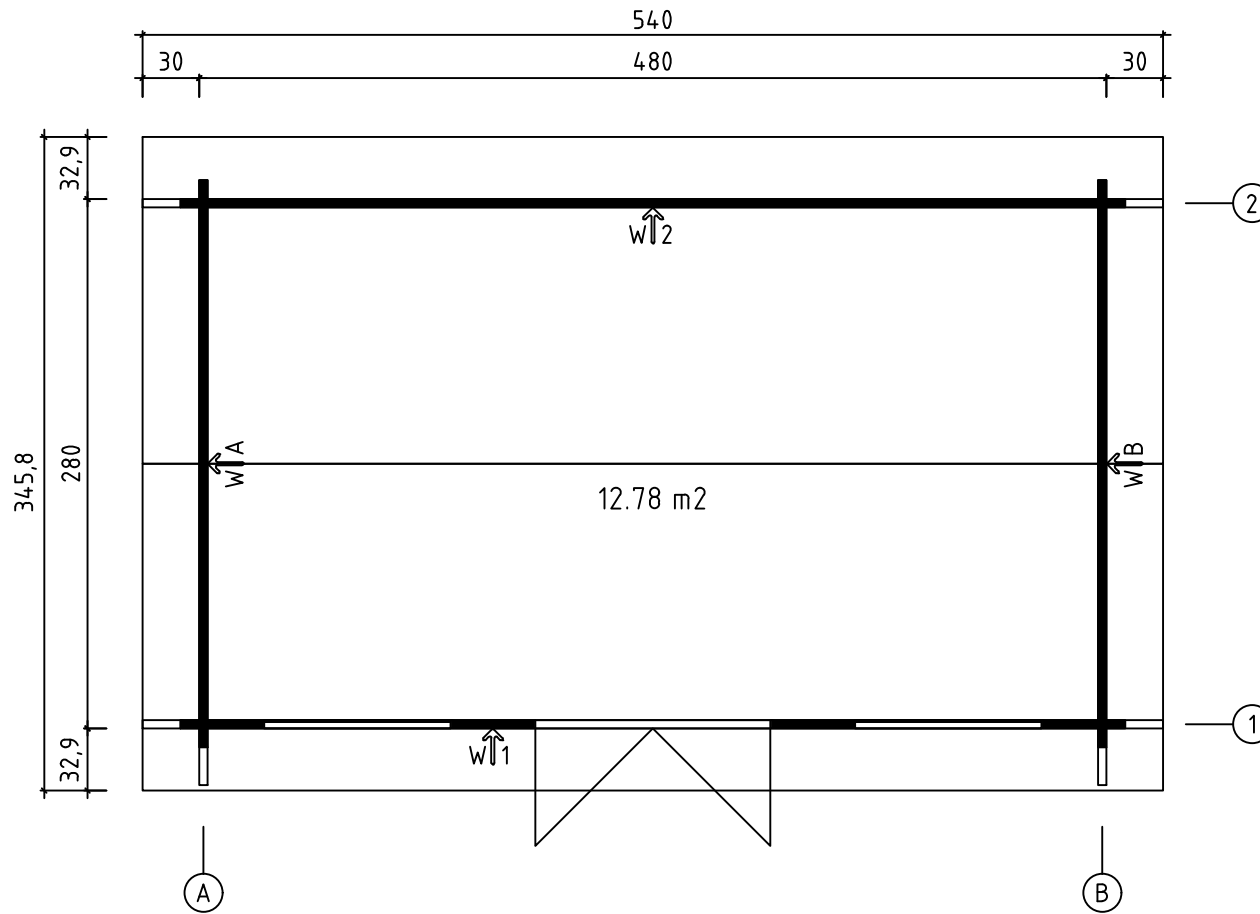







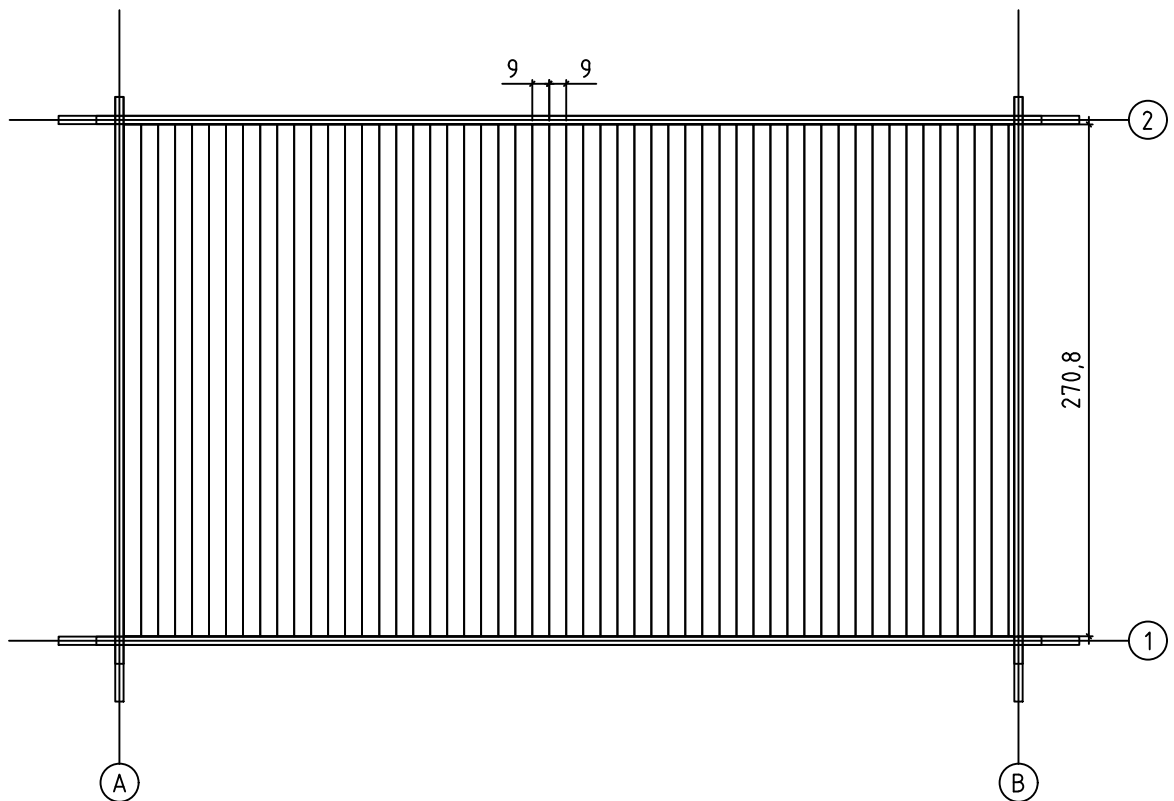

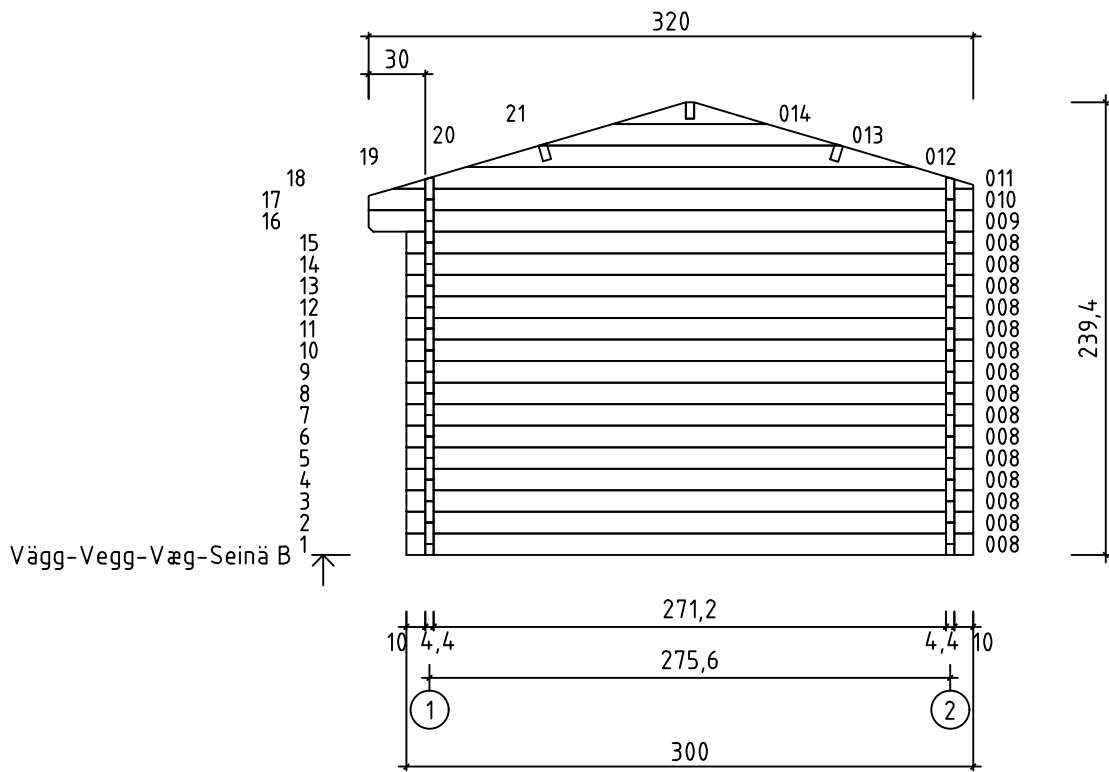
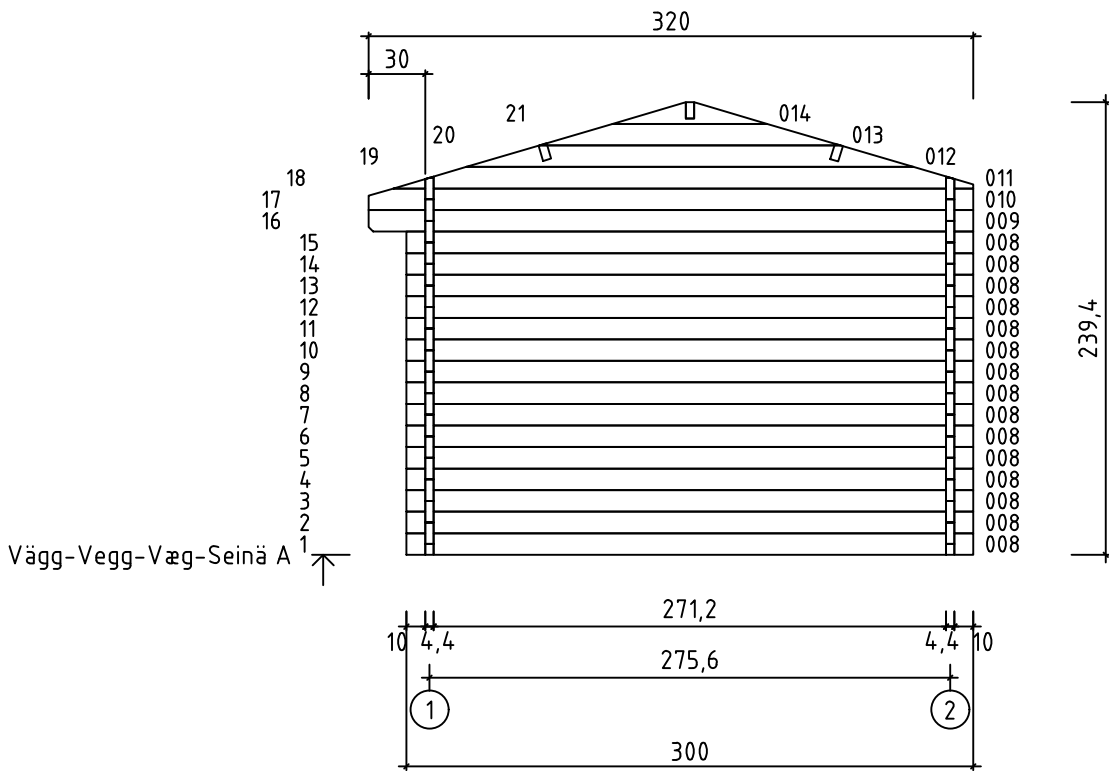

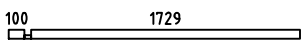
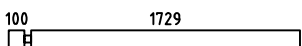
GRUND - GRUNNMUR - FUNDAMENT - PERUSTUS

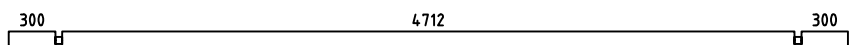
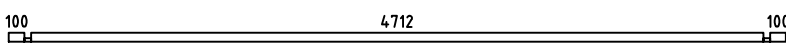
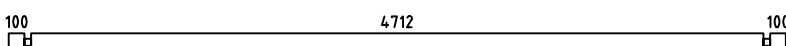
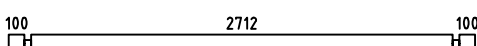
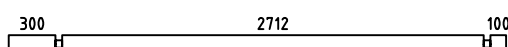
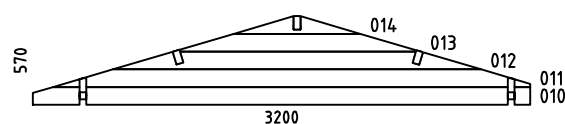
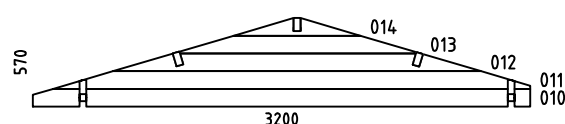
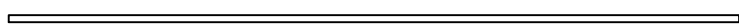

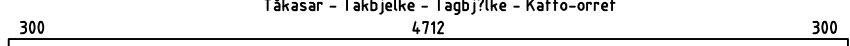



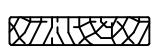

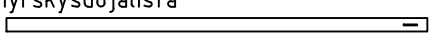

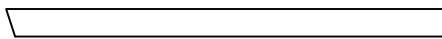
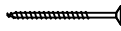
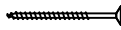
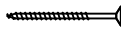
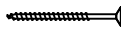
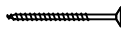
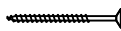
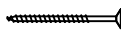



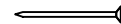
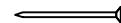

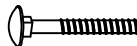
GOLVBRÄDOR - GULVBORD - GULVBRÆDDER - LATTIALAUDAT



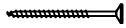
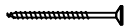
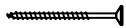
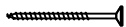

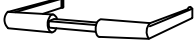
Pos	29.11.2017 Delförteckning - Liste over deler - Stykliste - Osaluettelo Art.Nr. 4414740	7/11	Q	P (mm)	L (mm)
001			2	44x57	1873
002			8	44x114	1873
003			24	44x114	440
004			24	44x114	440
005			2	44x120	5400
006			1	44x57	5000
007			16	44x114	5000
008			30	44x114	3000
009			2	44x114	3200
WA-1			1		
WB-1			1		
IAR2	Grund - Grunnmur - Fundament - Perustus 		8	45x45	4700
IAR1	Grund - Grunnmur - Fundament - Perustus 		2	45x45	2790
A-PR1	Täkasar - Takbjelke - Tagbjelke - Katto-orret 		3	44x140	5400
	Golvbrädor - Gulvbord - Gulvbrødder - Lattialaudat 		53	90x18	2708
	Takbräde - Takbord - Tagbrødder - Kattolauta 		120	90x18	1800
	Golvläkt - Gulvlist - Gulvliste - Jalkalista 			18x18	14.83
	Takläkt - List for takpapp - Tagpapliste - Kattohuopalista 		4	18x58	1850
TB-1	Takfotsinklädning - Speilbord - Sternbrøft - Ræystäslauta 		4	18x58	2700
DRV-1	Takfot - Forsterkning av takforkant - Tagkantsforsterkning - Ræystäslista 		4	28x34	2700
KFS-1	Storm säkring - Vindavstivningslist - Stormliste - Myrskysuojalista 		4	22x45	2050

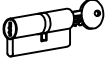
Pos	29.11.2017 Delförteckning - Liste over deler - Styklister - Osaluettelo Art.Nr. 4414740	8/11	Q	P (mm)	L (mm)
	Vindbräde - Vindski - Vindskede - Kaapelilauta 		4	18x120	1850
HS8	Skruv för gavelsegment - Skrue for gavledel - Skrue til gavlsegment - Koristepalan ruuvi 		4	3.5x35	
HS9	Skruv för gavelläkt - Skrue for vindski - Skrue til vindskede - Harjalistan ruuvi 		24	3.5x50	
HS12	Skruv för takfotsinklädning - Skrue for speilbord - Skrue til sternbrødder - Rästälslaudan ruuvi 		24	4x40	
HS12	Skruv för förstärkningsreglar till takfot - Skrue for forsterkning av takforkant - Skrue til tagkantsforsterkning - Katon reunan vahvistusruuvi 		24	4x40	
HS18	Skruv för takbjälkar - Skrue for takbjelker - Skrue til tagbjælker - Kattopalkin ruuvi 		10	5x120	
HS16	Skruv för 1. väggregel - Skrue for første stokklag - Skrue til første væggbjælke - 1. seinäpalkin ruuvi 		8	5x90	
HS16	Skruv för grund - Skrue for grunnmur - Skrue til fundament - Perustuksen ruuvi 		8	5x90	
NF2	Zn spik för golvläkt - Sinkstift for gulvlist - Zn søm til gulvliste - Sinkitty naula jalkalistan asennukseen 		30	1.4x40	
SH44	Hammarkloss - Hoggestabbe - Trækloids til hamring - Naulauskappale 		1		
SFS	Mutter för strömsäkring - Mutter for vindavstivningslist - Møtrik til stormliste - Myrskysuojalistan mutteri 		8	D8	
NF4	Förzinkad takspik - Sinkspiker for tak - Zn søm til tag - Sinkitty kattonaula 		374	2x50	
NF4	Förzinkad golvspik - Sinkspiker for gulv - Zn søm til loft - Sinkitty lattianaula 		324	2x50	
NF5	Förzinkad spik för takläkt - Sinkspiker for takpappliste - Zn søm til tagpapliste - Kattohuopalistin sinkitty naula 		20	2x40	
BFS	Bult för strömsäkring - Bolt for vindavstivningslist - Bolt til stormliste - Myrskysuojalistan pultti 		8	8x80	
GS	Gavelsegment - Gavledel - Gavlsegment - Koristepala 		2		
DFS	Bricka för strömsäkring - Skive for vindavstivningslist - Skive til stormliste - Myrskysuojalistan aluslaatta 		8	D8	
	Fönster - Vindu - Vindue - Ikkuna 985x1336 TAK.1.106.TPSV.f DGP+		1		
	Fönster - Vindu - Vindue - Ikkuna 985x1336 TAK.1.106.TPSP.f DGP+		1		
	Dörr - Dør - Dør - Ovi 1244x1850 TUK.2.066.TPVP.MMWe DGP+		1		

Pos	29.11.2017 Delförteckning - Liste over deler - Stykliste - Osaluettelo 1244x1850 TUK.2.066.TPVP.MMWe DGP+	9/11	Q	P (mm)	L (mm)
HS1	Skruv för spröjs - Skrue for sprosser - Skrue til sprosser - Jakopuitteen ruuvi		12	2.5x20	
HS4	Skruv för golvläkt - Skrue for dørlist - Skrue til dørliste - Ovilistan asennusruuvi		5	3x30	
HS16	Skruv för dörrkarm - Skrue for dørstolpe - Skrue til dørkarm - Oven karmin ruuvi		4	5x90	
HS25	Skruv för dörrtröskel - Skrue for terskel - Skrue til dørtrin - Kynnyksen ruuvi		3	4.5x65	
MH	Gångjärn för dörr - Bolt for dørhengsel - Hanskrue til dørhengsel - Oven sarana		6	14x80	
HC	Gångjärnsskåpor för dörr - Deksel over hengsle - Høngsel-døksel - Oven sarana suoja		12		
TL4	Handtag för dörr - Dørbeslag - Dørhåndtag - Ovenpainike		1		
TL5	Sats med täckbrickor för dörrlås - Et sett av dørbeslag - Sæt af låsedøksler - Lukkokilpisarja		1		
	Cylinder - Sylindertås - Cylinderlås - Sylinterilukko		1	30x35	
	Låsets slutstycke - Fallelåsens sluttstykke - Låsens slutstykke - Ovensalvan vastakappale		2		

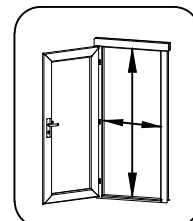
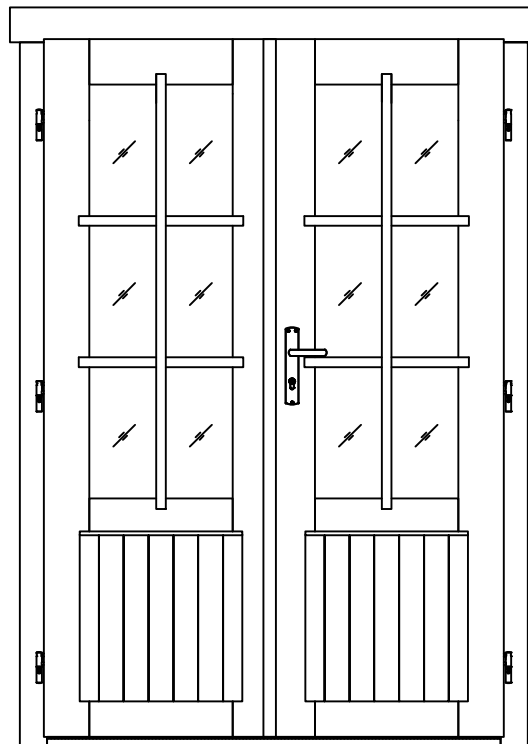

1144x1766 mm

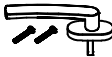
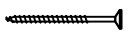
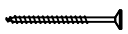
Pos	29.11.2017 Delförteckning - Liste over deler - Stykliste - Osaluettelo 985x1336 TAK.1.106.TPSP.f DGP+	10/11	Q	P (mm)	L (mm)
FS2	Handtagsbeslag för fönster - Vridere til vinduer - Vindueshåndtag - Ikkunanpainikkeet		1		
HS1	Skruv för spröjs - Skrue for sprosser - Skrue til sprosser - Jakopuitteen ruuvi		12	2.5x20	
HS4	Skruv för fönsterläkt - Skrue for vinduslist - Skrue til vinduesliste - Ikkunalistan asennusruuvi		3	3x30	

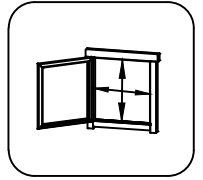
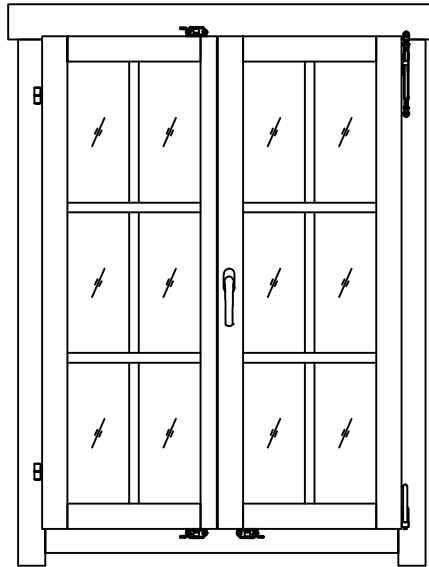

885x1240 mm

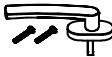
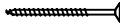
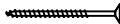
Pos	29.11.2017 Delförteckning - Liste over deler - Stykliste - Osaluettelo 985x1336 TAK.1.106.TPSV.f DGP+	11/11	Q	P (mm)	L (mm)
FS2	Handtagsbeslag för fönster - Vridere til vinduer - Vindueshåndtag - Ikkunanpainikkeet		1		
HS1	Skruv för spröjs - Skruer for sprosser - Skruer til sprosser - Jakopuitteen ruuvi		12	2.5x20	
HS4	Skruv för fönsterläkt - Skruer for vinduslist - Skruer til vinduesliste - Ikkunalistan asennusruuvi		3	3x30	

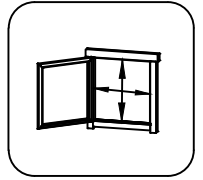
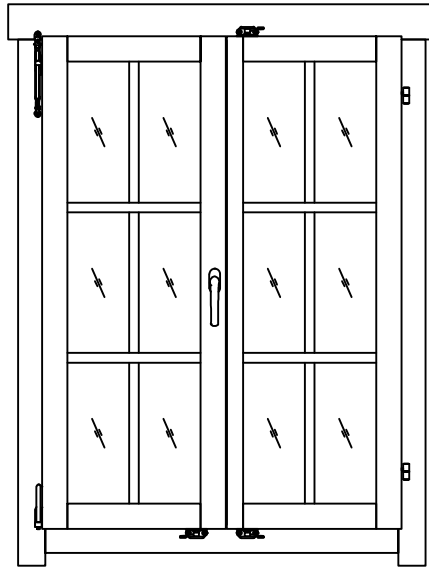

885x1240 mm