

Montrose 44
Art. Nr. 4419902
1/12



30.05.2018

Art.Nr. 4419902

1:100

FASADER OCH GRUNDPLAN - VISNINGER OG GRUNNPLAN -
TEGNINGER OG GRUNDPLAN - JULKISIVUT JA POHJAPIIRUSTUS

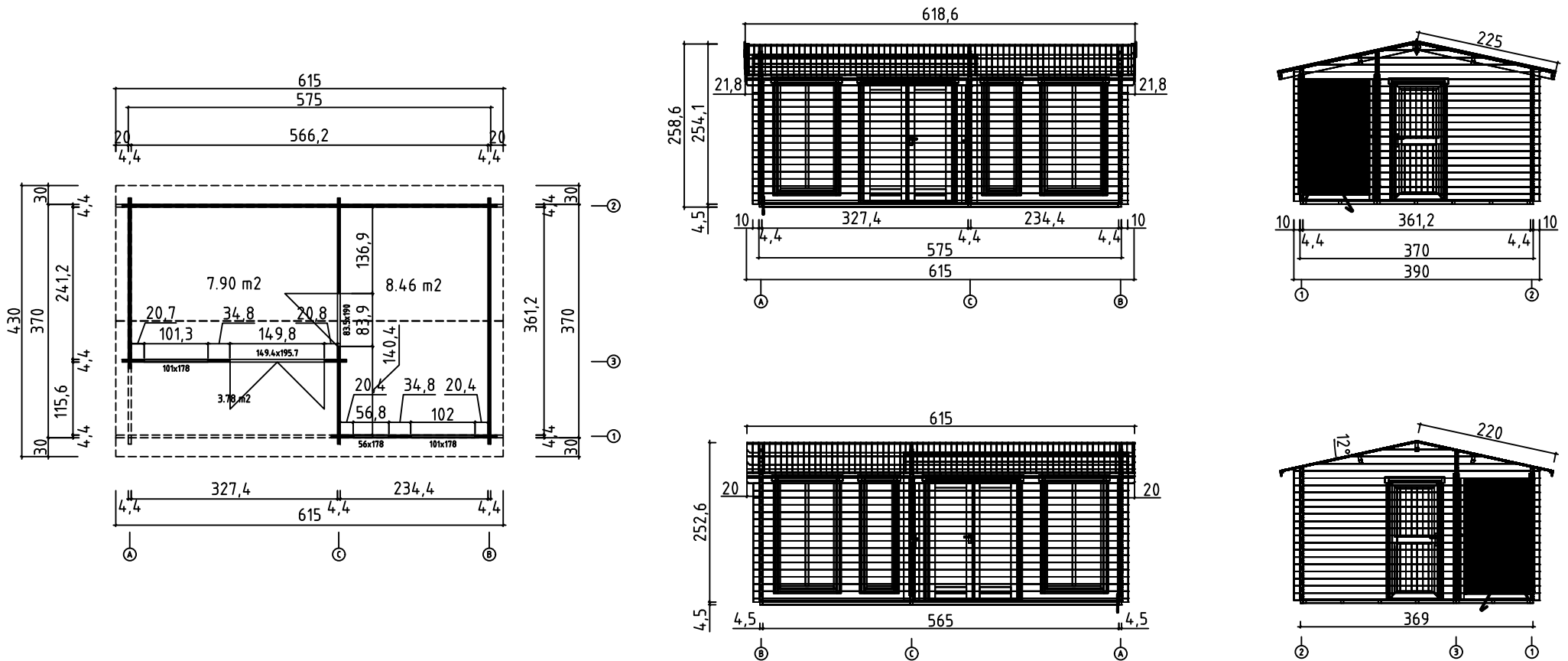

Art. Nr. 4419902

Planritning - Grunnplan - Grundplan - Pohjapiirustus

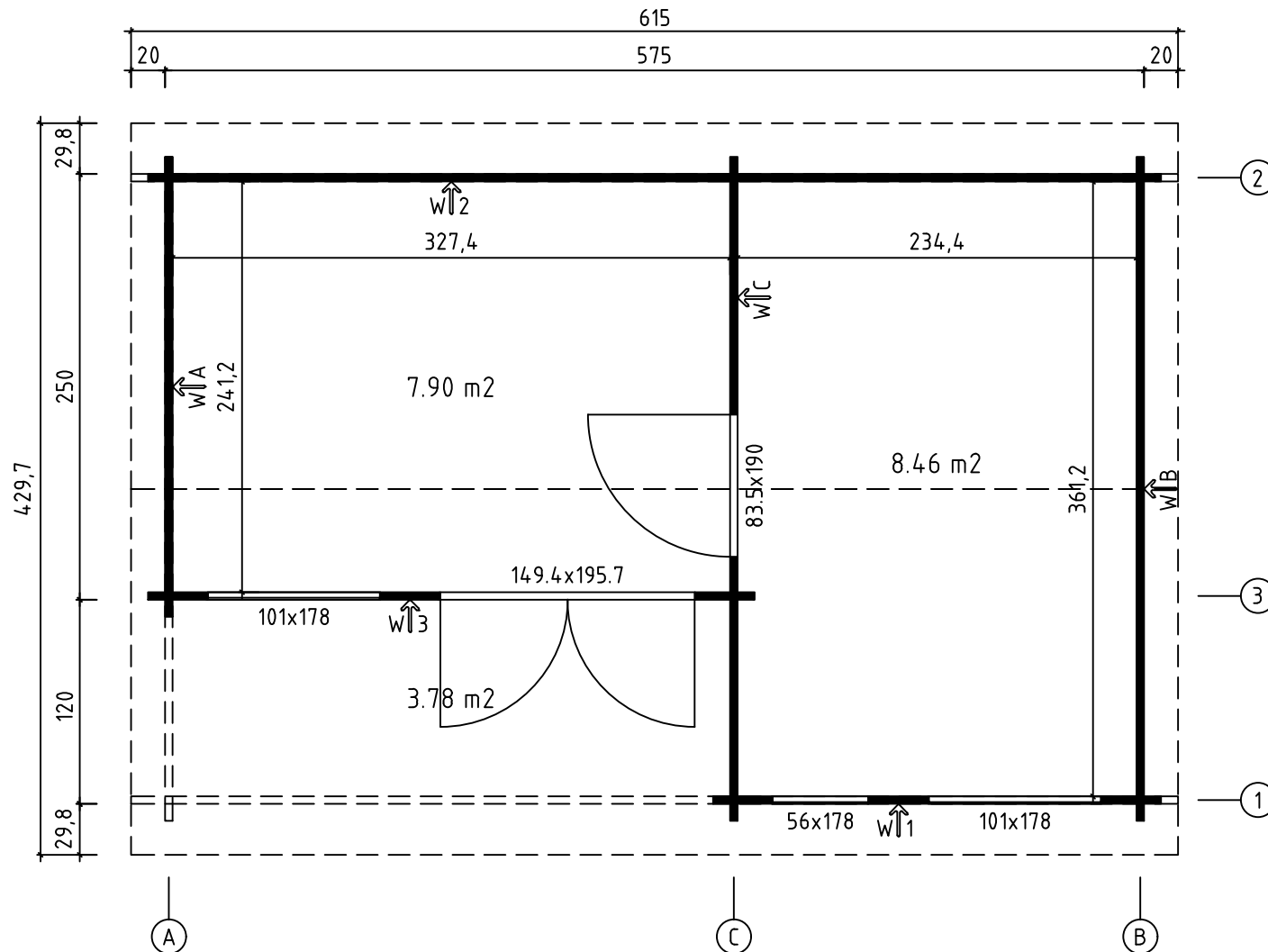

Grund - Grunnmur - Fundament - Perustus

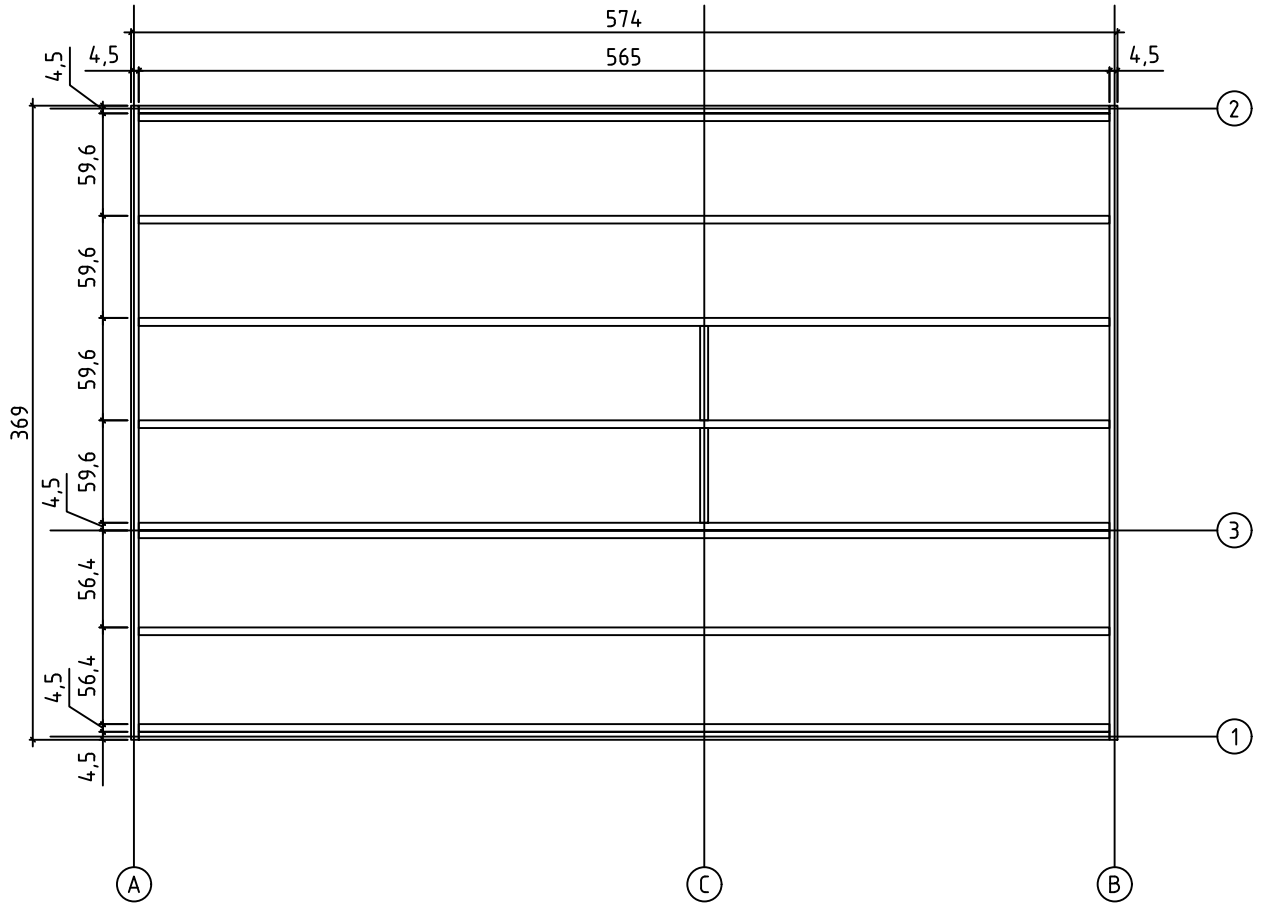

Golvbrädor - Golvboard - Golvbrædder - Lattialaudat
Terrassbrädor - Terrassebord - Terrassebrædder - Terrasilauta

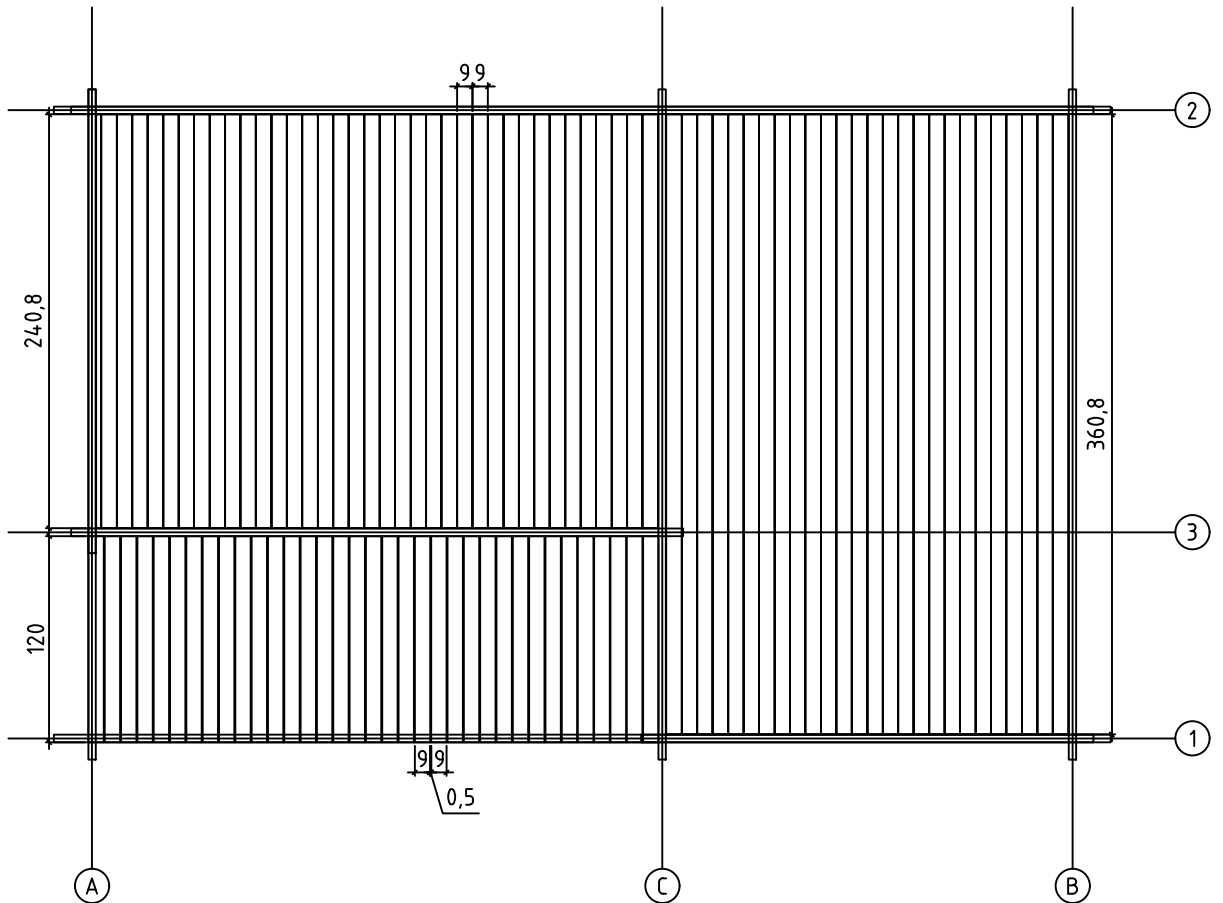

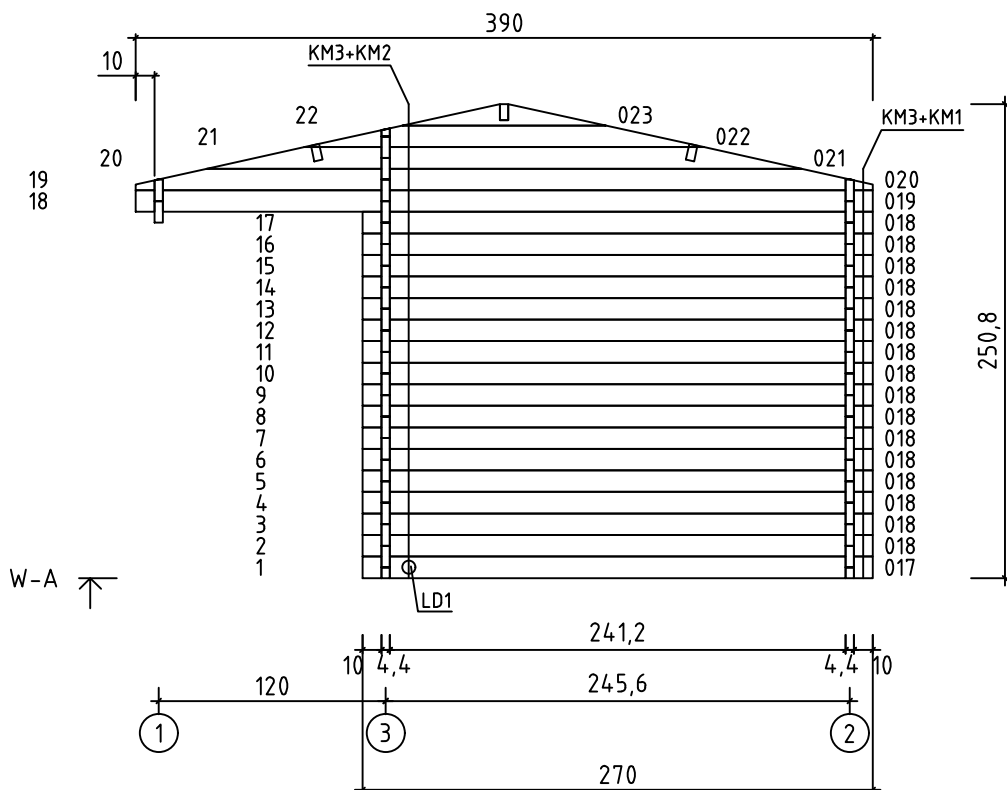
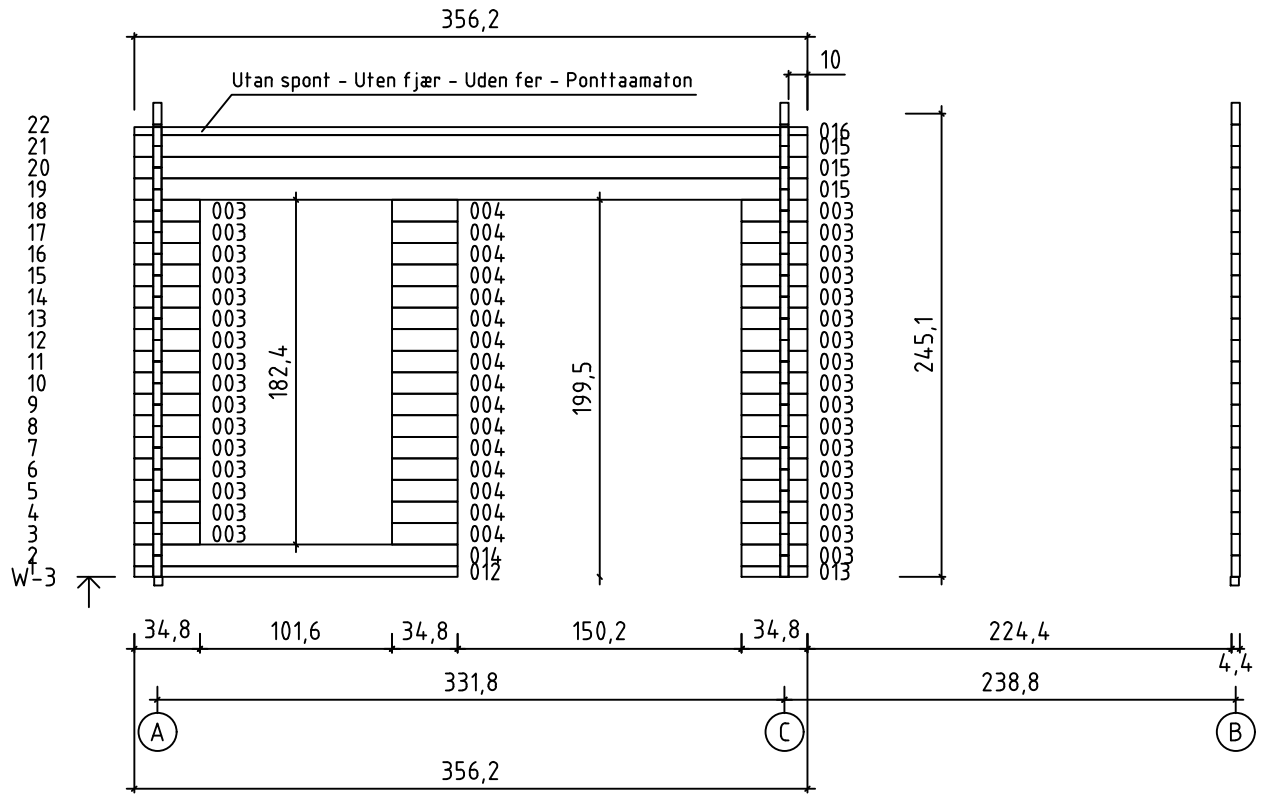

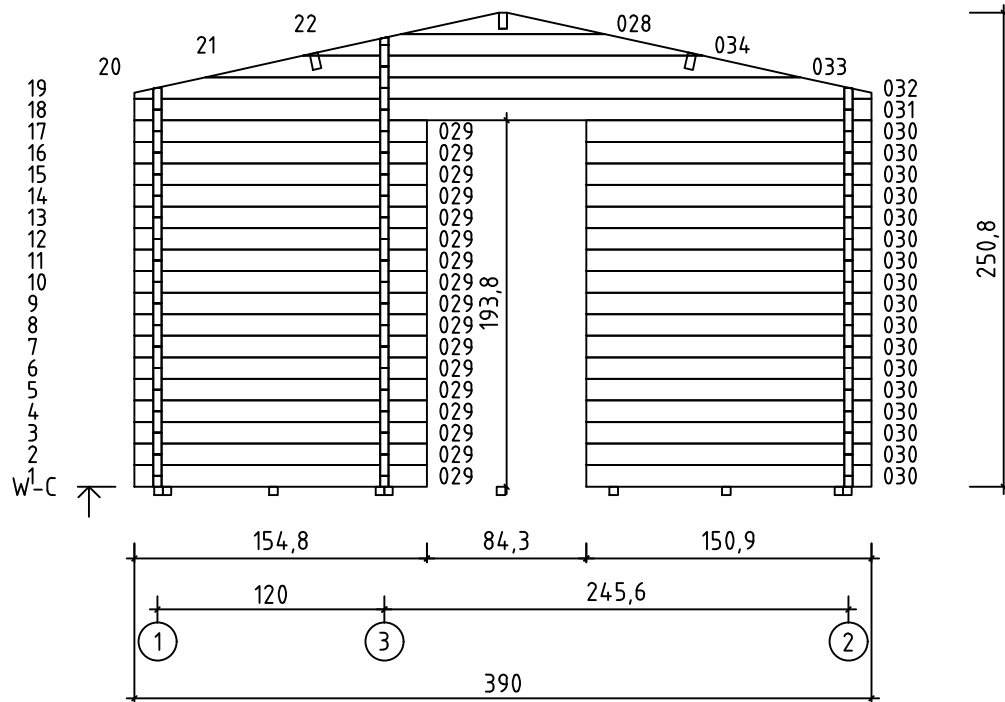
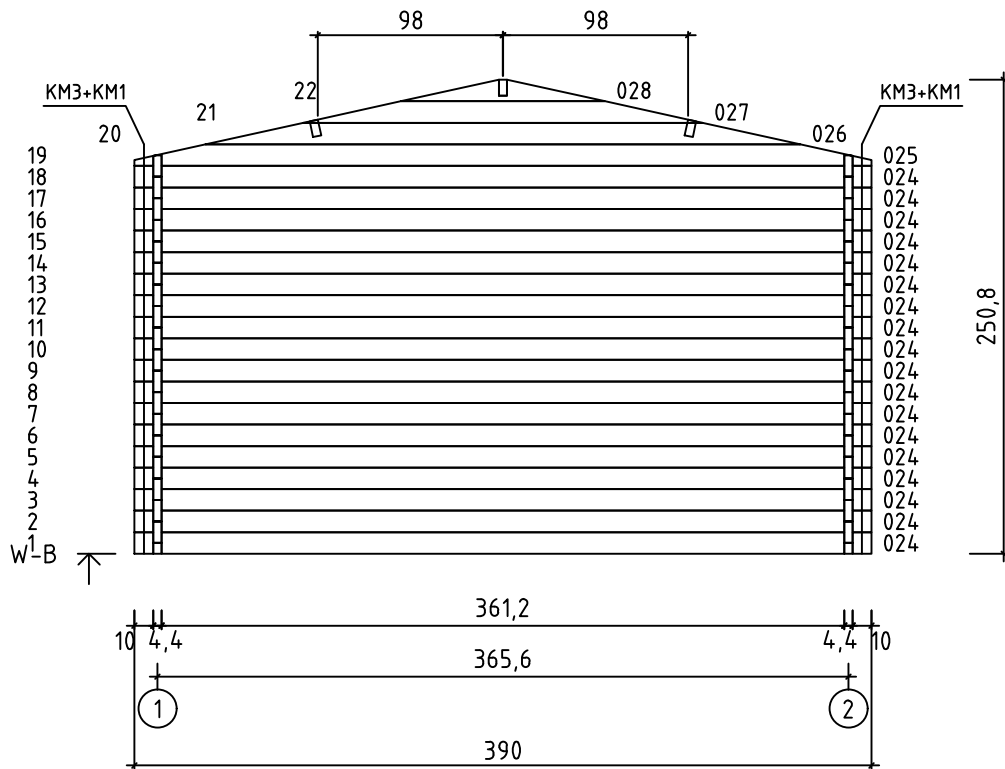

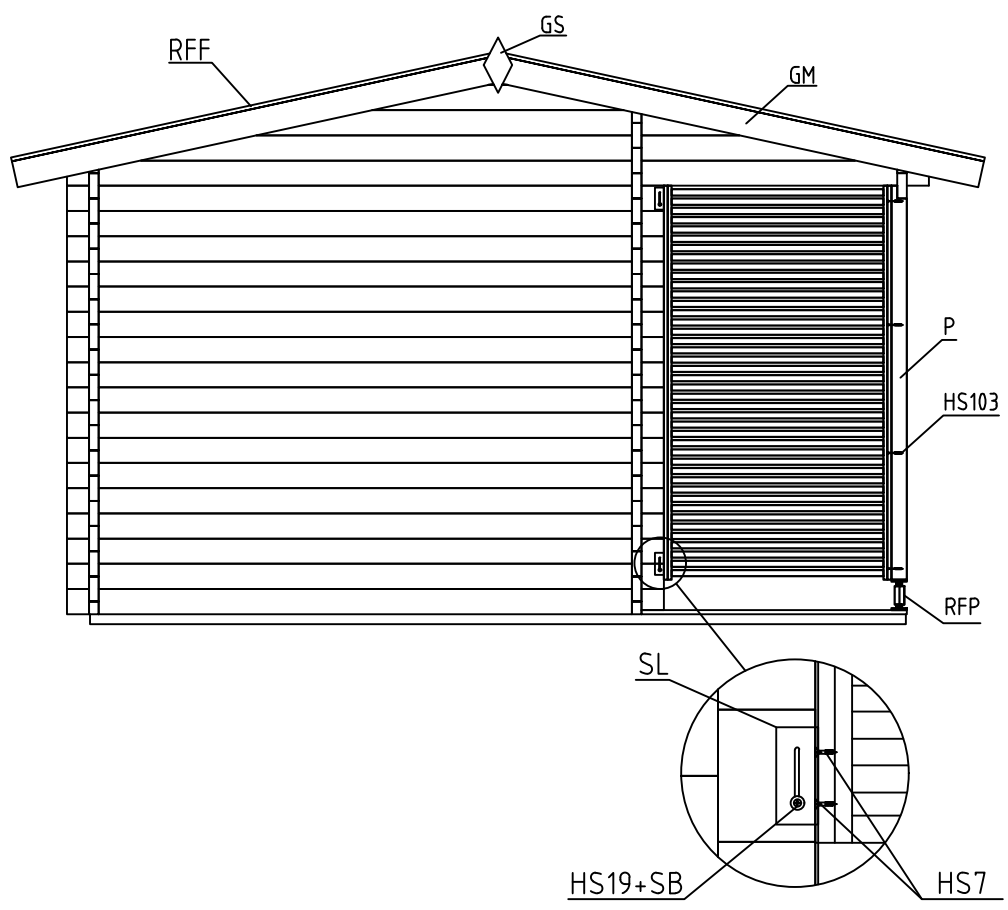



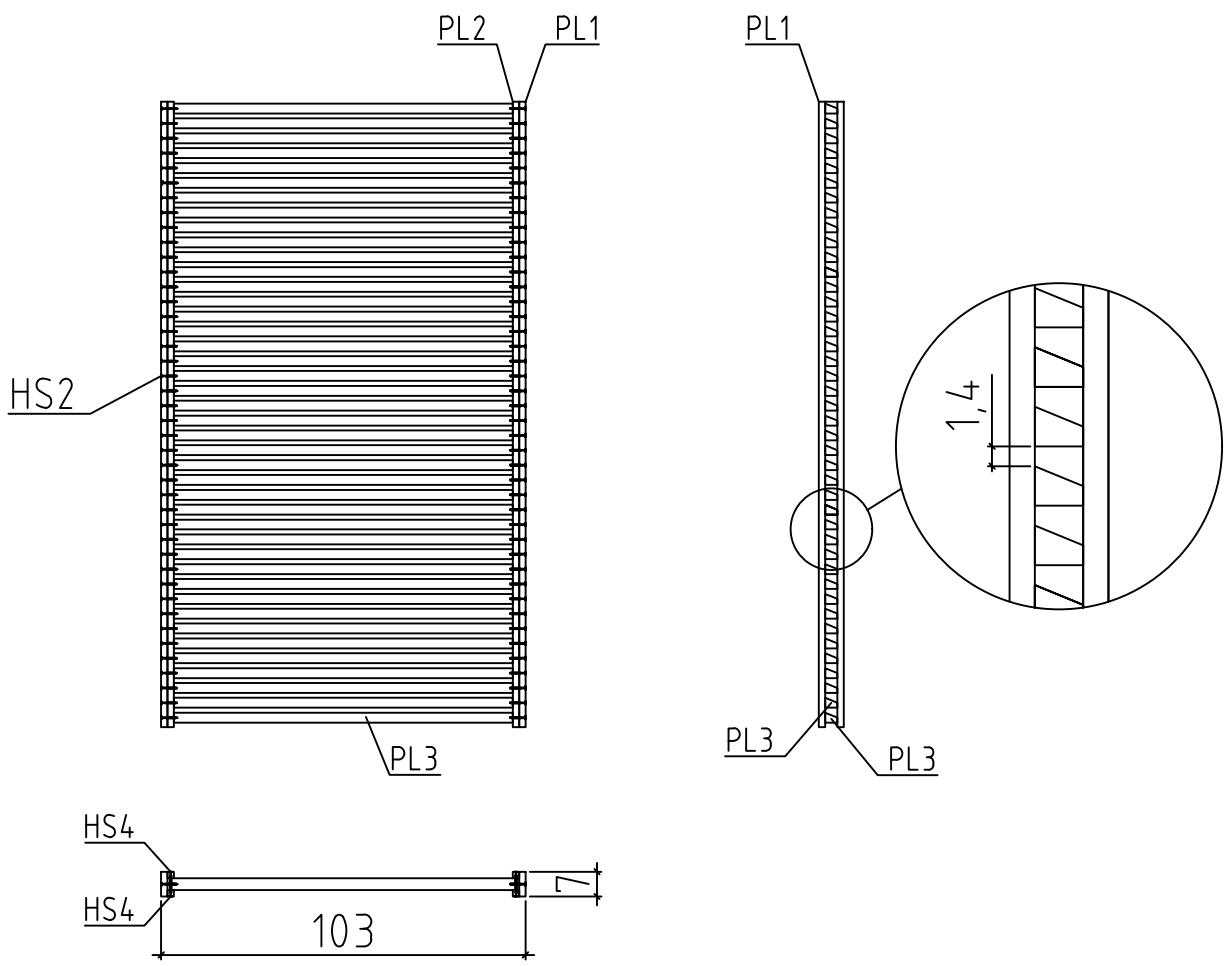

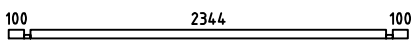
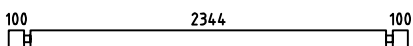

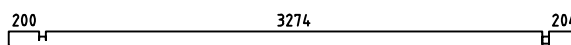

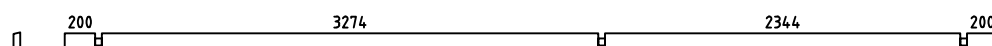
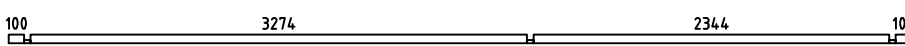
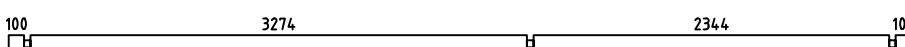
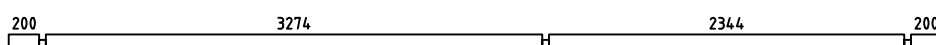
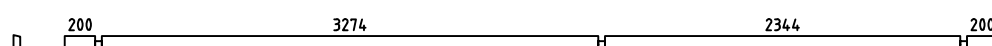
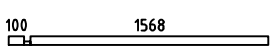

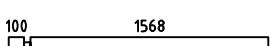
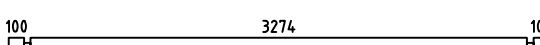
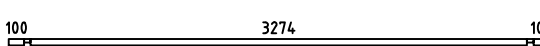
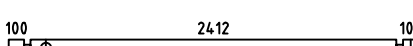
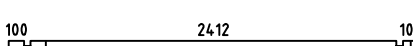
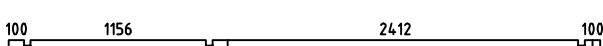
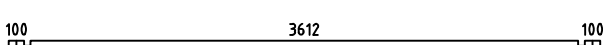
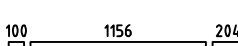
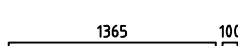
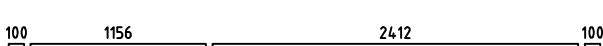







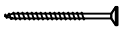
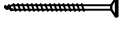

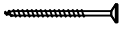

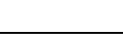
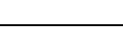
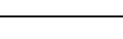
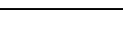
Terrasseräcke - Terrasserekverk - Terrassegeländer - Terrassikaide

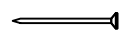

Pos	30.05.2018 Delförteckning - Liste over deler - Stykliste - Osaluettelo Art. Nr. 4419902	9/12	Q	P (mm)	L (mm)
001			1	44x57	2632
002			1	44x114	2632
003			63	44x114	348
004			32	44x114	348
005			1	44x114	3766
006			1	44x114	448
007			1	44x120	6150
008			1	44x57	5950
009			16	44x114	5950
010			1	44x114	6150
011			1	44x120	6150
012			1	44x57	1712
013			1	44x57	348
014			1	44x114	1712
015			3	44x114	3562
016			1	44x42	3562
017			1	44x114	2700
018			16	44x114	2700
019			1	44x114	3900
024			18	44x114	3900
029			17	44x114	1548
030			17	44x114	1509
031			1	44x114	3900

Pos	30.05.2018 Delförteckning - Liste over deler - Stykliste - Osaluettelo Art. Nr. 4419902	10/12	Q	P (mm)	L (mm)
WA-1			1		
WB-1			1		
WC-1			1		
IAR3	Grund - Grunnmur - Fundament - Perustus 		10	45x45	5650
IAR1	Grund - Grunnmur - Fundament - Perustus 		2	45x45	3690
IAR2	Grund - Grunnmur - Fundament - Perustus 		2	45x45	551
A-PR1	Tåkassar - Takbjelke - Tagbjælke - Katto-orret 		3	44x140	6150
	Golvbrädor - Gulvbord - Gulvbrædder - Lattialaudat 		26	90x18	3608
	Golvbrädor - Gulvbord - Gulvbrædder - Lattialaudat 		37	90x18	2408
	Terrassbrädor - Terrassebord - Terrassebrædder - Terassilauta 		35	90x19	1200
	Takbräde - Takbord - Tagbrædder - Kattolauta 		138	90x18	2200
	Golvläkt - Gulvlist - Gulvliste - Jalkalista 			18x18	23.25
RFF	Takläkt - List for takpapp - Tagpaplister - Kattohuopalistat 		4	18x58	2250
KM1	Gängad stång m10 - Gjengestang m10 - Gevindstang m10 - Kierretanko m10 		3		125
KM2	Gängad stång m10 - Gjengestang m10 - Gevindstang m10 - Kierretanko m10 		1		340
KM3	Gängad stång m10 - Gjengestang m10 - Gevindstang m10 - Kierretanko m10 		4		2000
PL1	List till terrassräcke - List for terrasserekker - Lægte til terrassegeländer - Terassikaiteen lista 		4	18x18	1782
PL2	List till terrassräcke - List for terrasserekker - Lægte til terrassegeländer - Terassikaiteen lista 		42	28x34	994
PL3	List till terrassräcke - List for terrasserekker - Lægte til terrassegeländer - Terassikaiteen lista 		2	18x70	1782
P	Stolpe - Søjle - Stolpe - Pilari 		1	70x70	1782
TB-1	Takfotsinklädning - Speilbord - Sternbræt - Ræystäslauta 		4	18x90	3075
DRV-1	Takfot - Forsterkning av takforkant - Tagkantsforsterkning - Ræystäslista 		4	28x34	3075
	Vindbräde - Vindski - Vindskede - Kaapelilauta 		4	18x120	2250

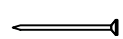
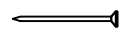
Pos	30.05.2018 Delförteckning - Liste over deler - Stykliste - Osaluettelo Art. Nr. 4419902	11/12	Q	P (mm)	L (mm)
LD1	Lock för gängstångshål - Lokk for gjengestanghull - Afdækning for gevindstangsåbning - Kierretangon aukon kansi		1		
	Skarvmutter för gängstång - Forlængelsesbolt for gjengestang - Forlængelsesmøtrik til gevindstang - Kierretangon pidennysmutteri		4	D10	
HS7	Skruv för bindbjälke till skjutvägg - Skrue for skyvedørsfeste - Skrue til skydebeslag til væg - Seinän liukukiinnikkeen ruuvi		8	3.5x20	
HS8	Skruv för gavelsegment - Skrue for gavledel - Skrue til gavlsegment - Koristepalan ruuvi		4	3.5x35	
HS9	Skruv för gavelläkt - Skrue for vindski - Skrue til vindskede - Harjalistan ruuvi		24	3.5x50	
HS4	Skruv för täcklist - Skrue for dekkbord - Skrue til dækliste - Kateprofiilin ruuvi		20	3x30	
HS103	Skruv för täcklist - Skrue for dekkbord - Skrue til dækliste - Kateprofiilin ruuvi		4	4.5x80	
HS12	Skruv för täcklist - Skrue for dekkbord - Skrue til dækliste - Kateprofiilin ruuvi		84	4x40	
HS12	Skruv för takfotsinklädning - Skrue for speilbord - Skrue til sternbrædder - Ræystäslaudan ruuvi		28	4x40	
HS12	Skruv för förstärkningsreglar till takfot - Skrue for forsterkning av takforkant - Skrue til tagkantsforsterkning - Kafon reunan vahvistusruuvi		28	4x40	
HS13	Skruv för stolpe - Skrue for søyle - Skrue til stolpe - Pilarin ruuvi		2	4x60	
HS18	Skruv för takbjälkar - Skrue for takbjelker - Skrue til tagbjælker - Kattopalkin ruuvi		9	5x120	
HS18	Skruv för gaveltriangel - Skrue for gavl - Skrue til gavl - Päätykolmion ruuvi		24	5x120	
HS16	Skruv för 1. väggregel - Skrue for første stokklag - Skrue til første vægbjælke - 1. seinäpalkin ruuvi		11	5x90	
HS16	Skruv för grund - Skrue for grunnmur - Skrue til fundament - Perustuksen ruuvi		39	5x90	
HS19	Skruv för bindbjälke till skjutvägg - Skrue for skyvedørsfeste - Skrue til skydebeslag til væg - Seinän liukukiinnikkeen ruuvi		2	6x40	
HS20	Skruv för höjdjustering av post - Skrue for justering av søylehøyde - Skrue til højdejustering af stolpe - Tolpan korkeudensäätöruuvi		8	6x50	
NF2	Zn spik för golvläkt - Sinkstift for gulvlist - Zn søm til gulvliste - Sinkitty naula jalkalistan asennukseen		48	1.4x40	
SH44	Hammarkloss - Hoggestabbe - Træklods til hamring - Naulauskappale		1		
	Slagmutter för gängstång - Drivmutter for gjengestang - Drivmøtrik til gevindstang - Kierretangon ohjausmutteri		4	D10	
SFS	Mutter för gängstång - Mutter for gjengestang - Møtrik til gevindstang - Kierretangon mutteri		4	D10	
NF3	Förzinkad spik till terrass - Sinkspiker for terrasse - Zn søm til terrasse - Sinkitty terassinnaula		210	2.1x50	
NF4	Förzinkad takspik - Sinkspiker for tak - Zn søm til tag - Sinkitty kattonaula		472	2x50	

Pos	10.11.2017	Delförteckning - Liste over deler - Stykliste - Osaluettelo 560x1780 AK.1.100.TPSP DGP+	1/1	Q	P (mm)	L (mm)
-----	------------	--	-----	---	-----------	-----------

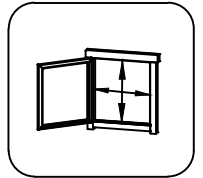
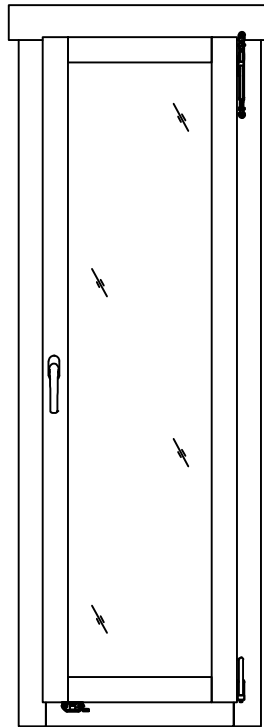

460x1684 mm

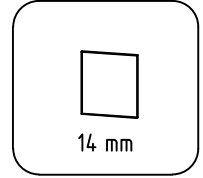

14 mm

390x1602 mm

FS2	Handtagsbeslag för fönster - Vridere til vinduer - Vindueshåndtag - Ikkunanpainikkeet		1		
-----	--	---	---	--	--

Pos

10.11.2017

Delförteckning - Liste over deler - Stykliste - Osaluettelo
1010x1780 TAK.1.100.TPM0.e DGP+

1/1







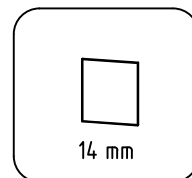
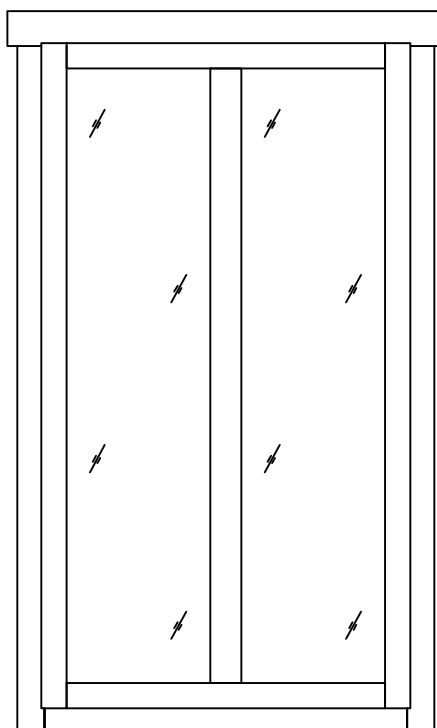

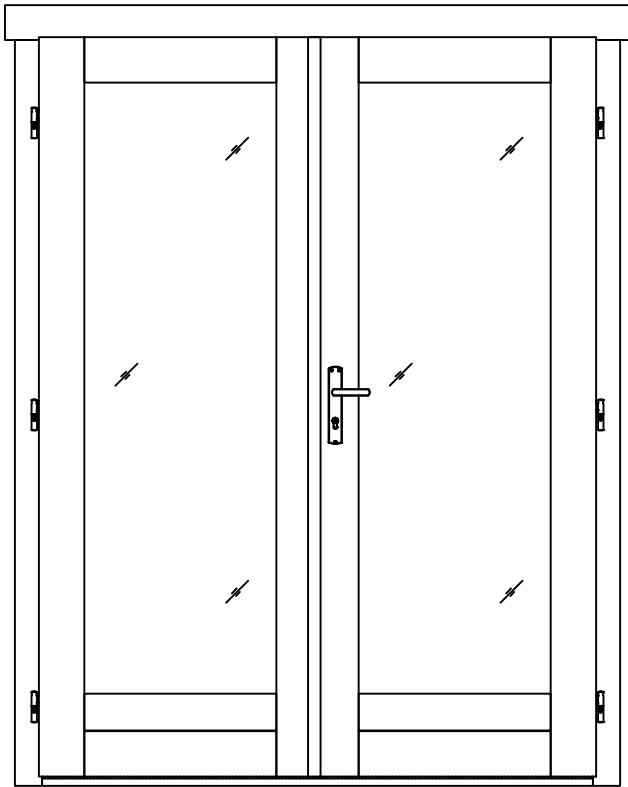
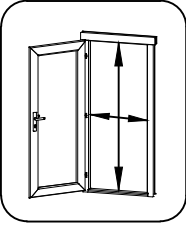
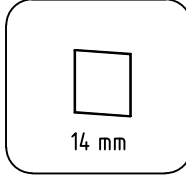

Q



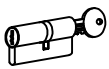

P
(mm)

L
(mm)

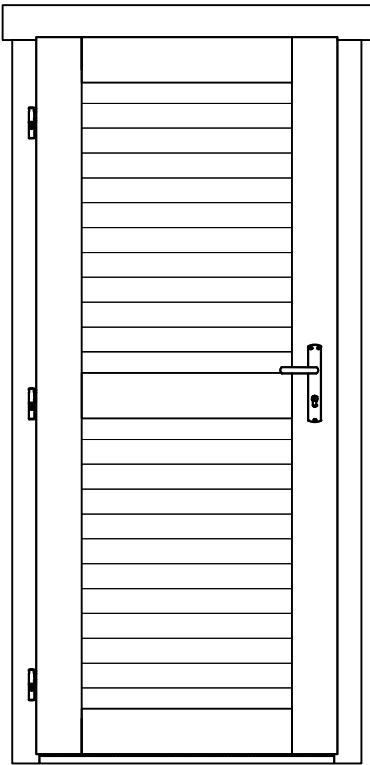
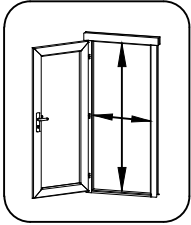
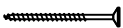
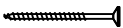

390x1602 mm

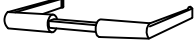
Pos	10.11.2017	Delförteckning - Liste over deler - Stykliste - Osaluettelo 1494x1957 TUK.1.100.TPVP.MMb DGP+	1/1	Q	P (mm)	L (mm)
						
					 1394x1873 mm	
					 14 mm	 514x1593 mm
HS4	Skruv för golvläkt - Skruer for dørliste - Skruer til dørliste - Ovilistan asennusruuvi		5	3x30		
HS16	Skruv för dörrkarm - Skruer for dørstolpe - Skruer til dørkarm - Oven karmin ruuvi		4	5x90		
HS25	Skruv för dörrträskel - Skruer for terskel - Skruer til dørtrin - Kynnyksen ruuvi		3	4.5x65		
MH	Gångjärn för dörr - Bolt for dørhengsel - Hanskrue til dørhengsel - Oven sarana		6	14x80		
HC	Gångjärnsskåpor för dörr - Deksel over hengsle - Hængsel-dæksel - Oven saranasuoja		12			
TL4	Handtag för dörr - Dørbeslag - Dørhåndtag - Ovenpainike		1			
TL5	Sats med täckbrickor för dörrlås - Et sett av dørbeslag - Sæt af låsedækster - Lukkokilpisaarja		1			
	Cylinder - Sylindertilås - Cylinderlås - Sylinterilukko		1	30x35		
	Låsets slutstykke - Fallelåsens sluttstykke - Låsens slutstykke - Ovensalvan vastakappale		2			

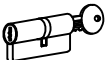
Pos	12.05.2016	Delförteckning - Liste over deler - Styklister - Osaluettelo 835x1900 UL.2.100.IVV.MMd TP+	1/1	Q	P (mm)	L (mm)
		  <p>735x1818 mm</p>				
HS16	Skruv för dörrkarm - Skrue for dørstolpe - Skrue til dørkarm - Oven karmin ruuvi			4	5x90	
HS25	Skruv för dörrtröskel - Skrue for terskel - Skrue til dørtrin - Kynnyksen ruuvi			3	4.5x65	
MH	Gångjärn för dörr - Bolt for dørhengsel - Hanskrue til dørhengsel - Oven sarana			6	14x80	
TL4	Handtag för dörr - Dørbeslag - Dørhåndtag - Ovenpainike			1		
TL5	Sats med täckbrickor för dörrlås - Et sett av dørbeslag - Sæt af låsedækster - Lukkokilpisarja			1		
	Cylinder - Sylindertås - Cylinderlås - Sylinterilukko			1	30x35	