

Torquay 44  
Art. Nr. 4417502  
1/1€



Art.Nr. 4417502

1:100

FASADER OCH GRUNDPLAN - VISNINGER OG GRUNNPLAN -  
TEGNINGER OG GRUNDPLAN - JULKISIVUT JA POHJAPIIRUSTUS

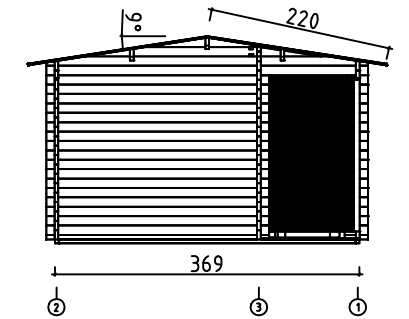
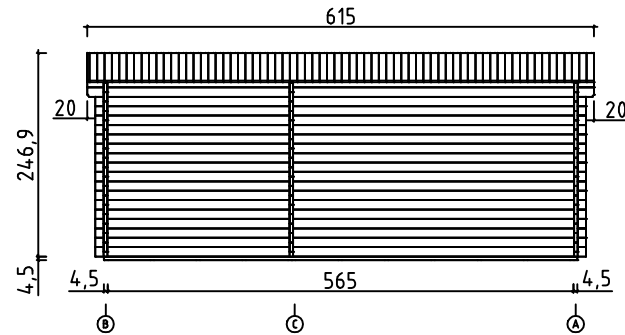
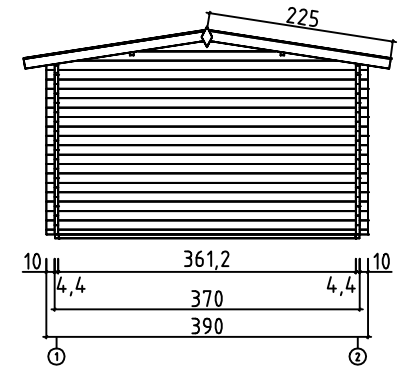
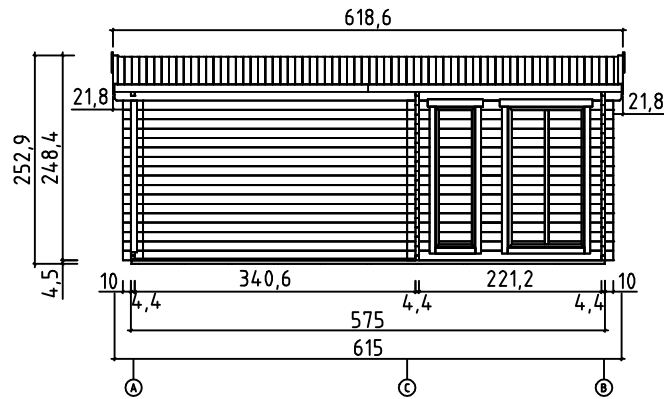
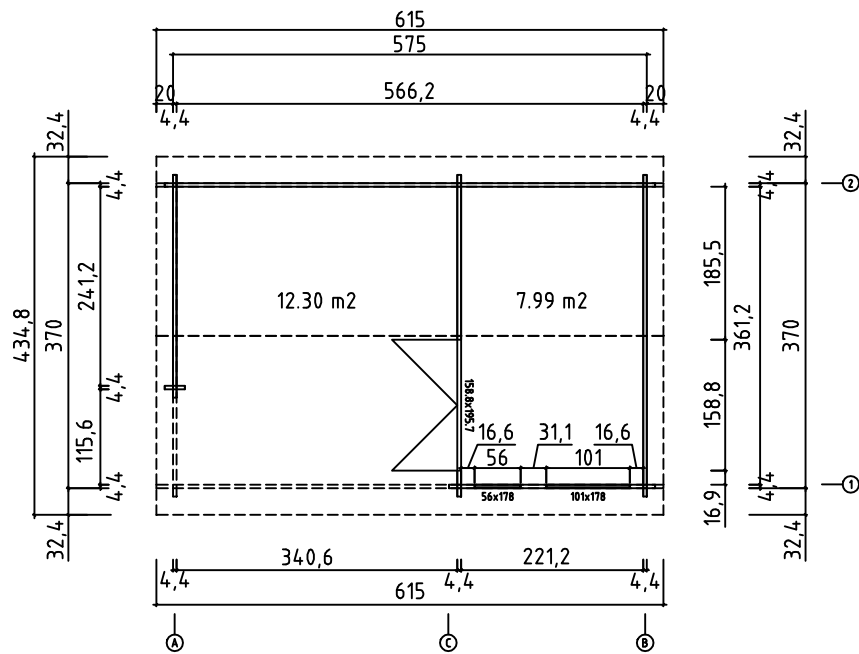

Art.Nr. 4417502

PLANRITNING - GRUNNPLAN - GRUNDPLAN - POHJAPIIRUSTUS

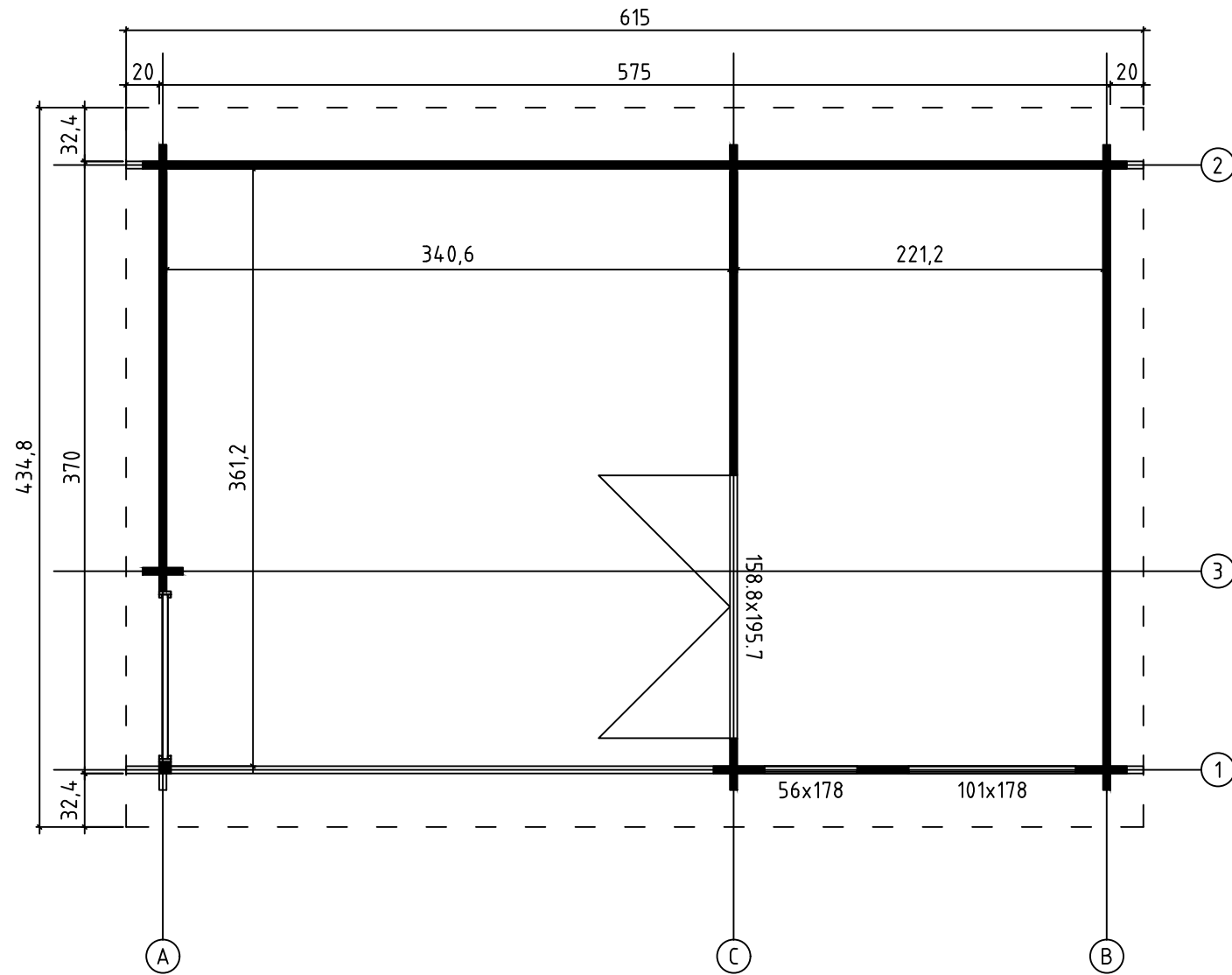

GRUND - GRUNNMUR - FUNDAMENT - PERUSTUS

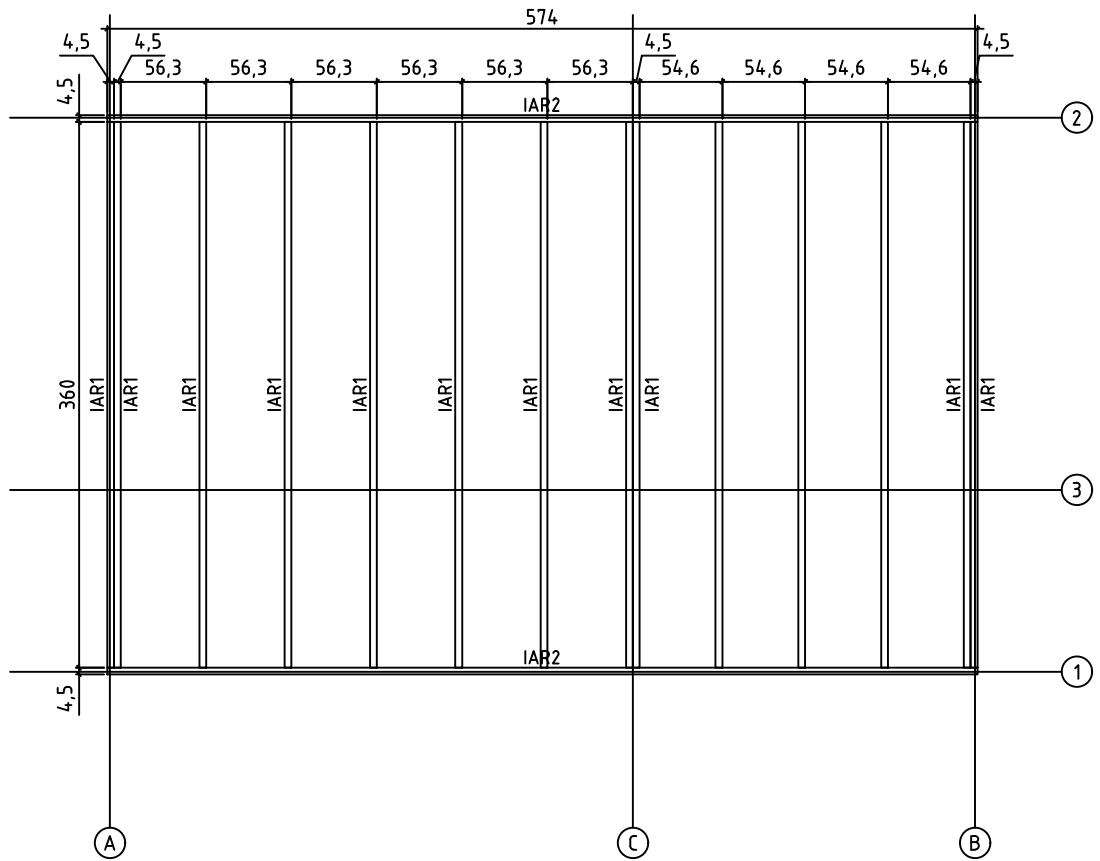

GOLVBRÄDOR - GULVBORD - GULVBRÆDDER - LATTIALAUDAT  
TERRASSBRÄDOR - TERRASSEBORD - TERRASSEBRÆDDER - TERASSILAUTA

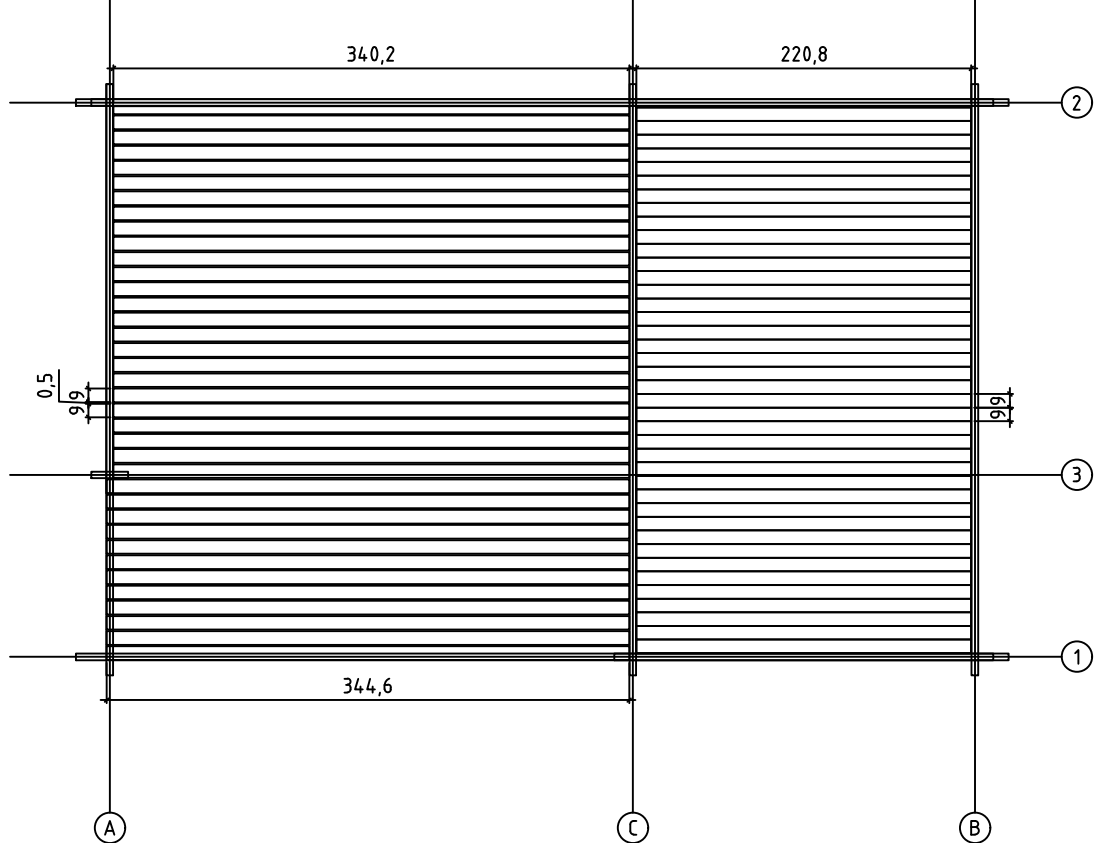

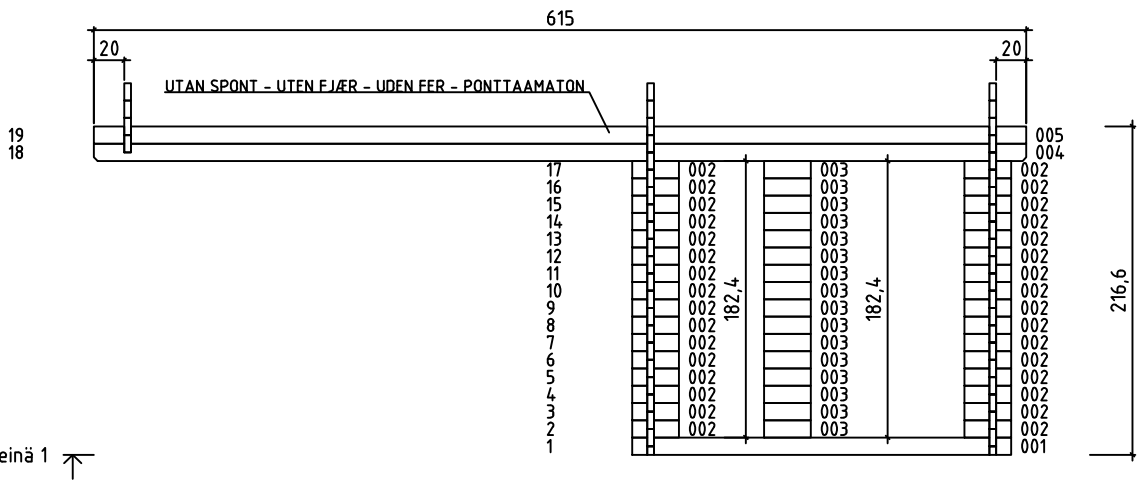

Vägg-Vegg-Væg-Seinä 1 ↑

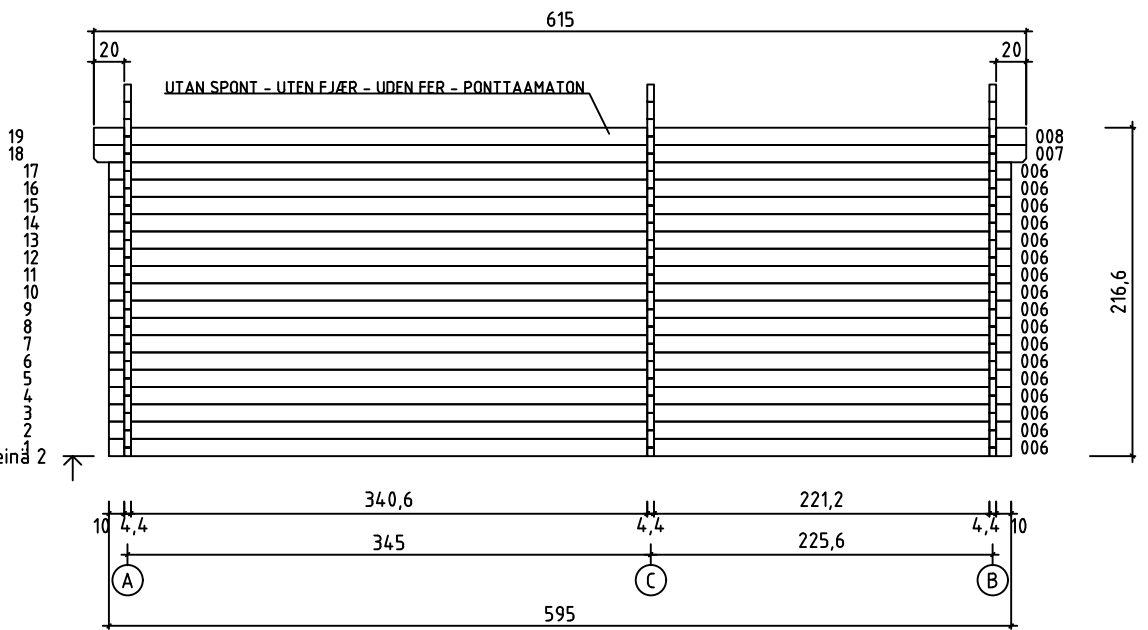

Vägg-Vegg-Væg-Seinä 2 ↑

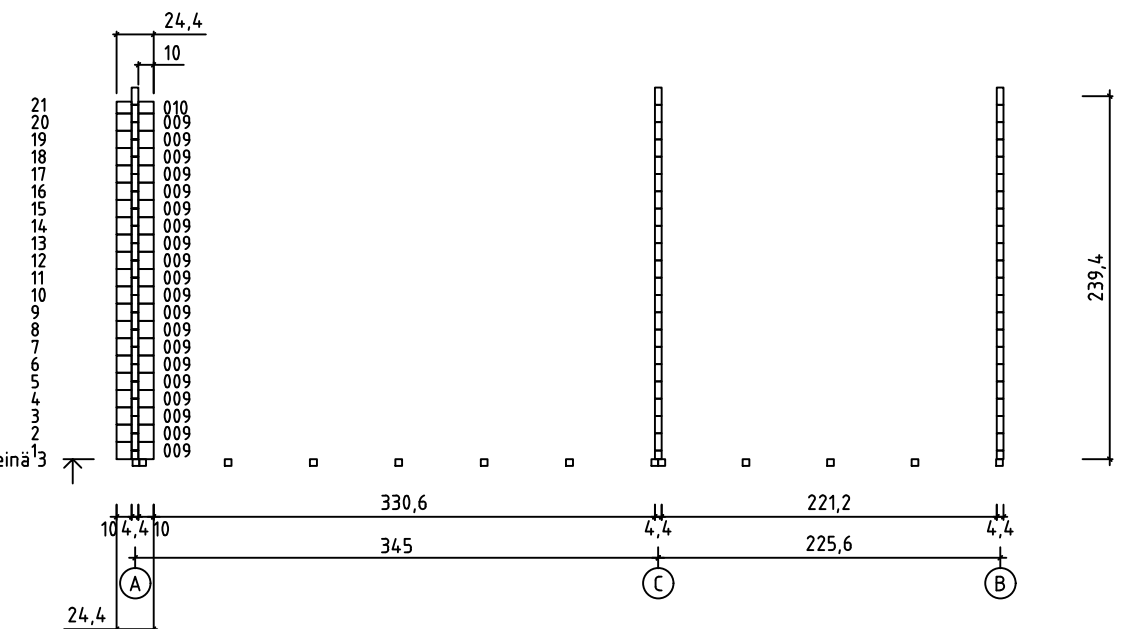



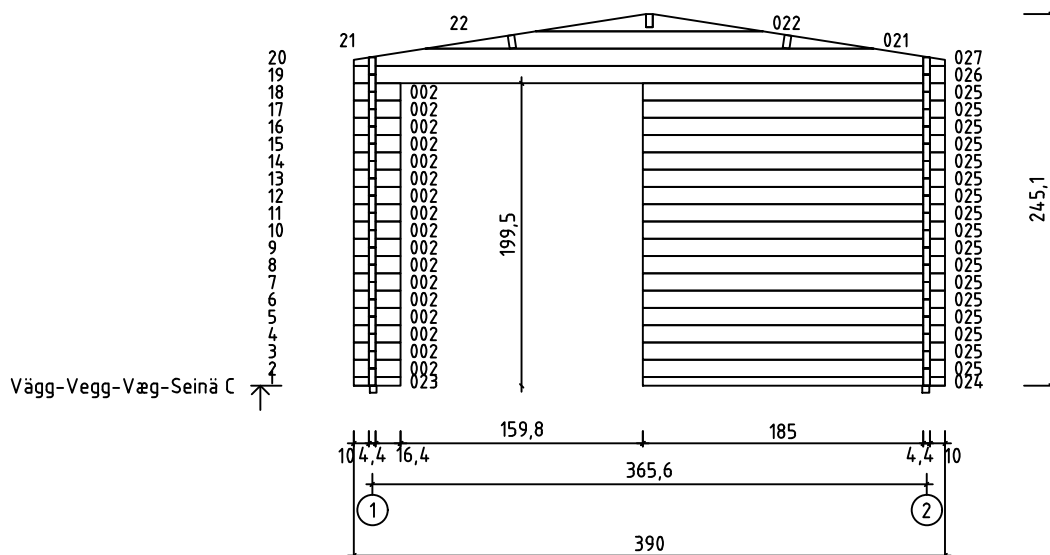
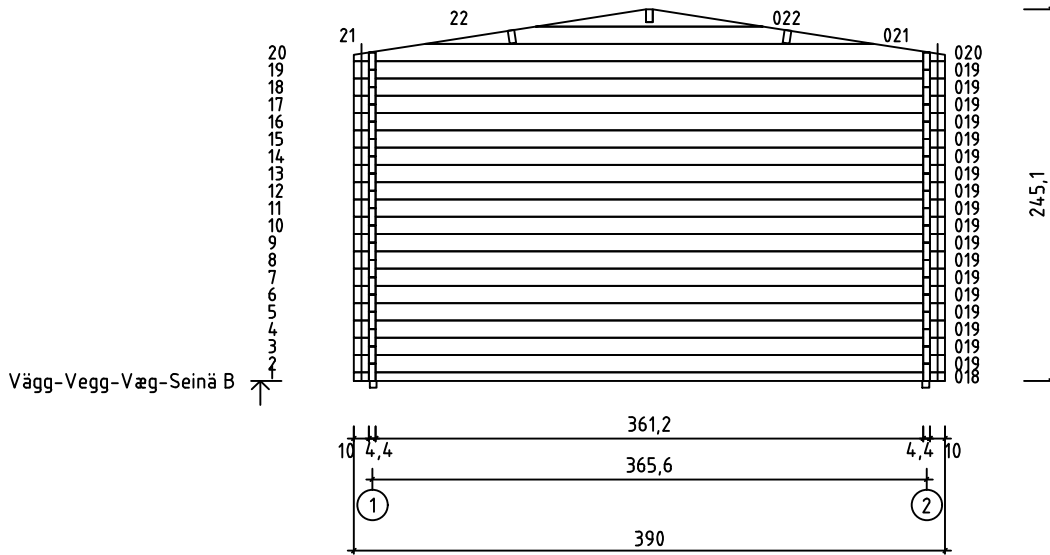
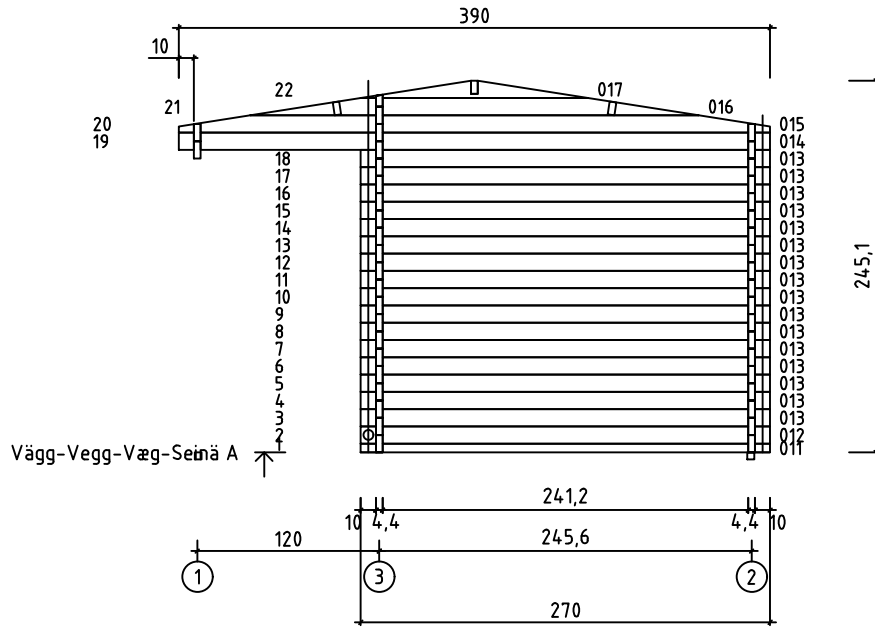

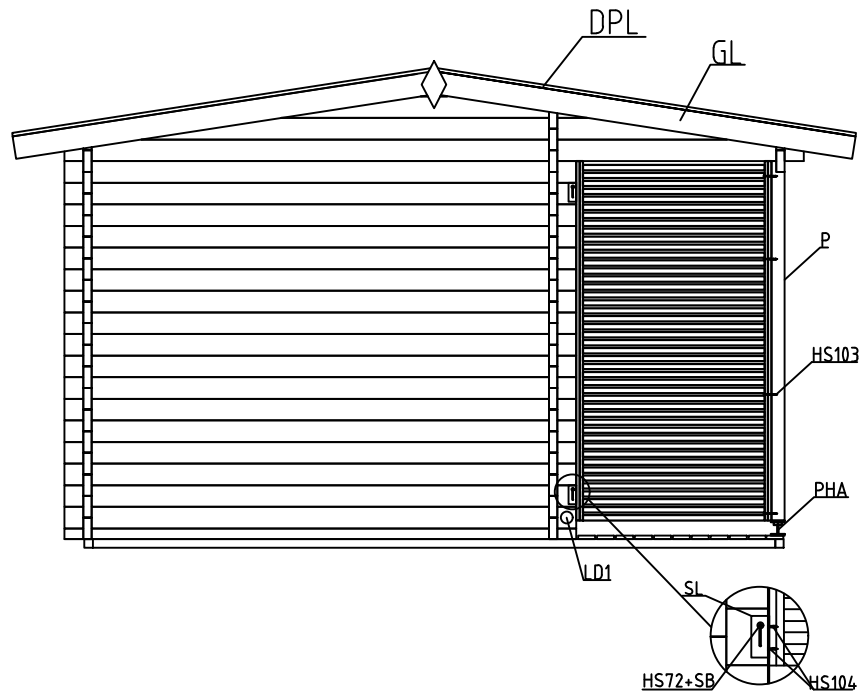
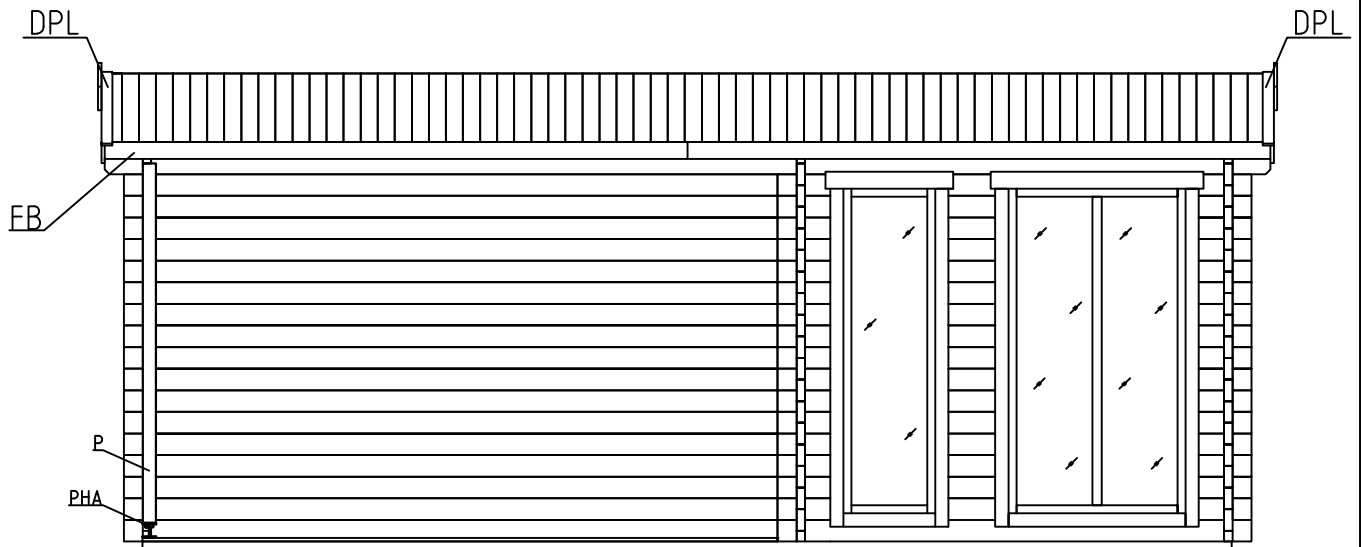

Vägg-Vegg-Væg-Seinä 3 ↑

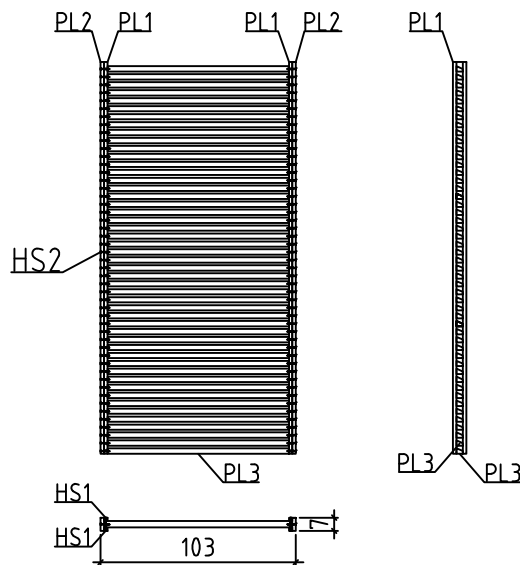

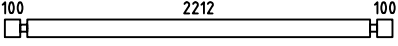

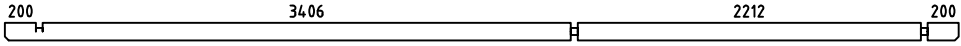
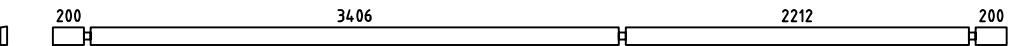
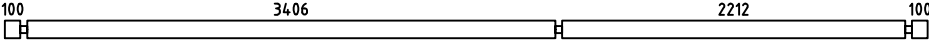
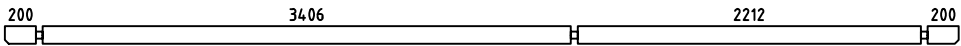
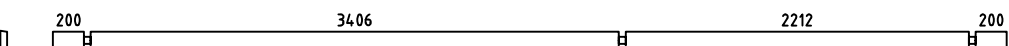
TERRASSRÄCKE - TERRASSEREKKVERK - TERRASSEGELÄNDER - TERASSIKAITEEN

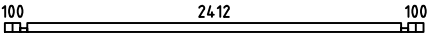
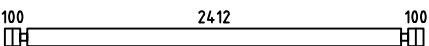
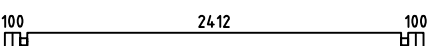
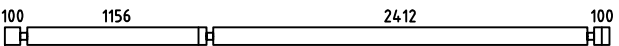
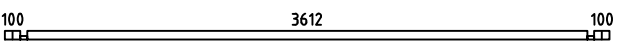
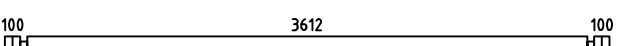

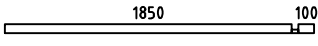
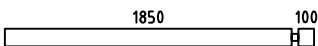
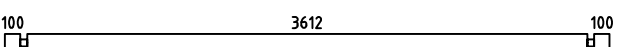
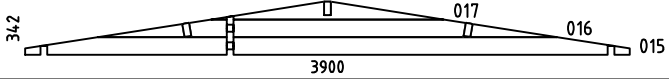
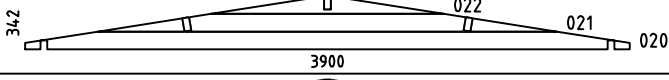
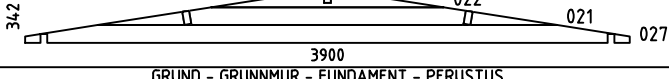
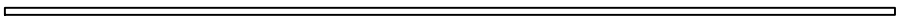
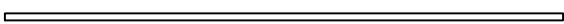





Pos	23.04.2018 Delförteckning - Liste over deler - Styklister - Osaluettelo Art.Nr. 4417502	8/10	Q.	P (mm)	L (mm)
001			1	44x114	2500
002			49	44x114	308
003			16	44x114	308
004			1	44x114	6150
005			1	44x120	6150
006			17	44x114	5950
007			1	44x114	6150
008			1	44x120	6150
009			20	44x114	244
010			1	44x80	244
011			1	44x57	2700
012			1	44x114	2700
013			16	44x114	2700
014			1	44x114	3900
018			1	44x57	3900
019			18	44x114	3900
023			1	44x57	308
024			1	44x57	1994
025			17	44x114	1994
026			1	44x114	3900
WA-1			1		
WB-1			1		
WC-1			1		
IAR2	GRUND - GRUNNMUR - FUNDAMENT - PERUSTUS 		2	45x45	5740
IAR1	GRUND - GRUNNMUR - FUNDAMENT - PERUSTUS 		14	45x45	3600

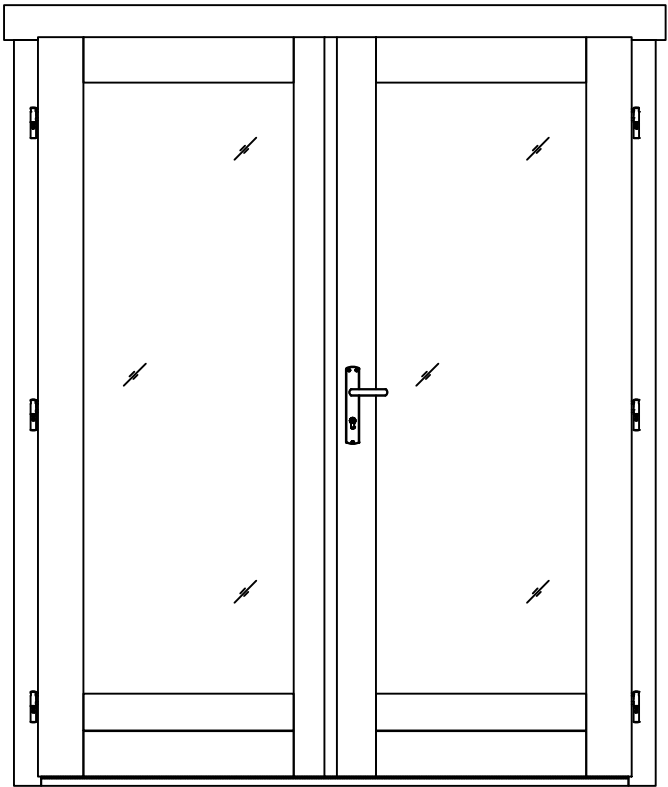
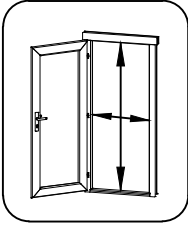
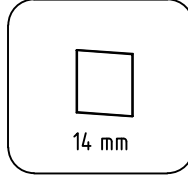
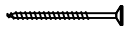
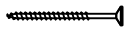
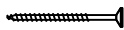

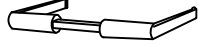
Pos	23.04.2018 Delförteckning - Liste over deler - Styklister - Osaluettelo Art.Nr. 4417502	9/10	Q.	P (mm)	L (mm)
A-PR1	TÅKASAR - TAKBJELKE - TAGBJÆLKE - KATTO-ORRET 3406 2212 200		3	44x140	6150
	GOLVBRÄDOR - GULVBORD - GULVBRÆDDER - LATTIALAUDAT		41	90x18	2208
	TERRASSBRÄDOR - TERRASSEBORD - TERRASSEBRÆDDER - TERASSILAUTA		12	90x19	3446
	TERRASSBRÄDOR - TERRASSEBORD - TERRASSEBRÆDDER - TERASSILAUTA		27	90x19	3402
	KATTOLAUTA - TAKBORD - TAGBRÆDDER - TAKBRÆDE		138	90x18	2200
	GOLVLÄKT - GULVLIST - GULVLISTE - JALKALISTA			18x18	11.63
DPL	TAKLÄKT - LIST FOR TAKPAPP - TAGPAPLISTE - KATTOHUOPALISTA		4	18x58	2250
	GÄNGAD STÅNG M10 - GJENGESTANG M10 - GEVINDSTANG M10 - KIERRETANKO M10		3		180
	GÄNGAD STÅNG M10 - GJENGESTANG M10 - GEVINDSTANG M10 - KIERRETANKO M10		1		250
	GÄNGAD STÅNG M10 - GJENGESTANG M10 - GEVINDSTANG M10 - KIERRETANKO M10		4		2000
PL1	LIST TILL TERRASSRÄCKE - LIST FOR TERRASSEREKKVERK - LÆGTE TIL TERRASSEGELÆNDER - TERASSIKAITEEN LISTA		4	18x18	1896
PL2	LIST TILL TERRASSRÄCKE - LIST FOR TERRASSEREKKVERK - LÆGTE TIL TERRASSEGELÆNDER - TERASSIKAITEEN LISTA		2	18x70	1896
PL3	LIST TILL TERRASSRÄCKE - LIST FOR TERRASSEREKKVERK - LÆGTE TIL TERRASSEGELÆNDER - TERASSIKAITEEN LISTA		45	28x34	994
P	STOLPE - SØYLE - STOLPE - PILARI		1	70x70	1826
FB	TAKFOTSINKLÄDNAD - SPEILBORD - STERNBRÆT - RÄYSTÄSLAUTA		4	18x90	3075
	TAKFOT - FORSTERKNING AV TAKFORKANT - TAGKANTSFORSTÆRKNING - RÄYSTÄSLISTA		4	28x34	3075
GL	VINDBRÄDE - VINDSKI - VINDSKEDE - KAAPILILAUTA		4	18x120	2250
LD1	LOCK FÖR GÄNGSTÅNGSHÅL - LØKK FOR GJENGESTANGHULL - AFDÆKNING FOR GEVINDSTANGSÅBNING - KIERRETANGON AUKON KANSI		1		
	SKARVMUTTER FÖR GÄNGSTÅNG - FORLENGELSEBOLT FOR GJENGESTANG - FORLÆNGELSESMØTRIK TIL GEVINDSTANG - KIERRETANGON PIDENNYSMUTTERI		4		
HS104	SKRUV FÖR BINDBJÄLKE TILL SKJUTVÄGG - SKRUE FOR SKYVEDØRSFESTE - SKRUE TIL SKYDEBESLAG TIL VÆG - SEINAN LIUKUKIINNIKKEEN RUUVI		8	3.5x20	
	SKRUV FÖR GAVELSESEGMENT - SKRUE FOR GAVLEDEL - SKRUE TIL GAVLSEGMEN - KORISTEPALAN RUUVI		4	3.5x35	
	SKRUV FÖR STOLPE - SKRUE FOR SØYLE - SKRUE TIL STOLPE - PILARIN RUUVI		2	3.5x50	
	SKRUV FÖR GAVELLÄKT - SKRUE FOR VINDSKI - SKRUE TIL VINDSKEDE - HARJALISTAN RUUVI		24	3.5x50	
HS1	SKRUV FÖR TÄCKLIST - SKRUE FOR DEKKBORD - SKRUE TIL DÆKLISTE - KATEPROFIILIN RUUVI		20	3x30	
HS103	SKRUV FÖR MONTERING AV TERRASSRÄCKE - SKRUE FOR TERRASSEREKKVERK - SKRUE TIL TERRASSEGELÆNDER - TERASSIKAITEEN KIINNITYSRUUVI		4	4.5x80	

Pos	23.04.2018 Delförteckning - Liste over deler - Styklister - Osaluettelo Art.Nr. 4417502	10/10	Q.	P (mm)	L (mm)
HS2	SKRUV FÖR TÄCKLIST - SKRUE FOR DEKKBORD - SKRUE TIL DÆKLISTER - KATEPROFIILIN RUUVI		90	4x40	
	SKRUV FÖR TAKFOTSINKLÄDNAD - SKRUE FOR SPEILBORD - SKRUE TIL STERNBRÆDDER - RÄYSTÄSLAUDAN RUUVI		28	4x40	
	SKRUV FÖR TAKFOTSINKLÄDNAD - SKRUE FOR FORSTERKNING AV TAKFÖRKANT - SKRUE TIL TAGKANTSFORSTÆRKNING - RÄYSTÄSLAUDAN RUUVI		28	4x40	
	SKRUV FÖR TAKBJÄLKAR - SKRUE FOR TAKBJELKER - SKRUE TIL TAGBJÆLKER - KATTOPALKIN RUUVI		15	5x120	
	SKRUV FÖR GAVELTRIANGEL - SKRUE FOR GAVL - SKRUE TIL GAVL - PÄÄTYKOLMION RUUVI		6	5x120	
	SKRUV FÖR 1. VÄGGREGEL - SKRUE FOR FÖRSTE STOKKLAG - SKRUE TIL FÖRSTE VÆGBJÆLKE - 1. SEINÄPALKIN RUUVI		10	5x90	
	SKRUV FÖR GRUND - SKRUE FOR GRUNNMUR - SKRUE TIL FUNDAMENT - PERUSTUKSEN RUUVI		40	5x90	
HS72	SKRUV FÖR BINDBJÄLKE TILL SKJUTVÄGG - SKRUE FOR SKYVEDØRSFESTE - SKRUE TIL SKYDEBESLAG TIL VÆG - SEINÄN LIUKUKIINNIKKEEN RUUVI		2	6x40	
	SKRUV FÖR HÖJDJUSTERING AV POST - SKRUE FOR JUSTERING AV SØYLEHØYDE - SKRUE TIL HØJDEJUSTERING AF STOLPE - TOLPAN KORKEUDENSAATORUUVI		8	6x50	
	ZN SPIK FÖR GOLVLAKT - SINKSTIFT FOR GULVLIST - ZN SØM TIL GULVLISTER - SINKITTY NAULA JALKALISTAN ASENNUKSEEN		25	1.4x40	
	HAMMARKLOSS - HOGGESTABBE - TRÆKLODS TIL HAMRING - NAULAUSKAPPALE		1		
	SLAGMUTTER FÖR GÄNGSTÅNG - DRIVMUTTER FOR GJENGESTANG - DRIVMØTRIK TIL GEVINDSTANG - KIERRETANGON OHJAUSMUTTERI		4	D10	
	MUTTER FÖR GÄNGSTÅNG - MUTTER FOR GJENGESTANG - MØTRIK TIL GEVINDSTANG - KIERRETANGON MUTTERI		4		
	FÖRZINKAD SPIK TILL TERRASS - SINKSPIKER FOR TERRASSE - ZN SØM TIL TERRASSE - SINKITTY TERASSINAULA		546	2.1x50	
	FÖRZINKAD TAKSPIK - SINKSPIKER FOR TAK - ZN SØM TIL TAG - SINKITTY KATTONAULA		444	2x50	
	FÖRZINKAD GOLVSPIK - SINKSPIKER FOR GULV - ZN SØM TIL LOFT - SINKITTY LATTIANAULA		210	2x50	
	FÖRZINKAD SPIK FÖR TAKLÄKT - SINKSPIKER FOR TAKPAPPLIST - ZN SØM TIL TAGPAPPLISTER - KATTOHUOPALISTAN SINKITTY NAULA		24	2x40	
	GAVELSEGMENT - GAVLEDEL - GAVLSEGMENT - KORISTEPALA		2		
	PLANBRICKA FÖR GÄNGSTÅNG - STOPPSKIVE FOR GJENGESTANG - SKIVE TIL GEVINDSTANG - KIERRETANGON ALUSLAATTA		4	D10	
SB	BINDBJÄLKE TILL SKJUTVÄGG - SKYVEDØRSFESTE - SKYDEBESLAG TIL VÆG - LIUKUKIINNIKE SEINÄÄN		2	D6	
SL	BINDBJÄLKE TILL SKJUTVÄGG - SKYVEDØRSFESTE - SKYDEBESLAG TIL VÆG - LIUKUKIINNIKE SEINÄÄN		2		
PHA	HÖJDJUSTERING AV POST - JUSTERING AV SØYLEHØYDE - HØJDEJUSTERING AF STOLPE - TOLPAN KORKEUDEN SÄÄTÖ		1		
	FÖNSTER - VINDU - VINDUE - IKKUNA 560x1780	AK.1.100.TPSP DGP+	1		
	FÖNSTER - VINDU - VINDUE - IKKUNA 1010x1780	TAK.1.100.TPM0.e DGP+	1		
	DÖRR - DØR - DØR - OVI 1588x1957	TUK.1.100.TPVP.MM DGP+	1		

Pos	31.10.2017	Delförteckning - Liste over deler - Stykliste - Osaluettelo 1588x1957 TUK.1.100.TPVP.MM DGP+	1/1	Q	P (mm)	L (mm)
						
					 1488x1873 mm	
					 14 mm 561x1593 mm	
HS4	Skruv för golvläkt - Skruer for dørliste - Skruer til dørliste - Ovilistan asennusruuvi		5	3x30		
HS16	Skruv för dörrkarm - Skruer for dørstolpe - Skruer til dørkarm - Oven karmin ruuvi		4	5x90		
HS25	Skruv för dörrtröskel - Skruer for terskel - Skruer til dørtrin - Kynnyksen ruuvi		3	4.5x65		
MH	Gångjärn för dörr - Bolt for dørhengsel - Hanskrue til dørhengsel - Oven sarana		6	14x80		
HC	Gångjärnskaopor för dörr - Deksel over hengsle - Hængsel-dæksel - Oven saranasuoja		12			
TL4	Handtag för dörr - Dørbeslag - Dørhåndtag - Ovenpainike		1			
TL5	Sats med täckbrickor för dörrlås - Et sett av dørbeslag - Sæt af låsedæksler - Lukkokilpisarja		1			
	Cylinder - Sylindertilås - Cylinderlås - Sylinterilukko		1	30x35		
	Låsets slutstykke - Fallelåsens sluttstykke - Låsens slutstykke - Ovensalvan vastakappale		2			

Pos	10.11.2017	Delförteckning - Liste over deler - Stykliste - Osaluettelo 560x1780 AK.1.100.TPSP DGP+	1/1	Q	P (mm)	L (mm)
-----	------------	--	-----	---	-----------	-----------

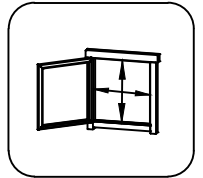
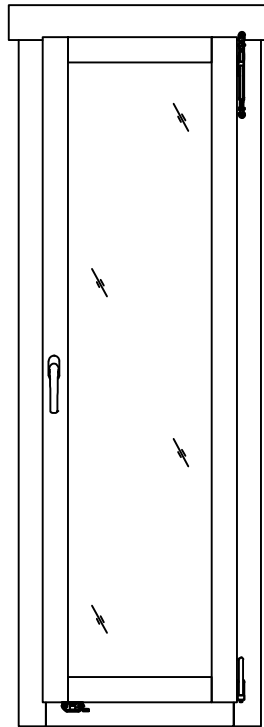

460x1684 mm

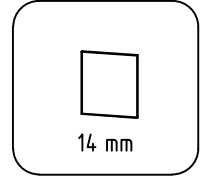

14 mm

390x1602 mm

FS2	Handtagsbeslag för fönster - Vridere til vinduer - Vindueshåndtag - Ikkunanpainikkeet		1			
-----	--	---	---	--	--	--

Pos

10.11.2017

Delförteckning - Liste over deler - Stykliste - Osaluettelo  
1010x1780 TAK.1.100.TPM0.e DGP+

1/1

Q

P  
(mm)

L  
(mm)

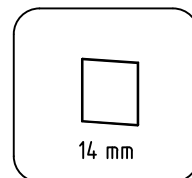
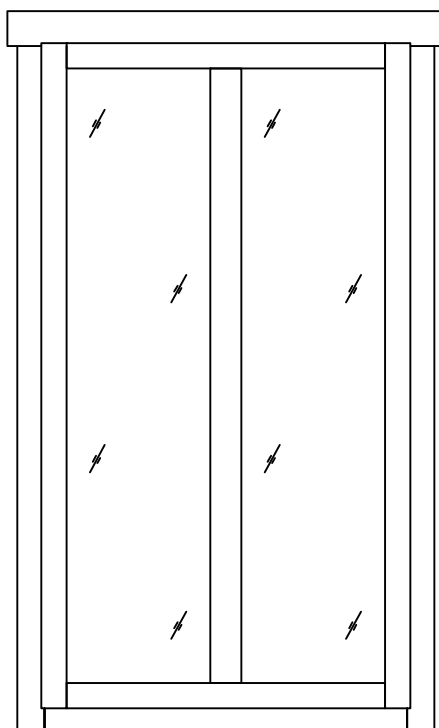

390x1602 mm