

OFFICE 21 insulated

Assembly instruction

**Important !
Wichtig !**

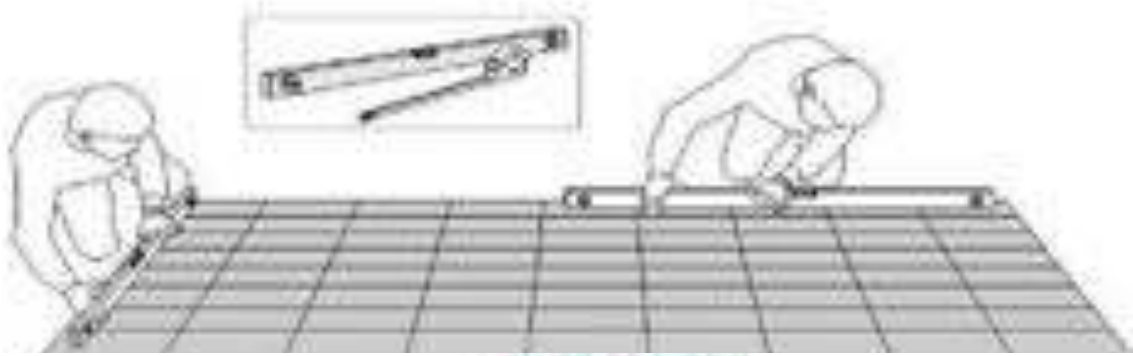

**Important !
Wichtig !**

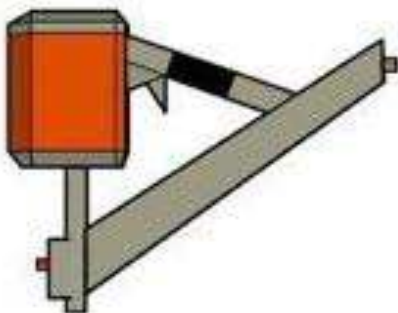

OFFICE 21 insulated Assembly instruction

1/28

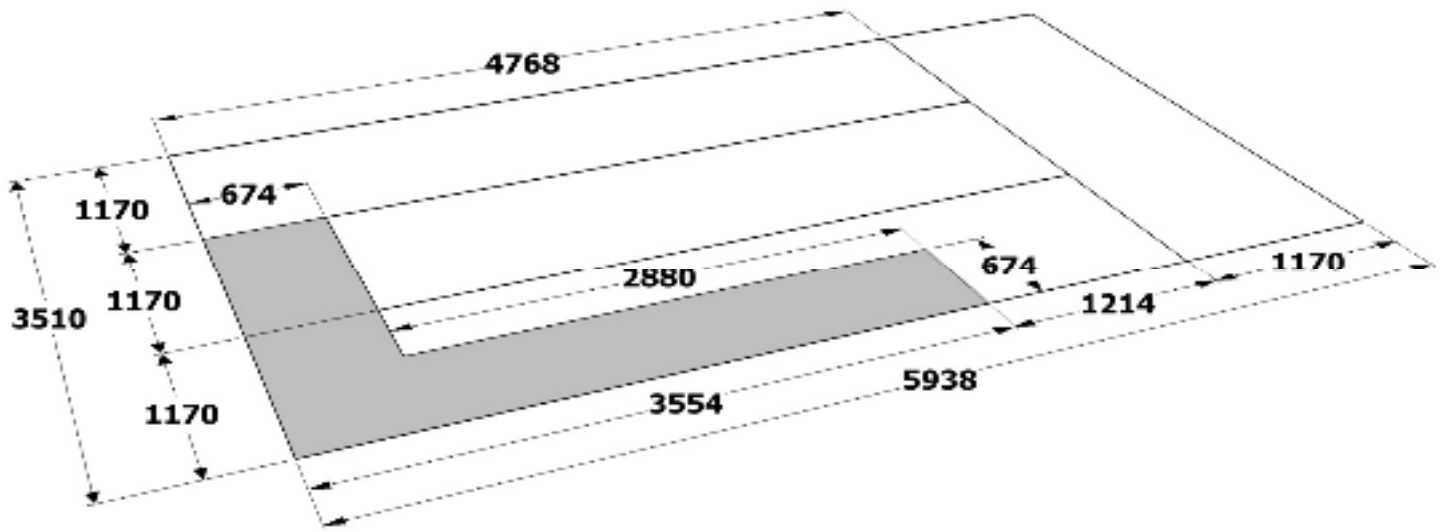

main base dimensions

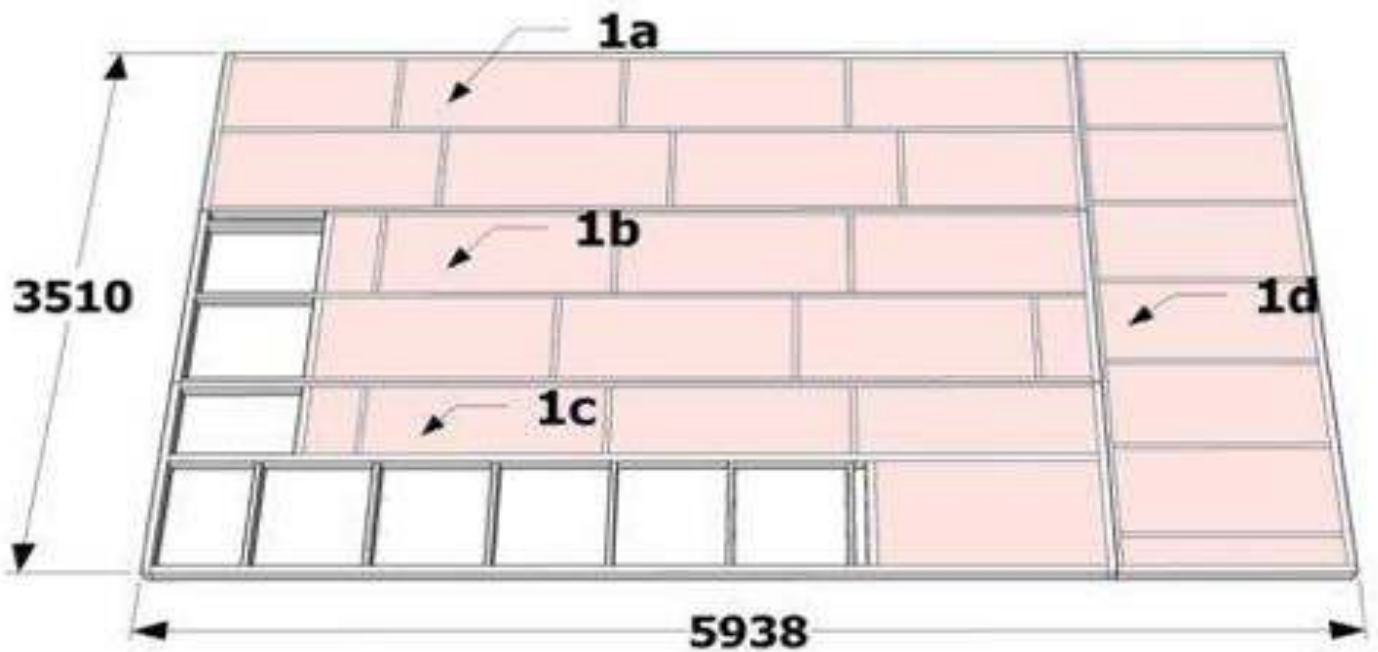

floor elements layout

OFFICE 21 insulated Assembly instruction

2/28

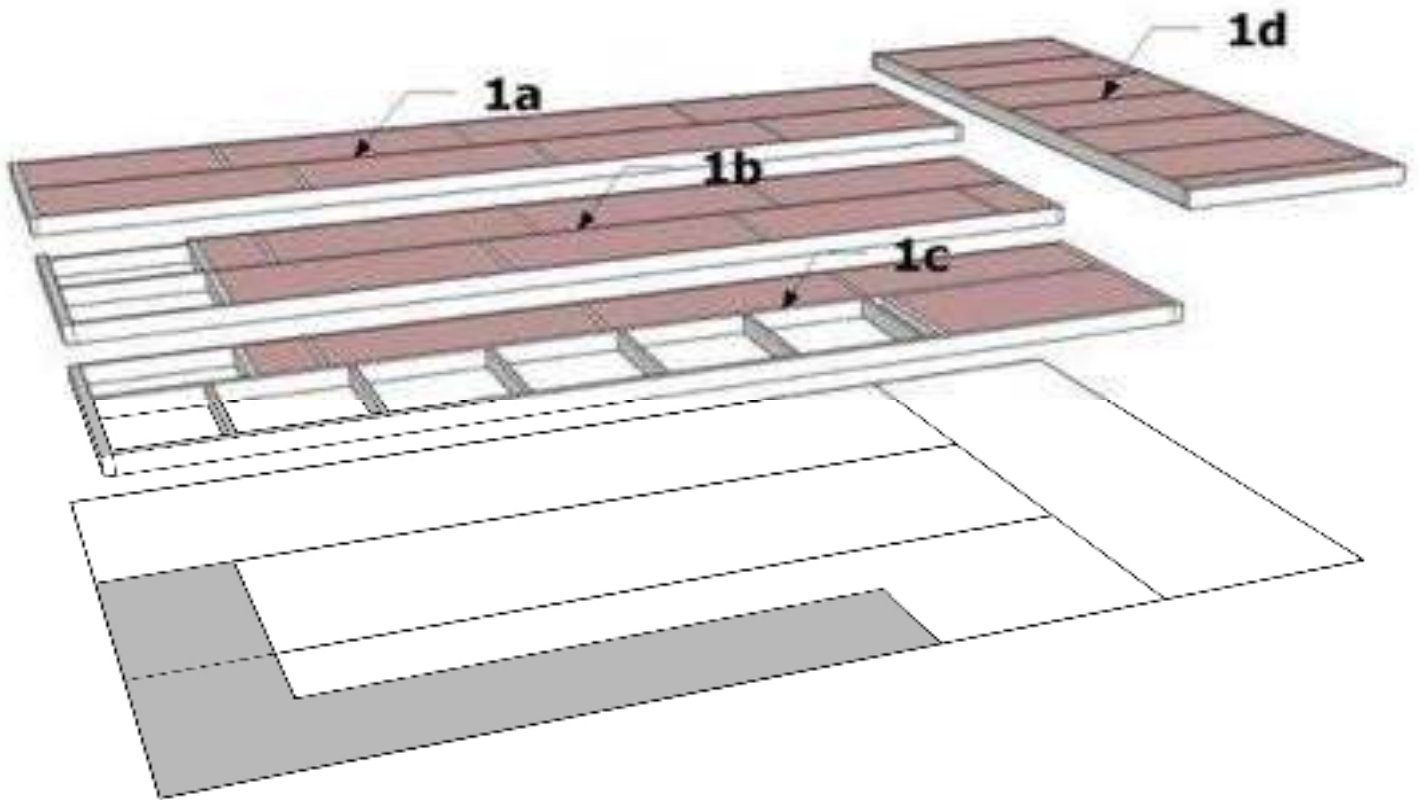

1a + **1b** + **1c** + **1d** **36** **4 x 60**

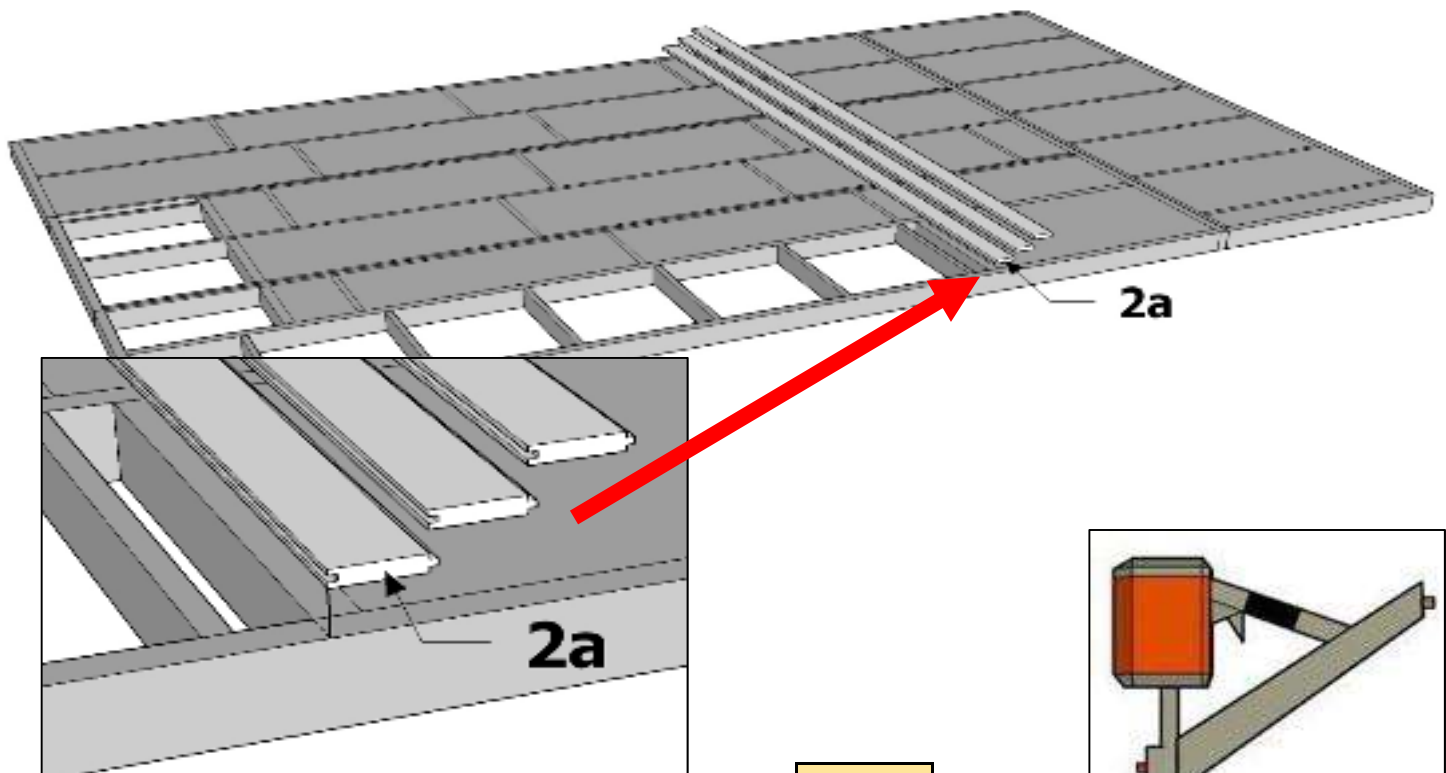

+ **2a**

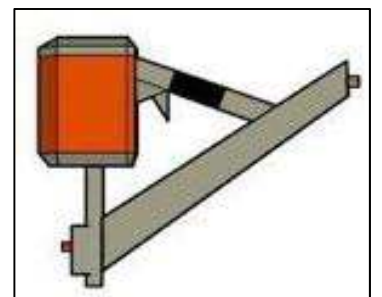

nail gun

OFFICE 21 insulated Assembly instruction

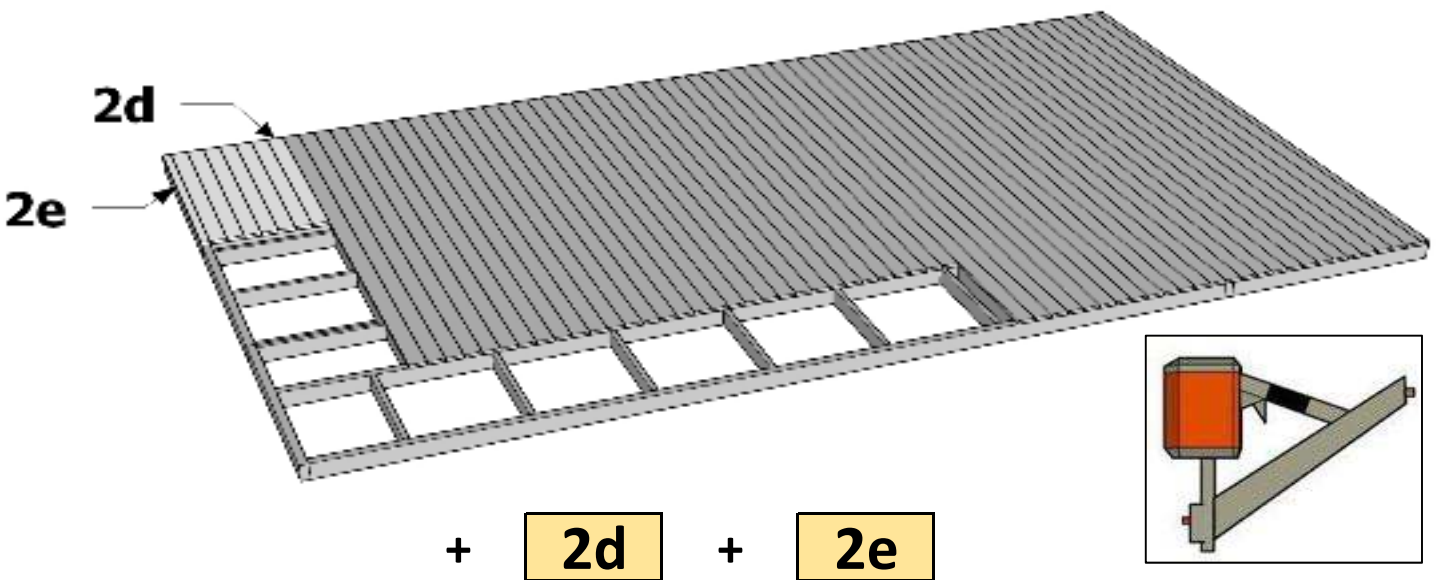
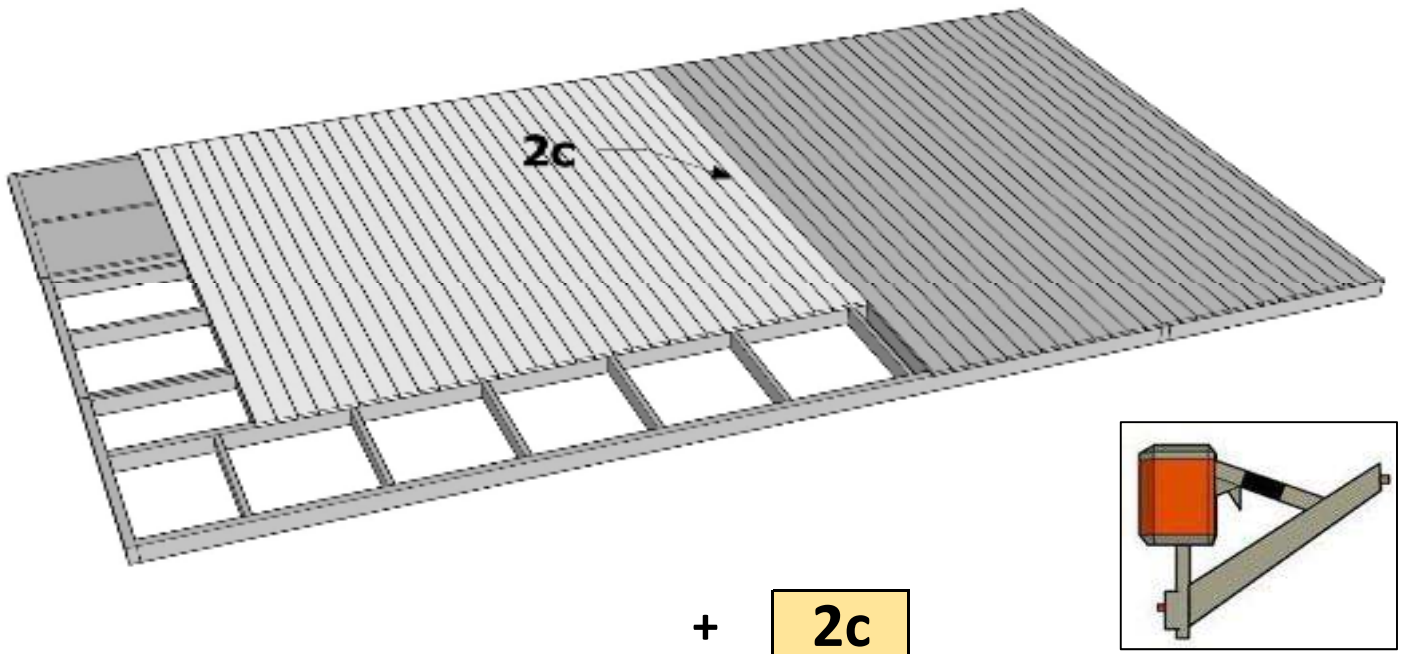
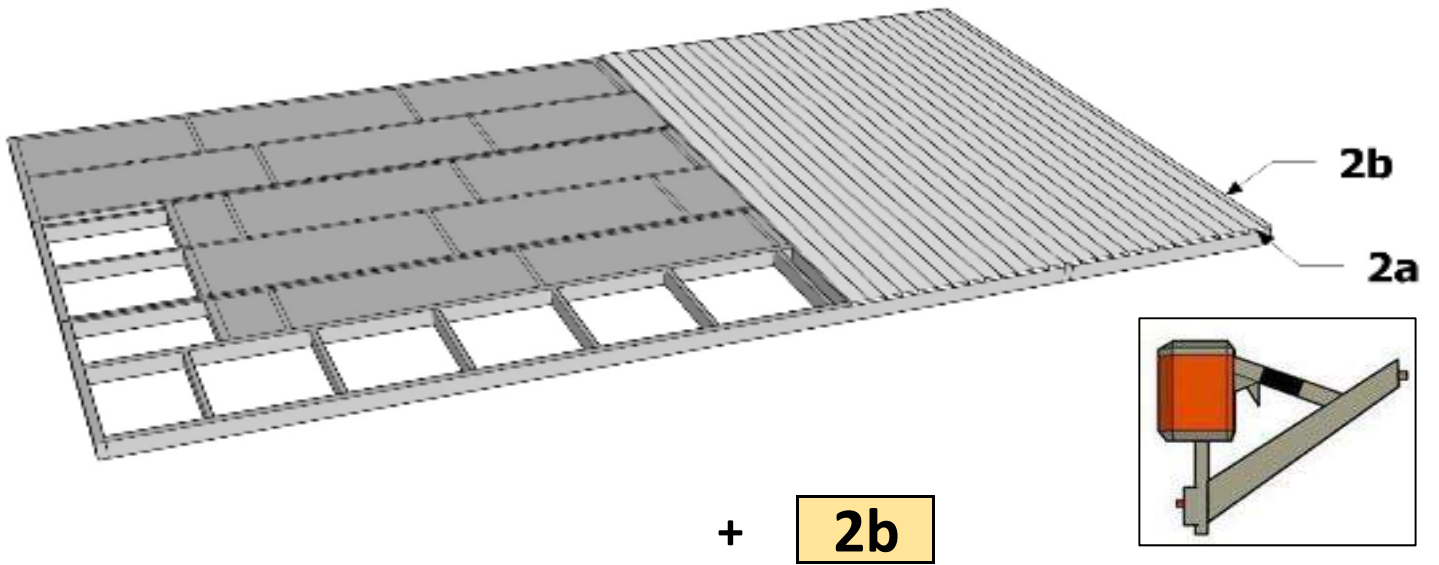

OFFICE 21 insulated Assembly instruction

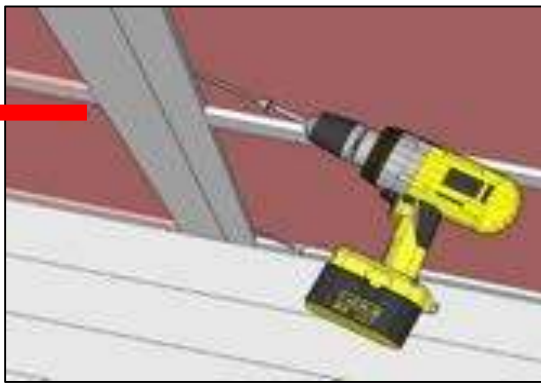
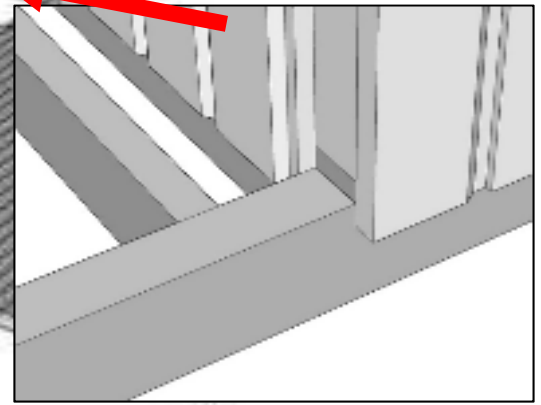
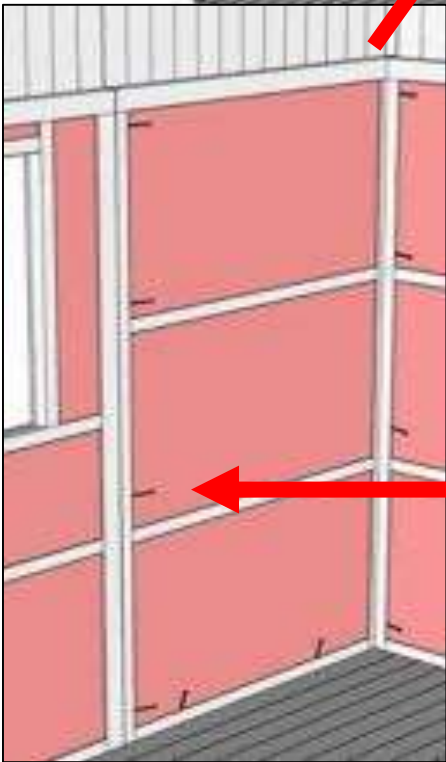
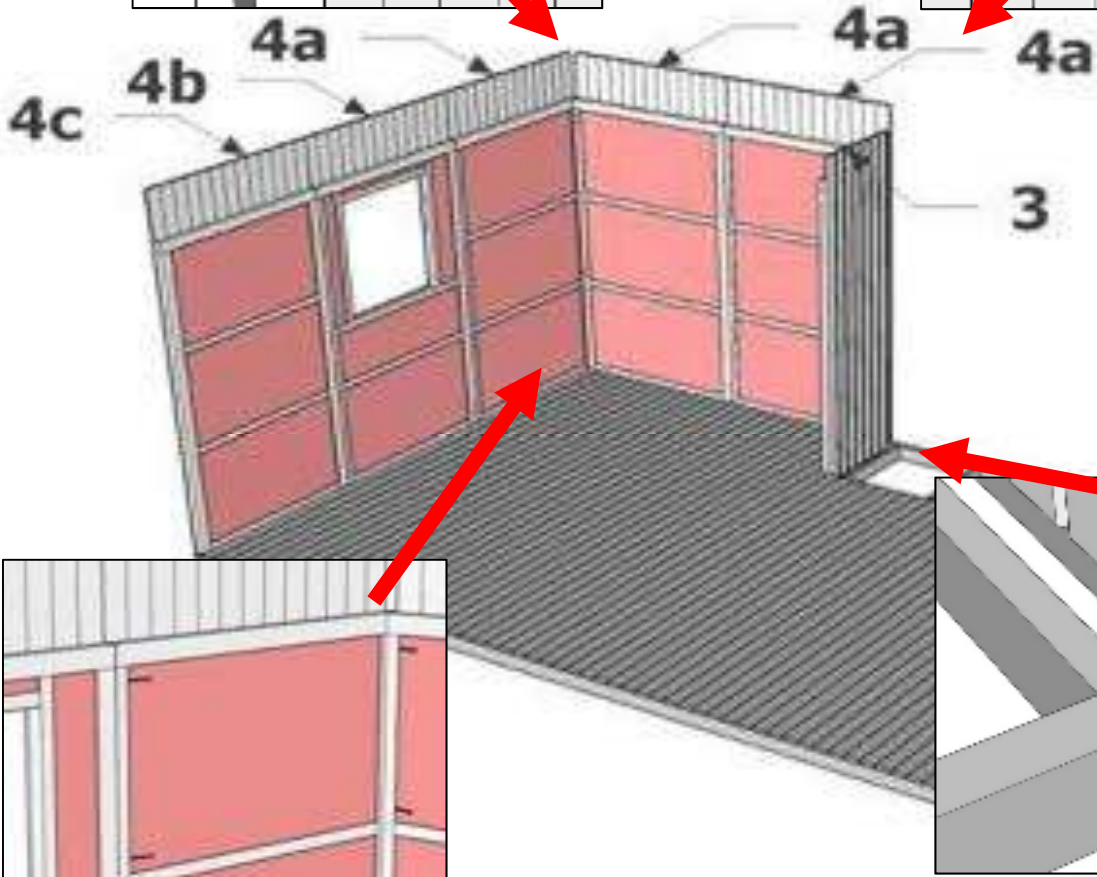
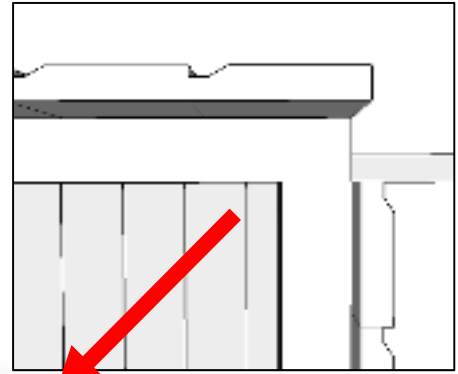
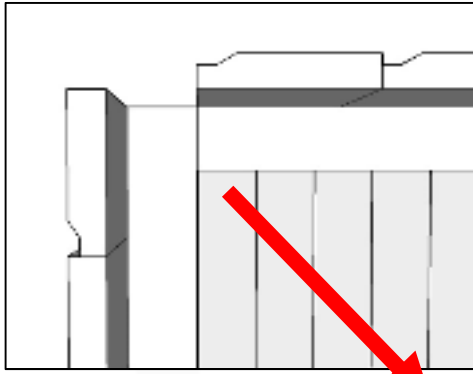

4a + 3 + 4a + 4a 25 4,5 x 80

+ 4b + 4c

4a 3 4a 4a 4b 4c + base 12 4,5 x 80

OFFICE 21 insulated Assembly instruction

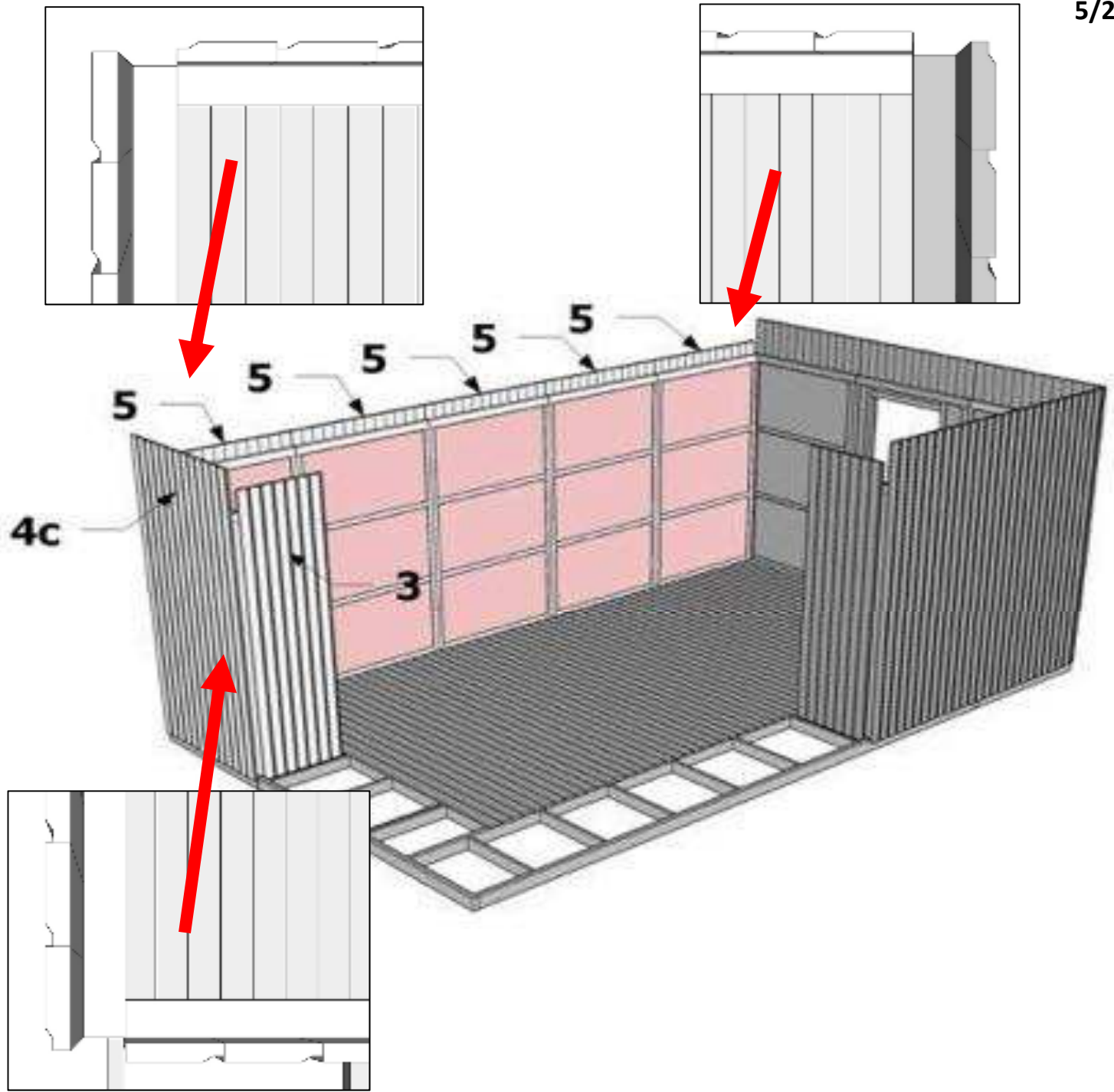

5	+	5	+	5	+	5
	+	5	+	4c	+	3
5	5	5	5	5	4c	3
					+	base

35	4,5 x 80
----	----------

14	4,5 x 80
----	----------

OFFICE 21 insulated Assembly instruction

6/28

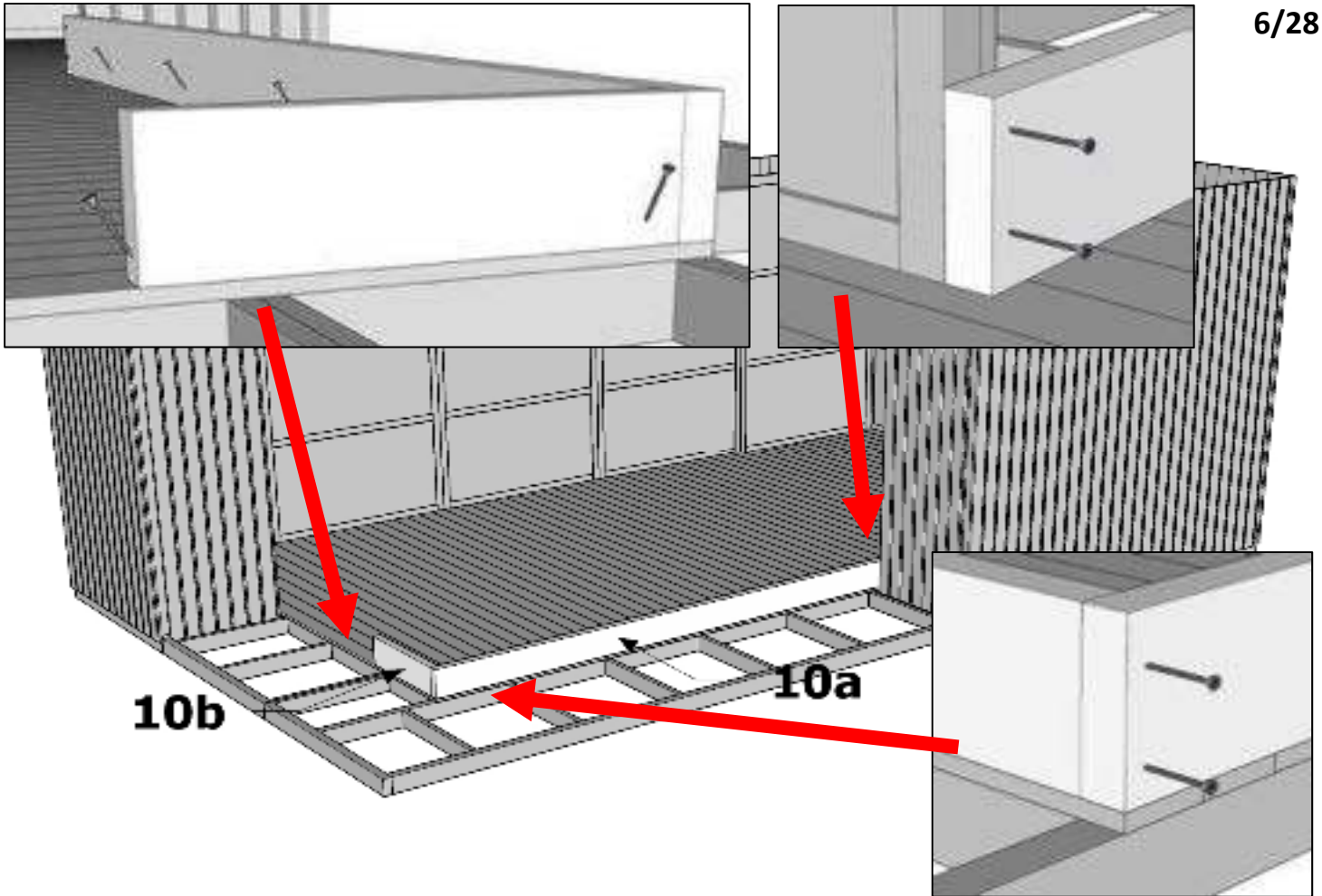

+ 10a + 10b

12	4,5 x 80
----	----------

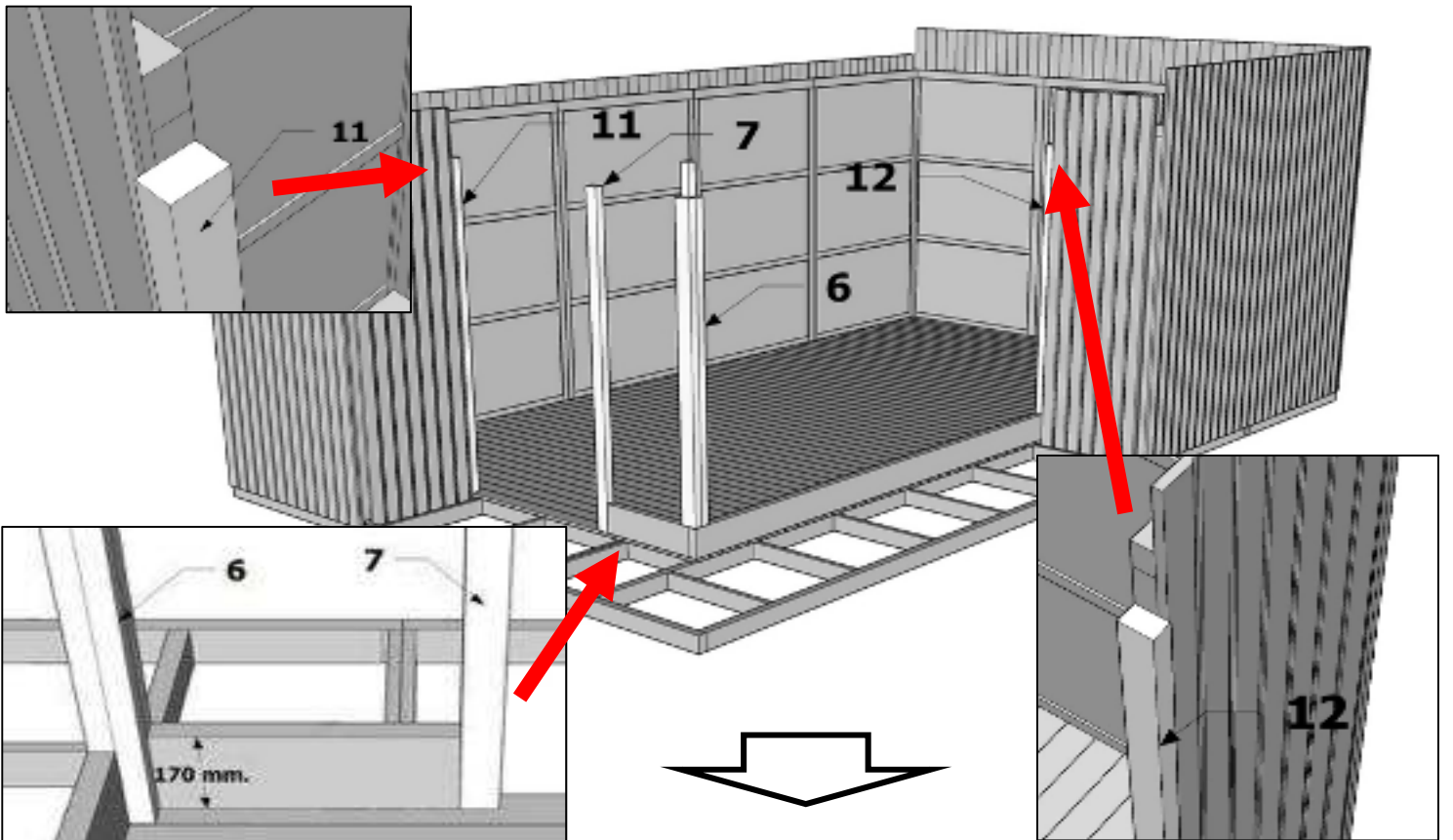

OFFICE 21 insulated Assembly instruction

7/28

11 + **12** + **6** + **7** **14** 4,5 x 80

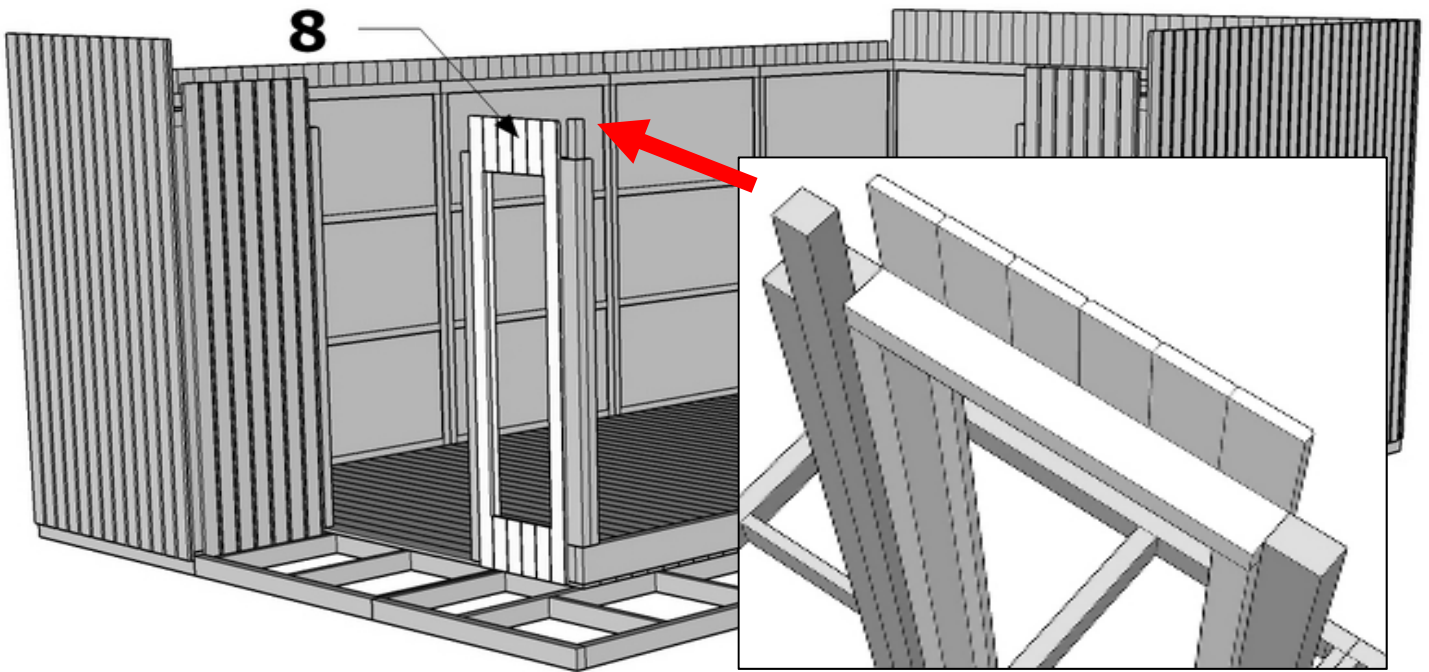

+ **8** **8** 4,5 x 80

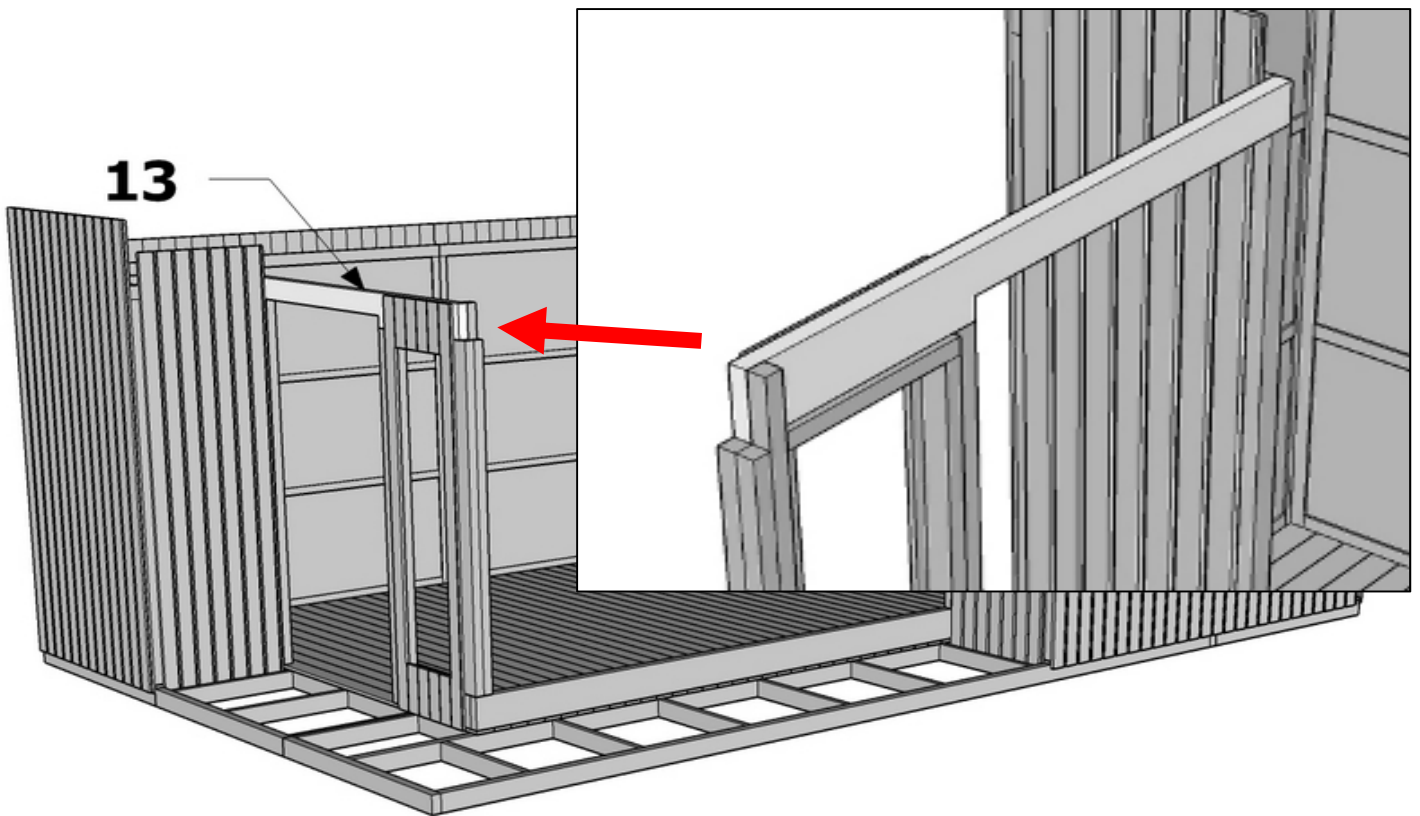

+ **13** **6** 4,5 x 80

OFFICE 21 insulated Assembly instruction

8/28

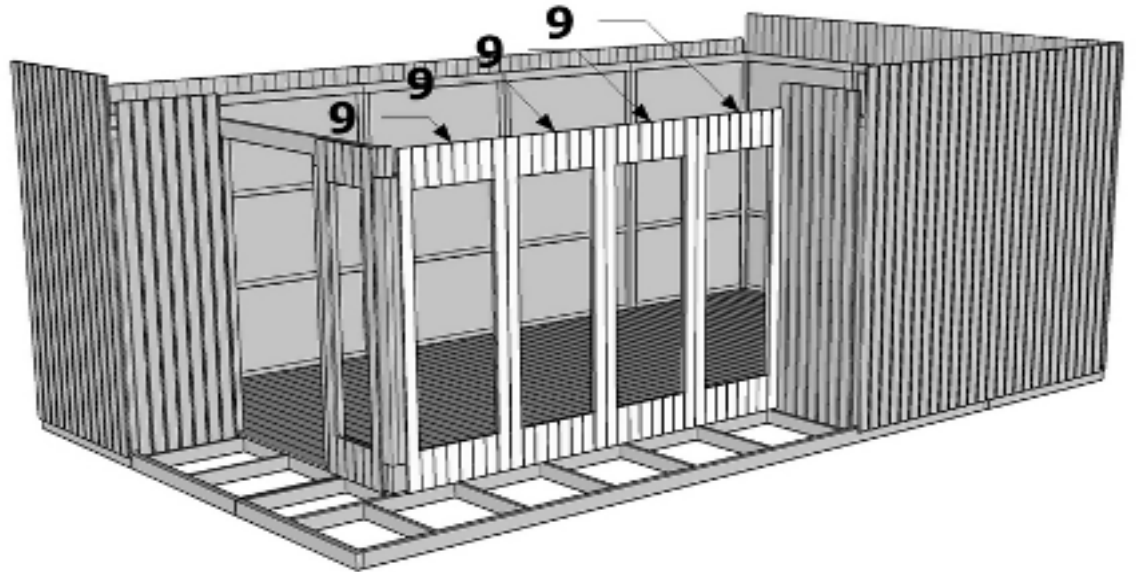
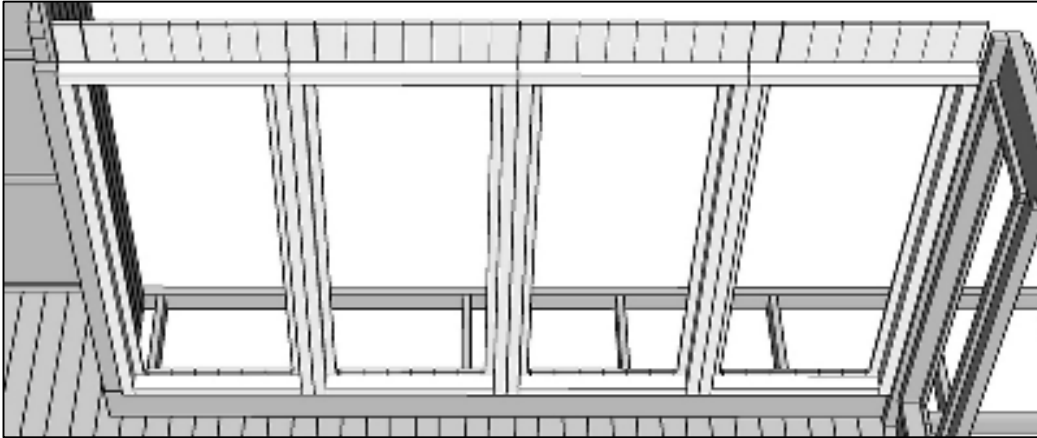

+

9

28

4,5 x 80

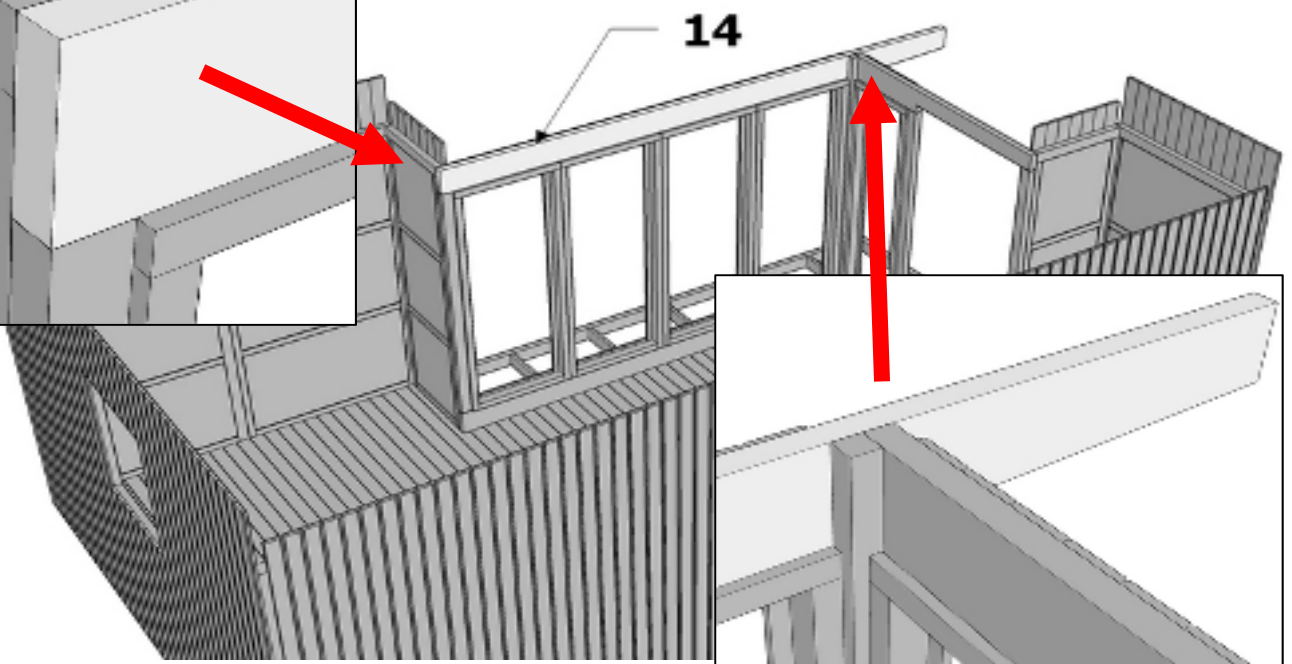
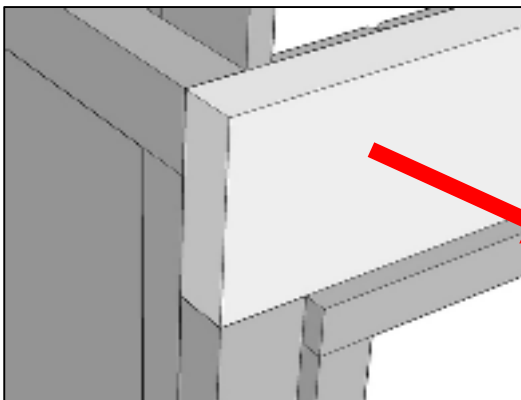

+

14

12

4,5 x 80

OFFICE 21 insulated Assembly instruction

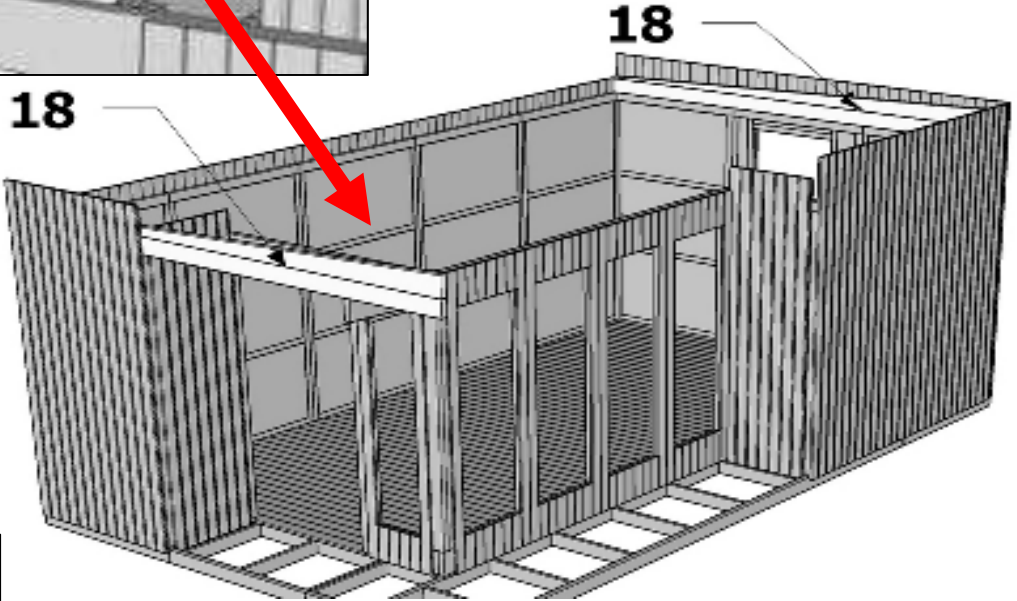
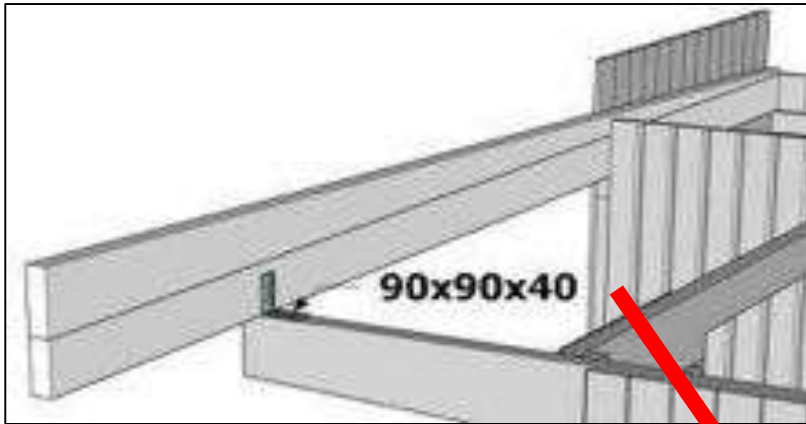

+ **18**

12	5 x 120
1	90x90x40
10	3,5 x 40

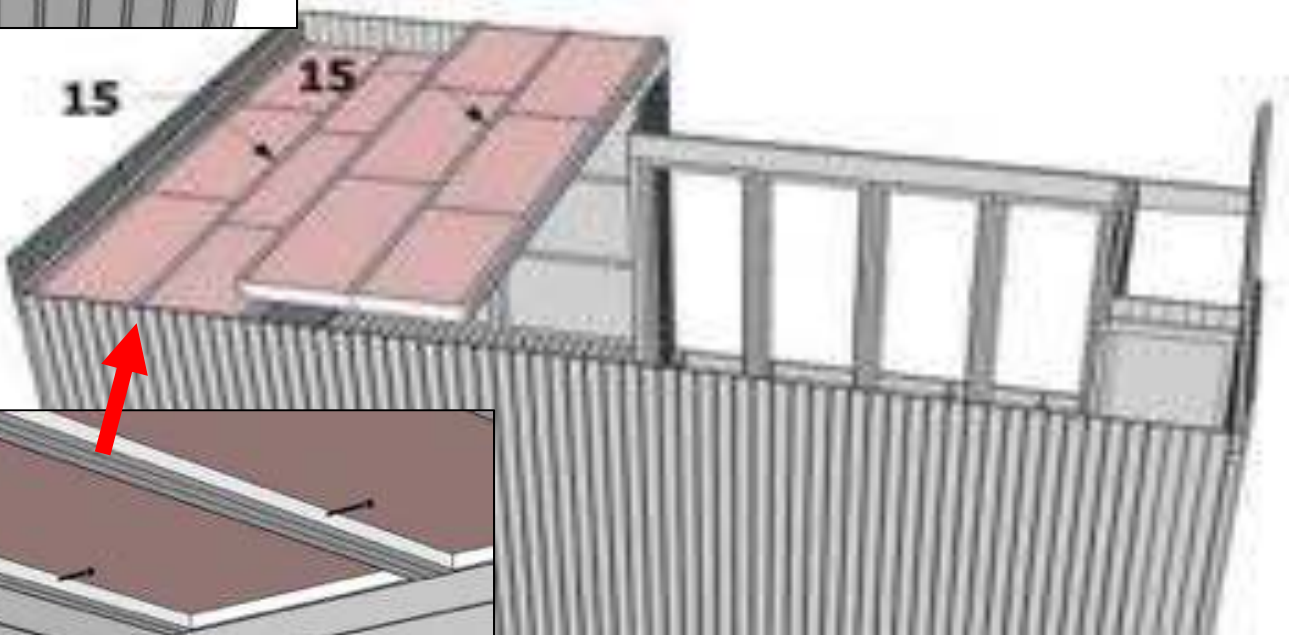
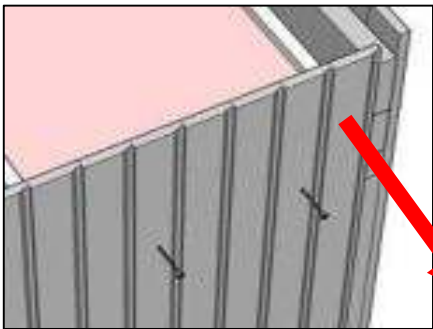

+ **15**

22	4 x 60
----	--------

OFFICE 21 insulated Assembly instruction

10/28

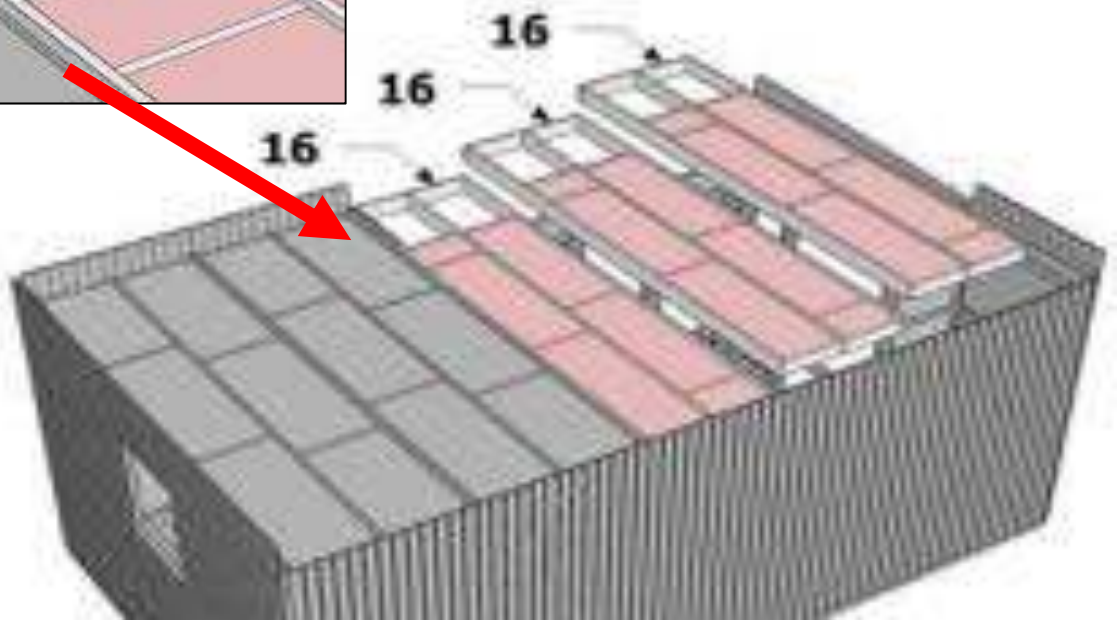
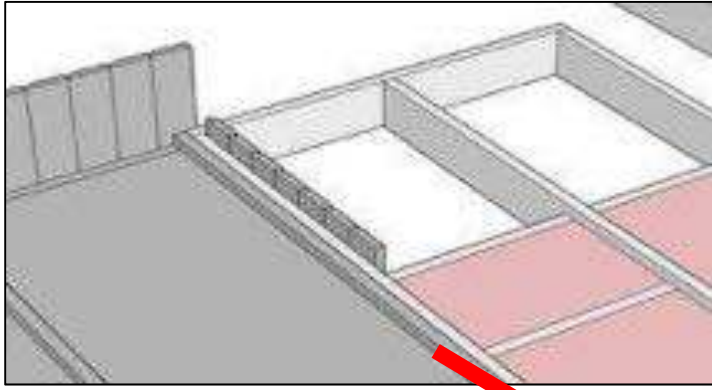

+

16

30

4 x 60

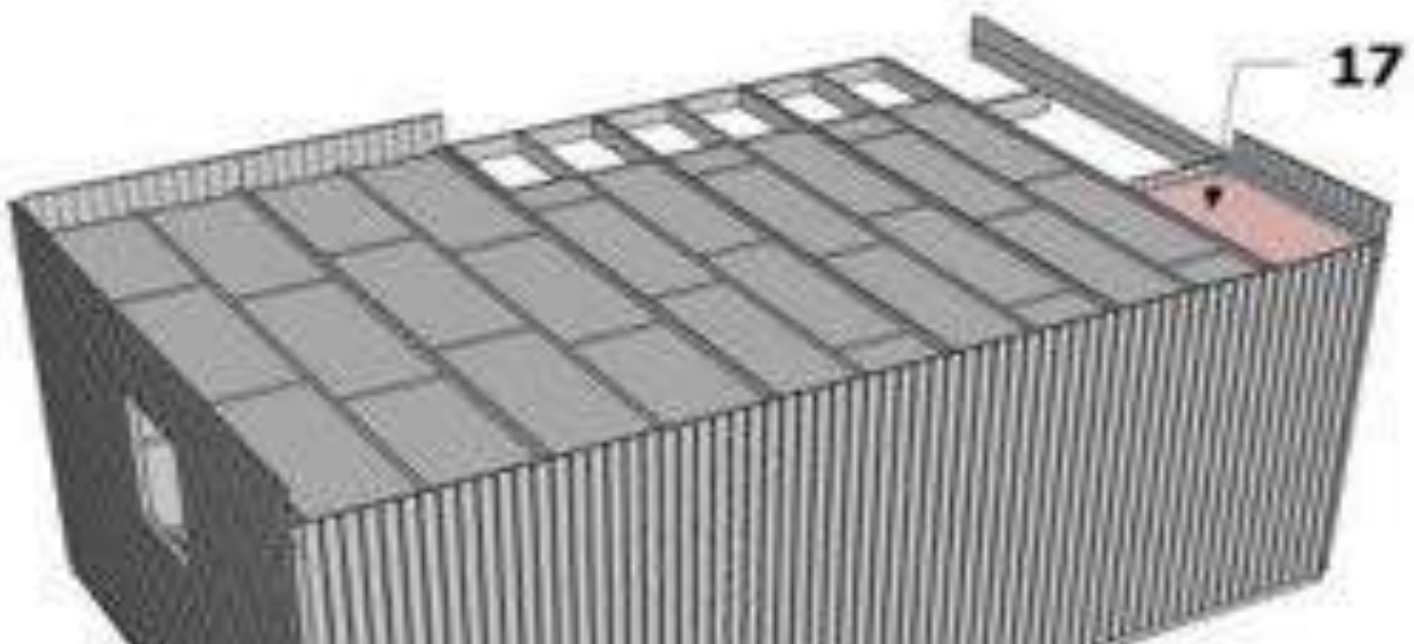

+

17

14

4 x 60

OFFICE 21 insulated Assembly instruction

11/28

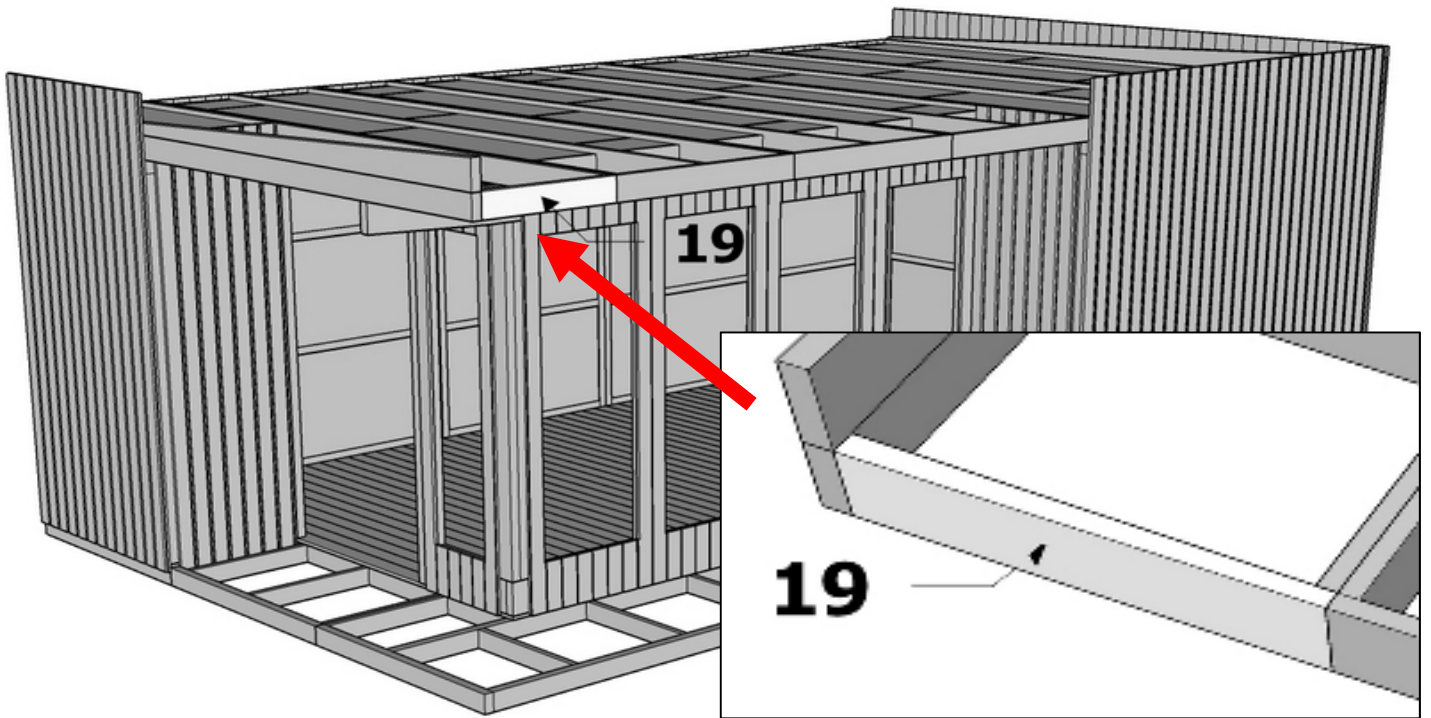

+ **19**

4	4,5 x 80
---	----------

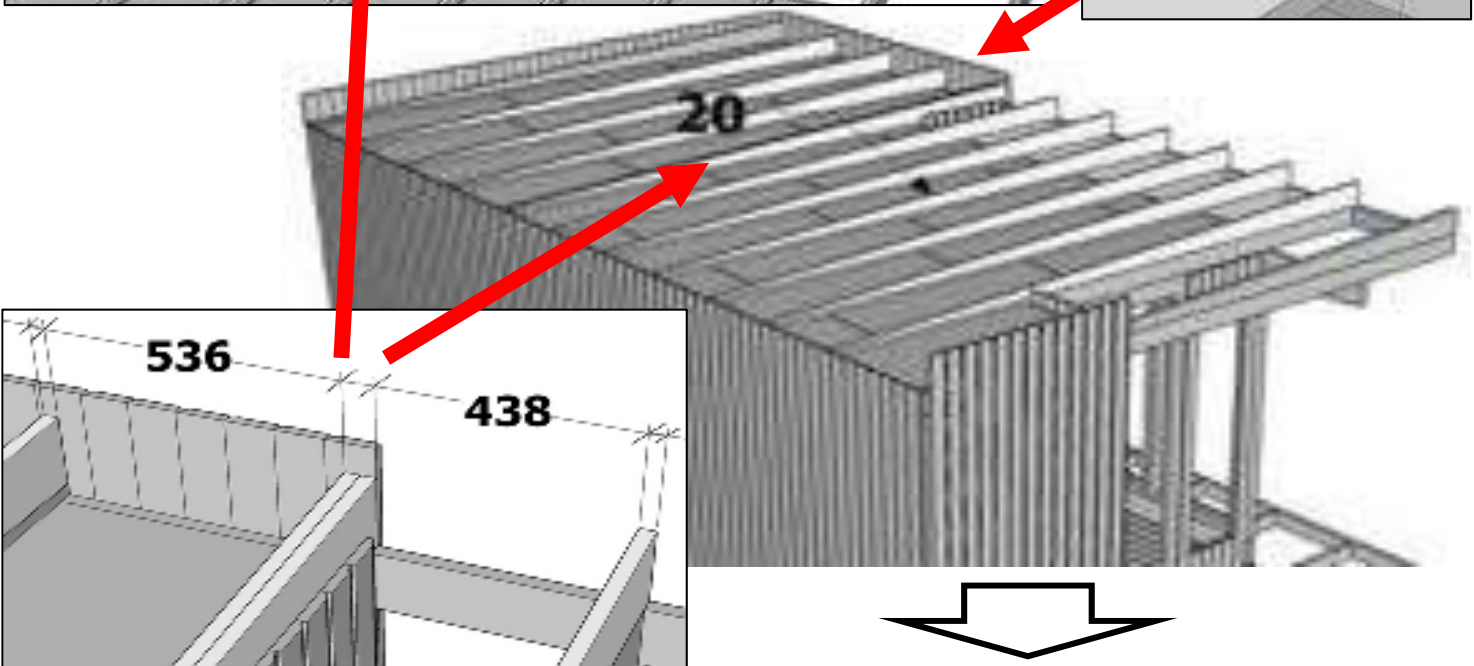
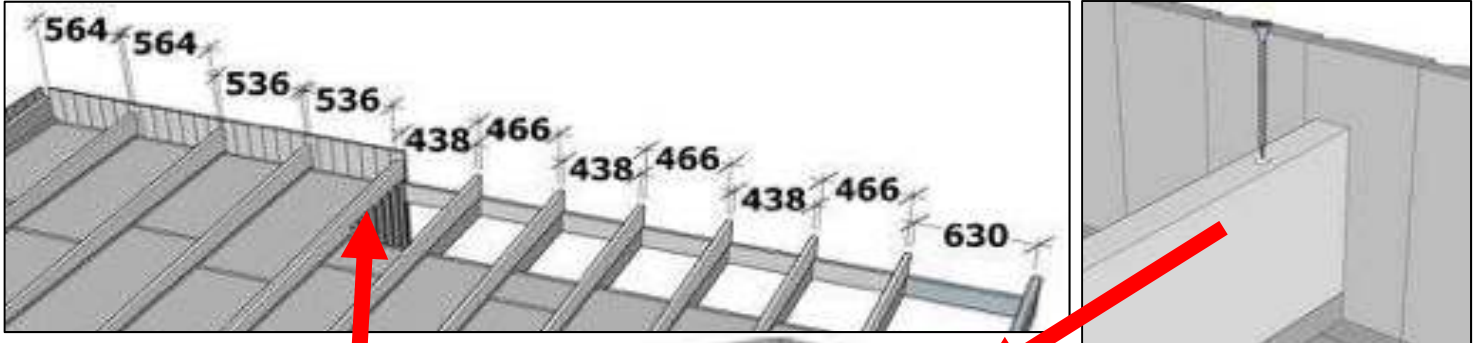

OFFICE 21 insulated Assembly instruction

12/28

+ **20**

33	4,5 x 80
33	5 x 120

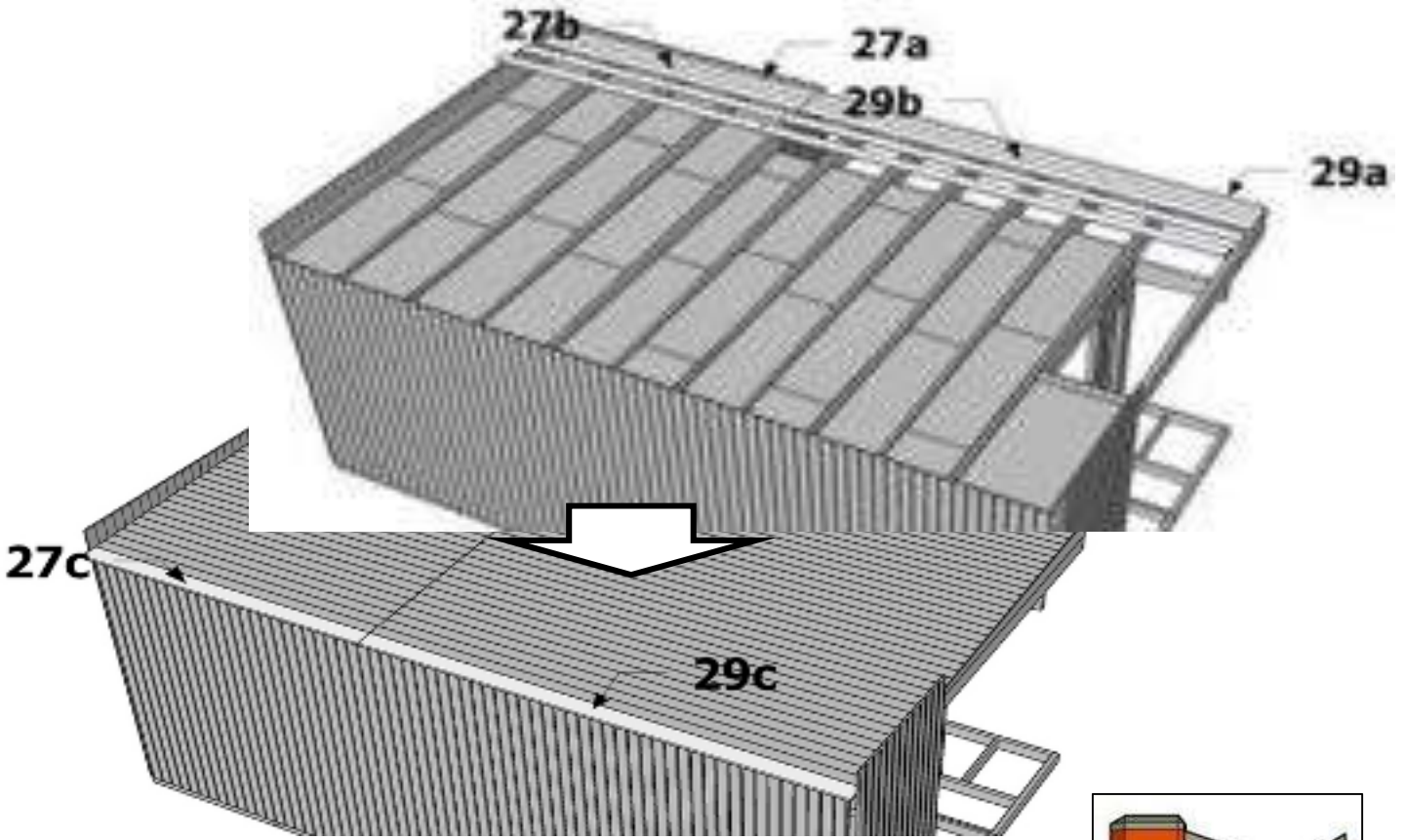

+ **27a** + **29a** + **27b**
 + **29b** + **27c** + **29c**

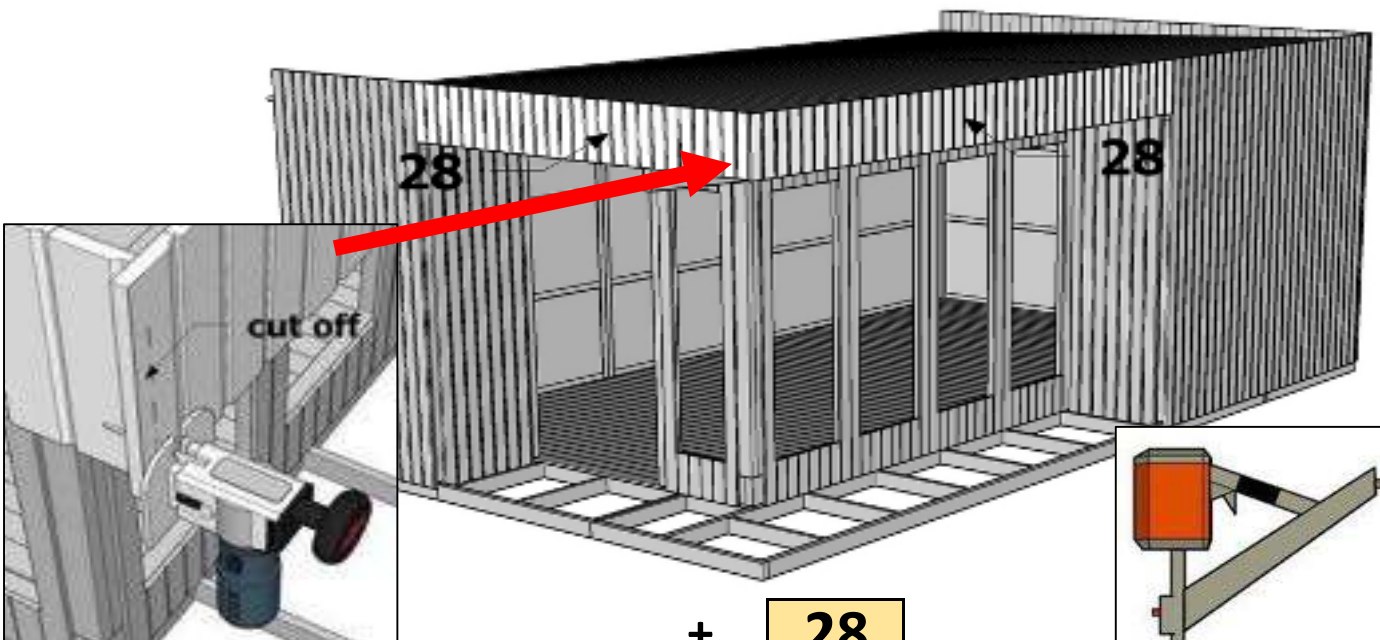
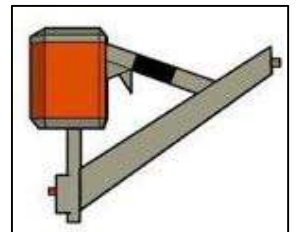

+ **28**

OFFICE 21 insulated Assembly instruction

13/28

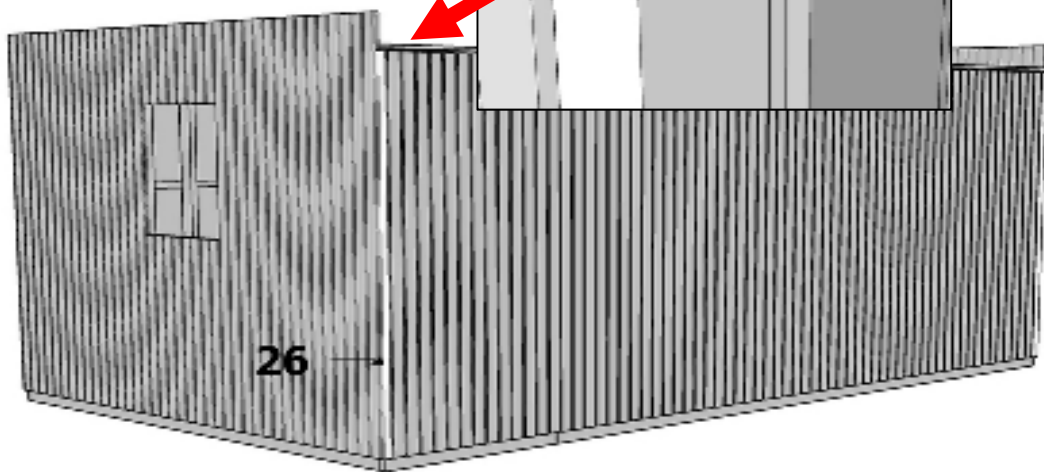
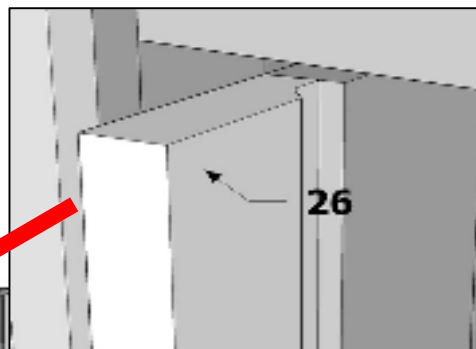
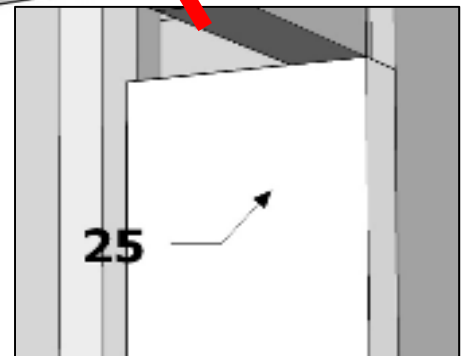
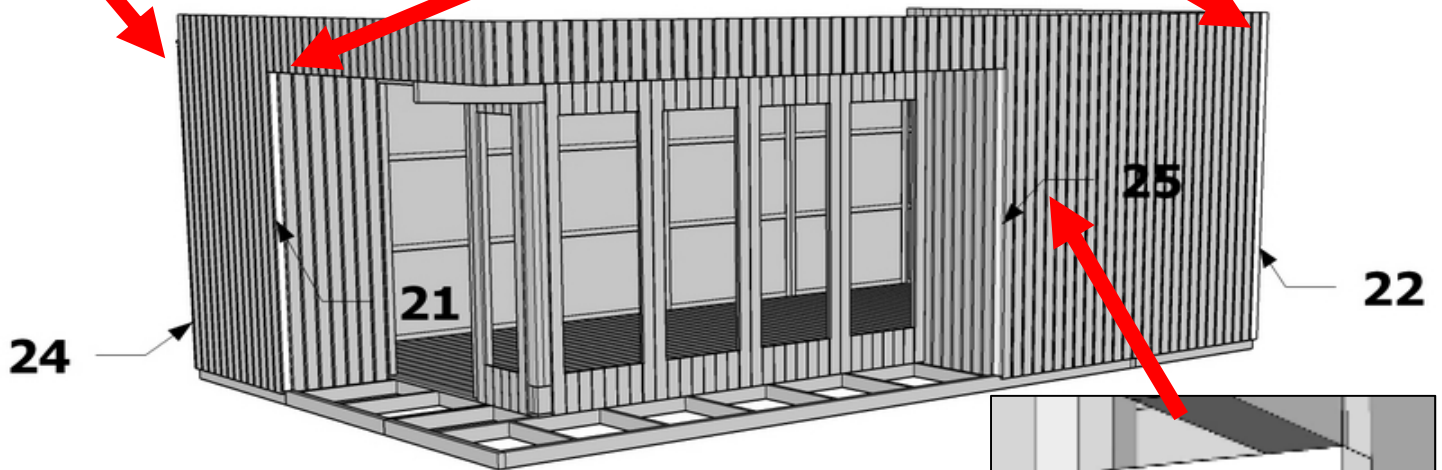
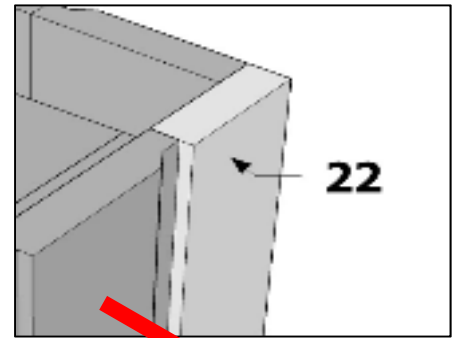
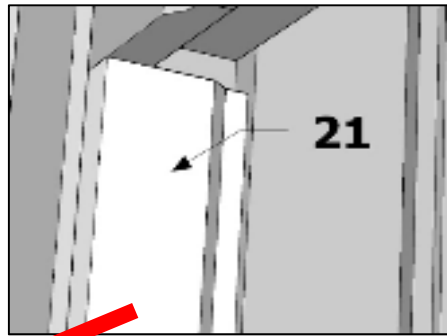
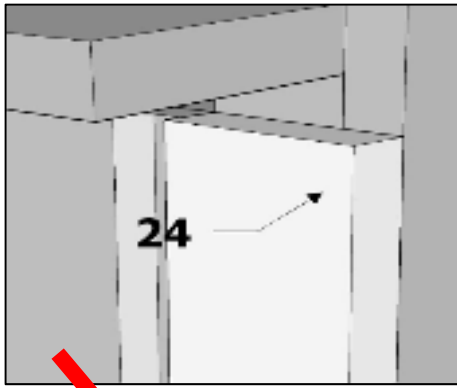

21 + **25** + **22** + **24**
+ **26**

40 | 3,5 x 40

OFFICE 21 insulated Assembly instruction

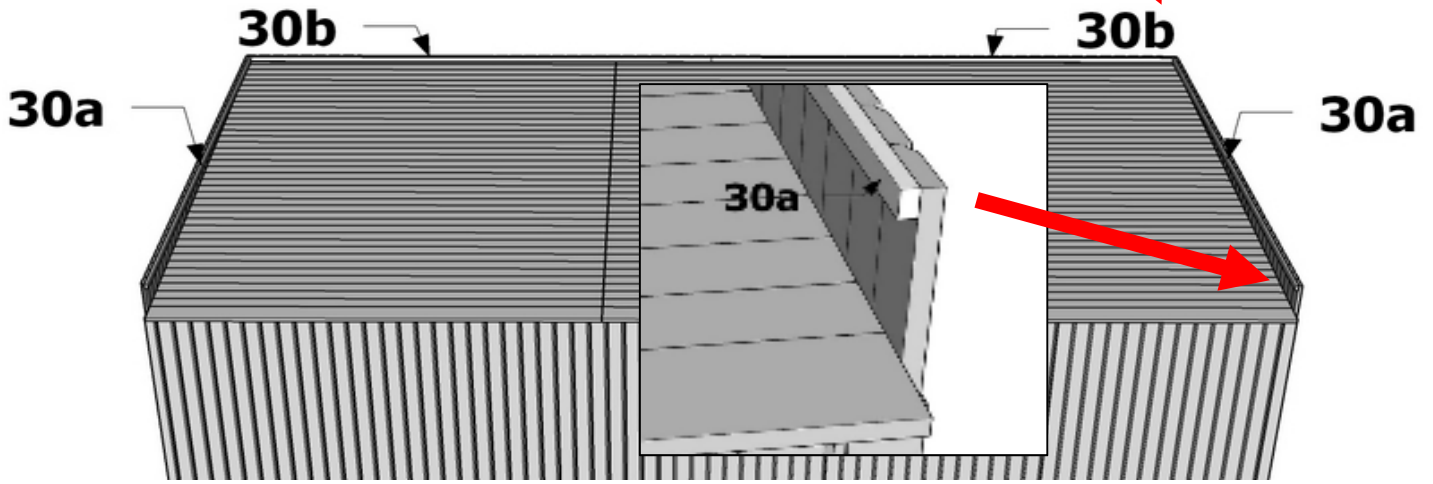
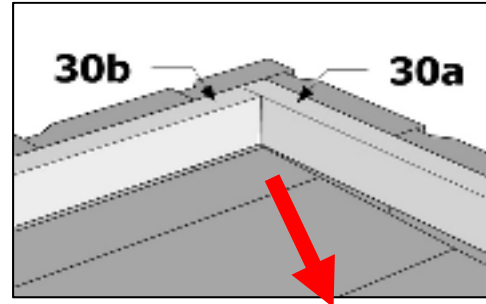

 + 30a + 30b

30	3 x 30
----	--------

In this phase You should install the roofing

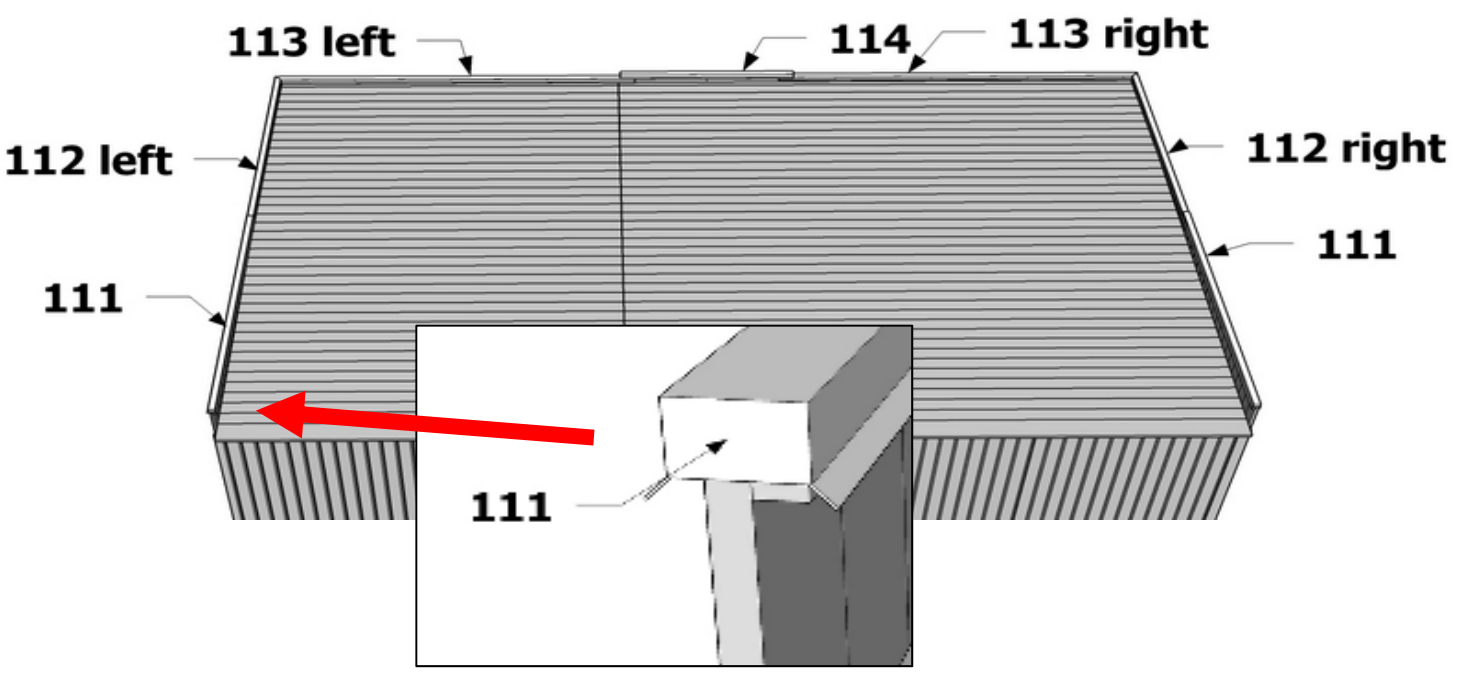

113r + 113l + 114 + 112l

22	special
----	---------

+ 111 + 112r + 111

OFFICE 21 insulated Assembly instruction

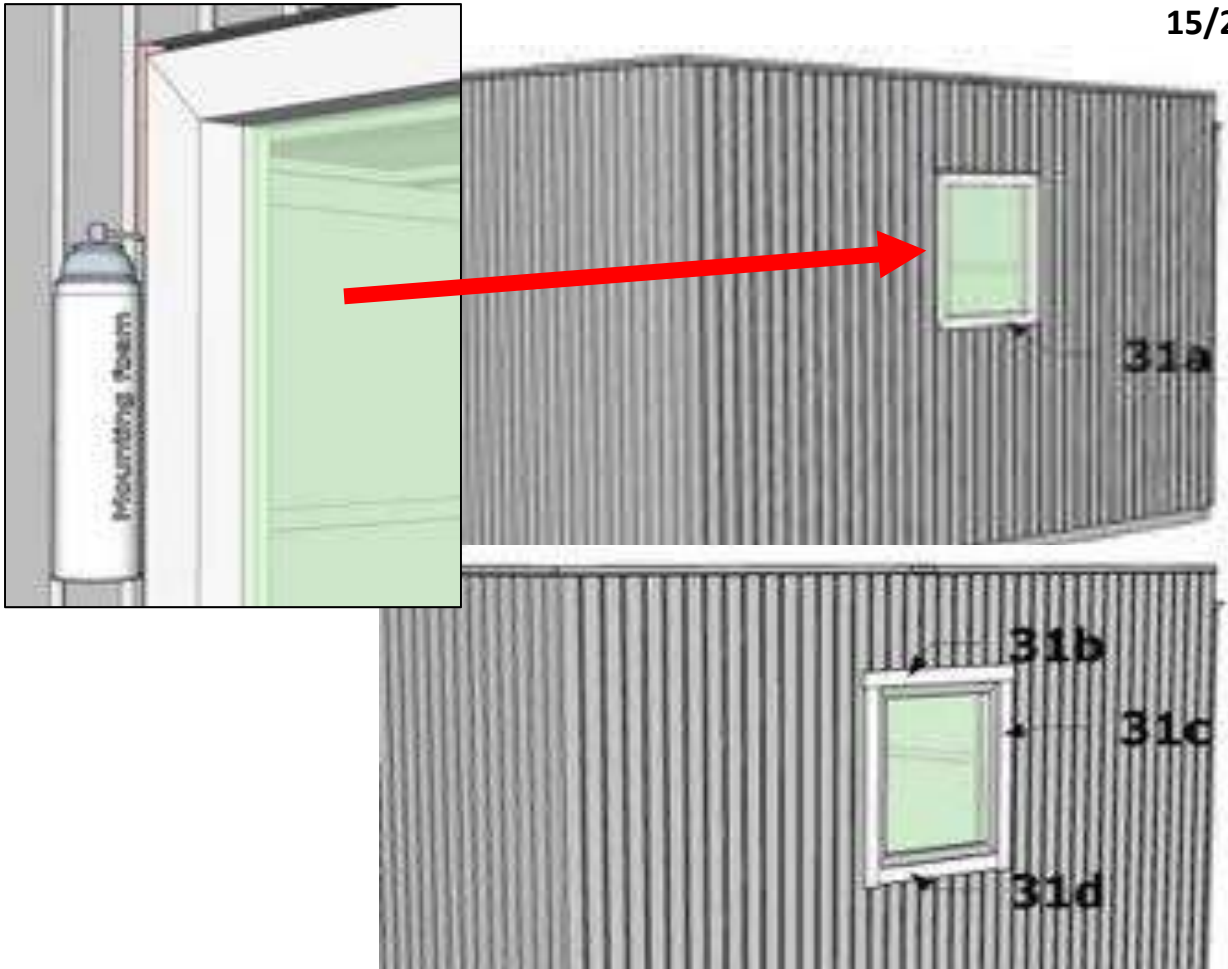

+ **31b** + **31c** + **31d**

24	3,5 x 40
----	----------



45 + **46** + **47** + **48**
+ **49** + **44** + **43**

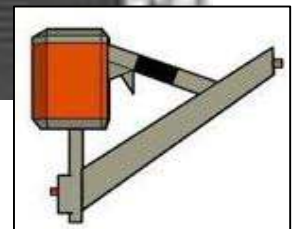

OFFICE 21 insulated Assembly instruction

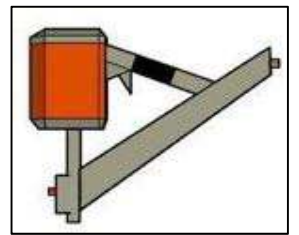
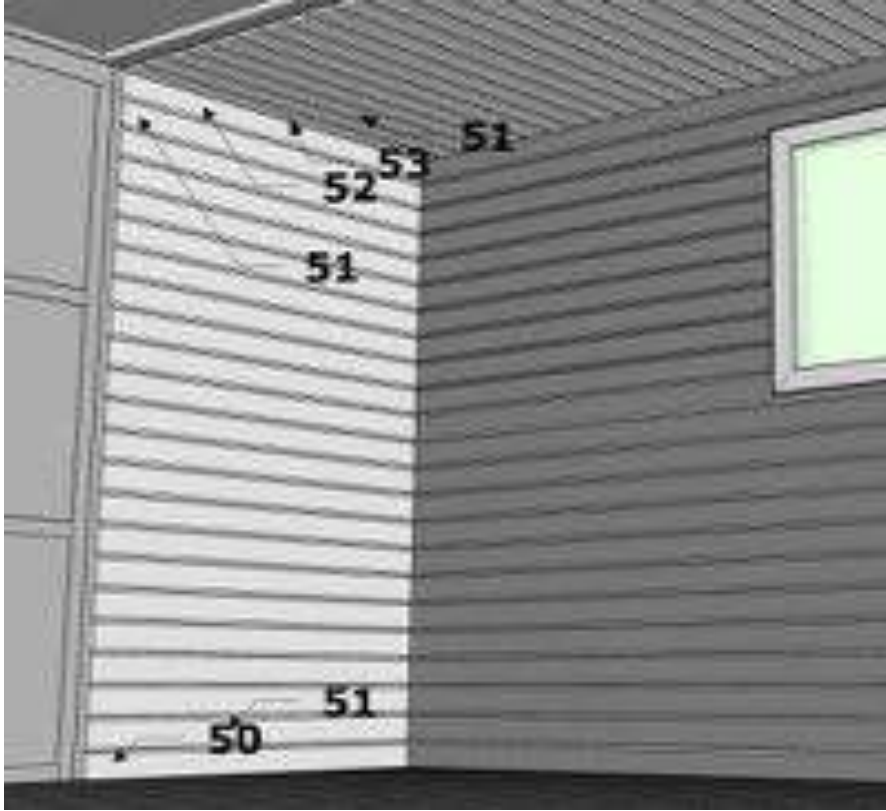
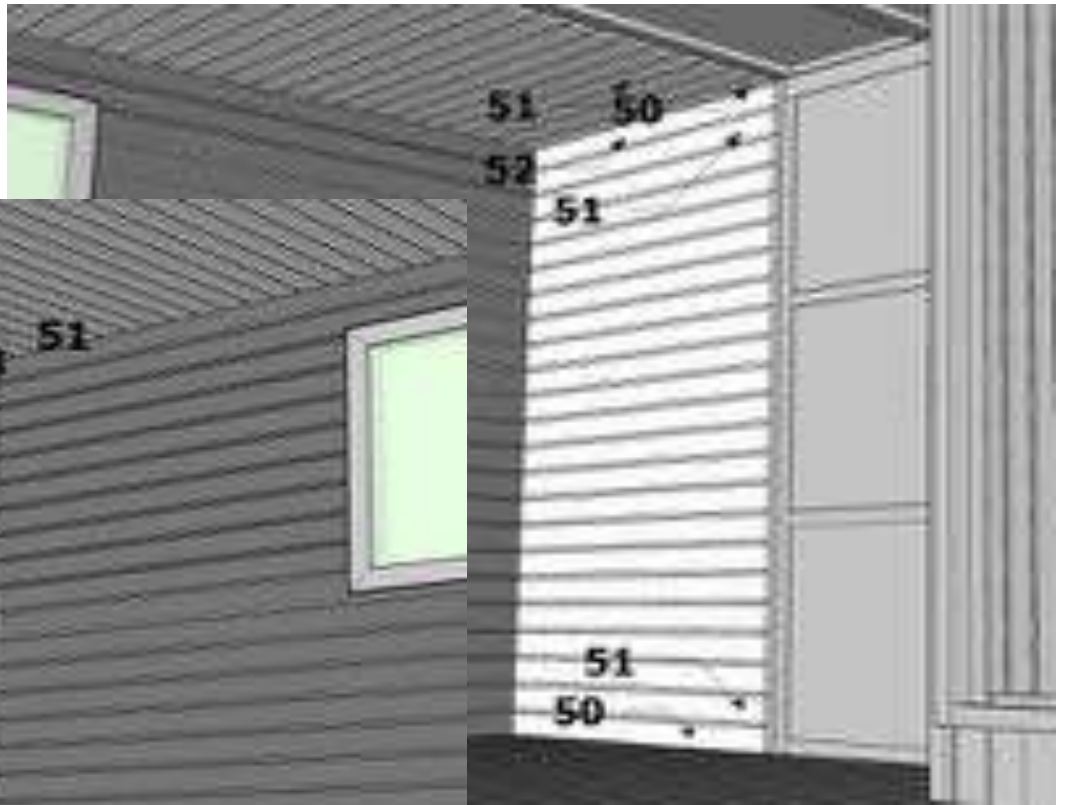

50 + **51** + **52** + **53**



OFFICE 21 insulated Assembly instruction

17/28

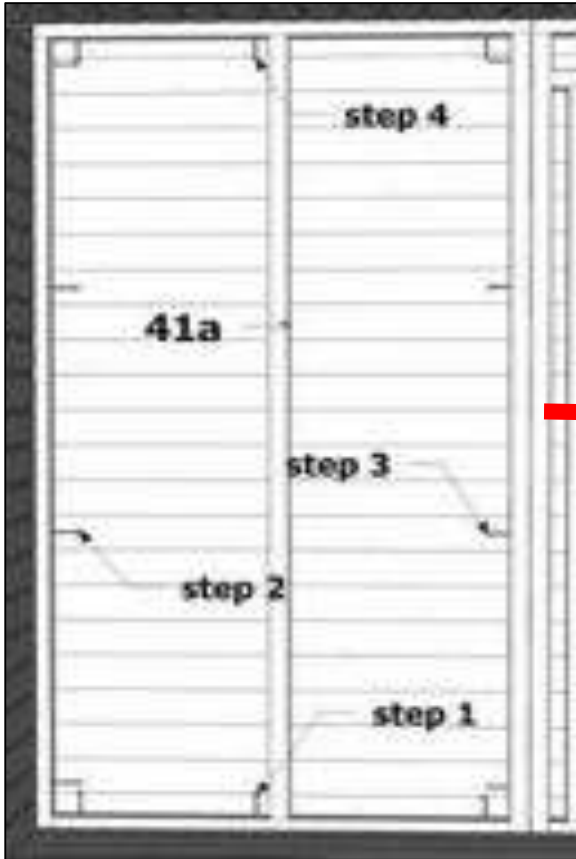

+ **41a** + **41b** + **41a**

32	4,5 x 80
----	----------



54 + **55** + **56** + **57**

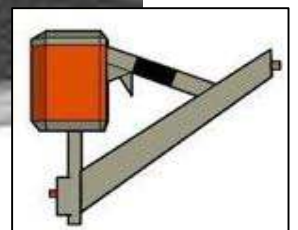

OFFICE 21 insulated Assembly instruction

18/28

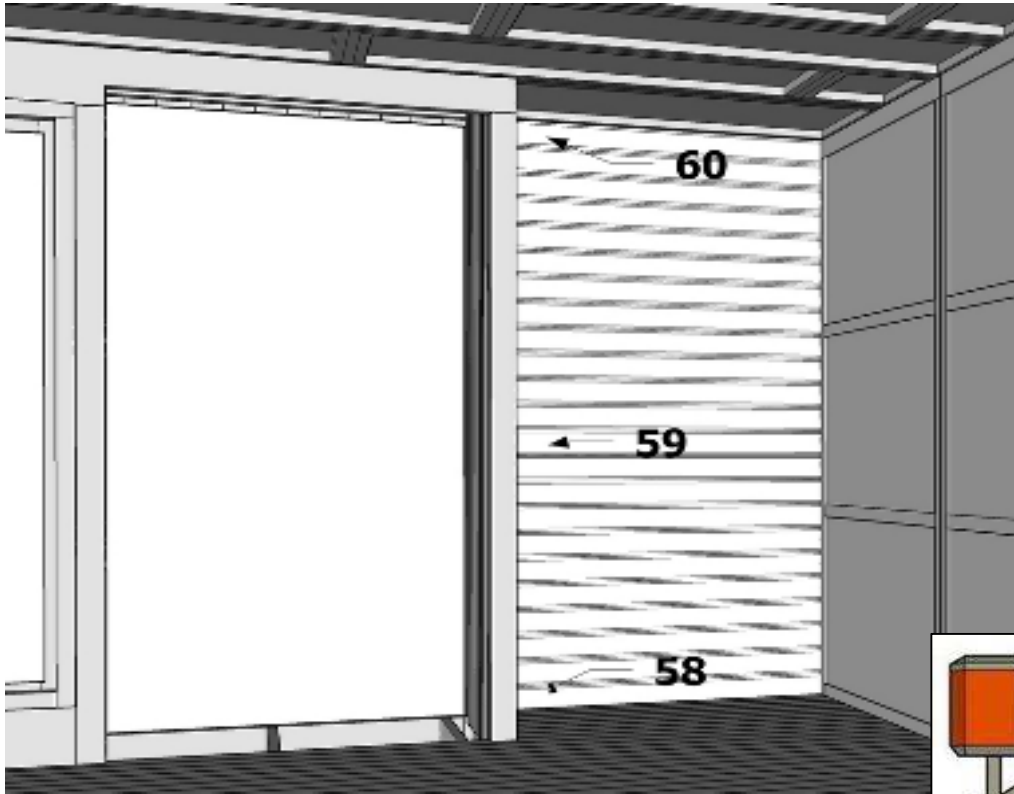

+ **58** + **59** + **60**

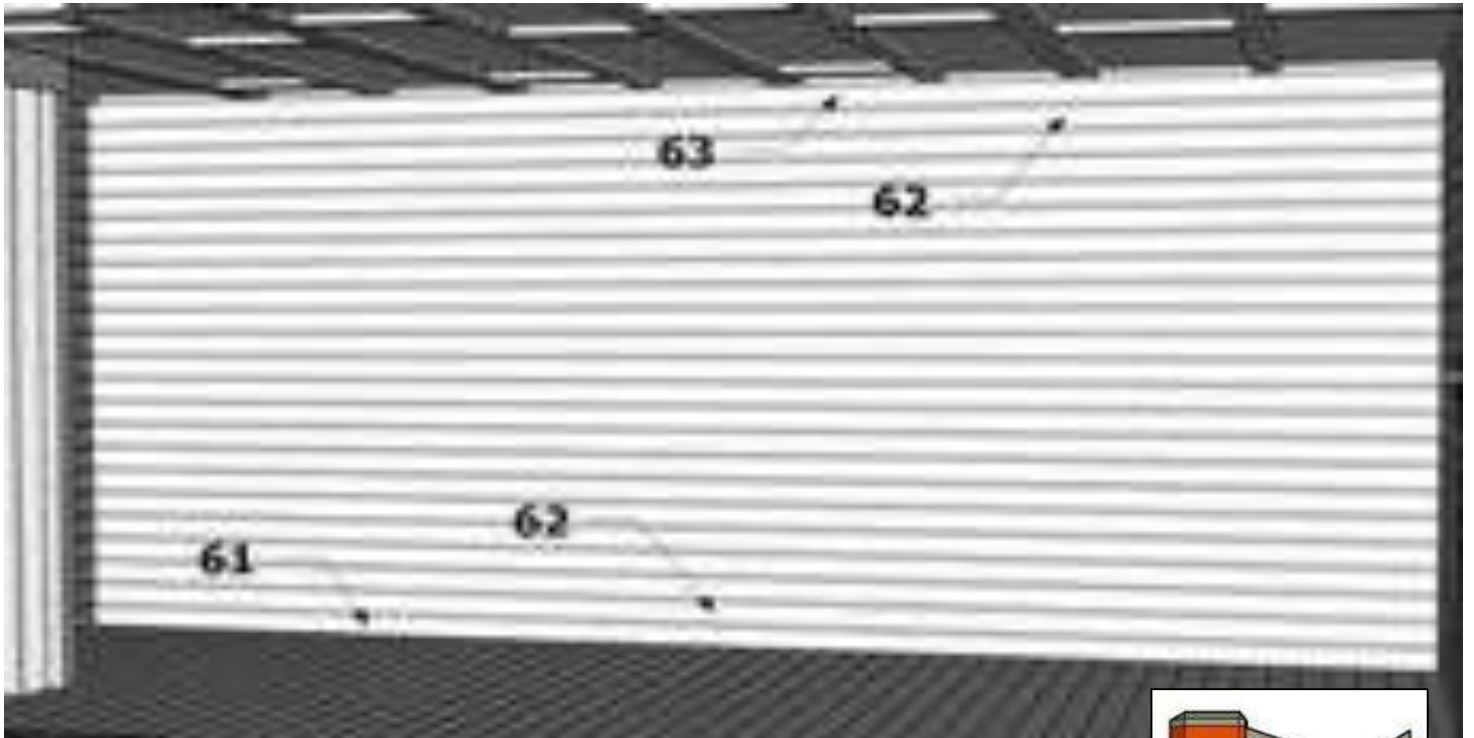
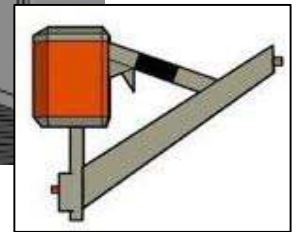

+ **61** + **62** + **63**

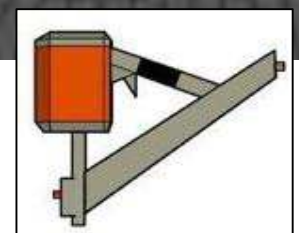

OFFICE 21 insulated Assembly instruction

19/28

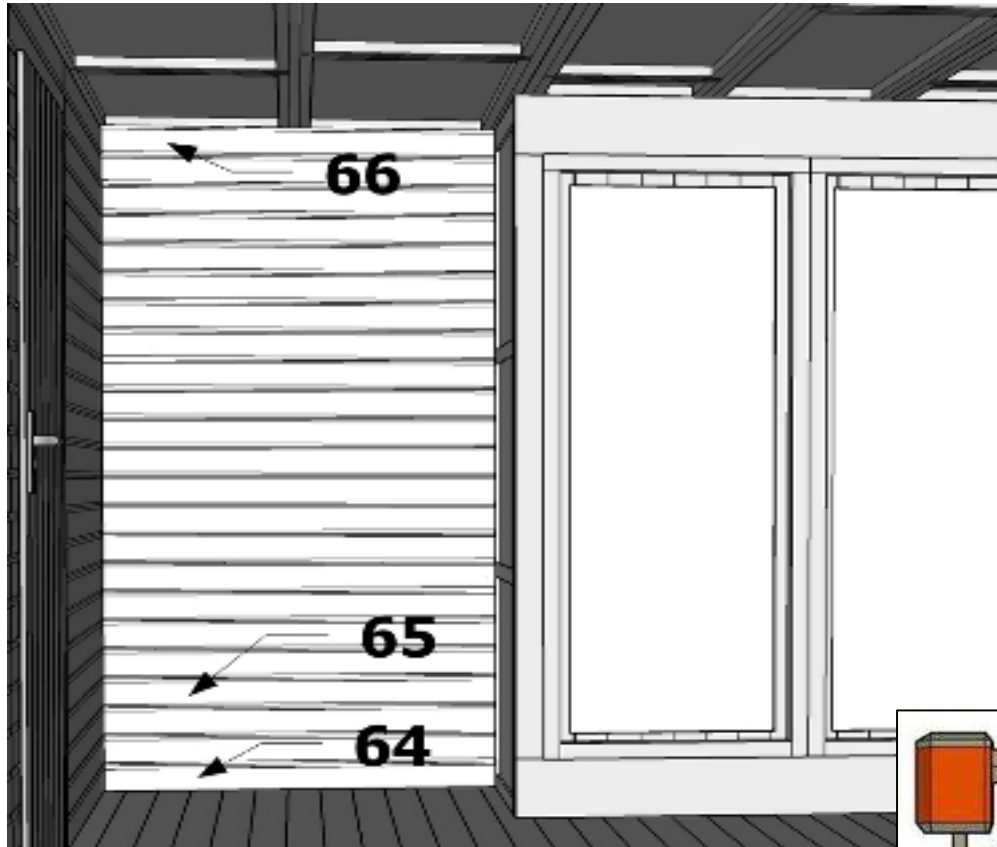

+ **64** + **65** + **66**

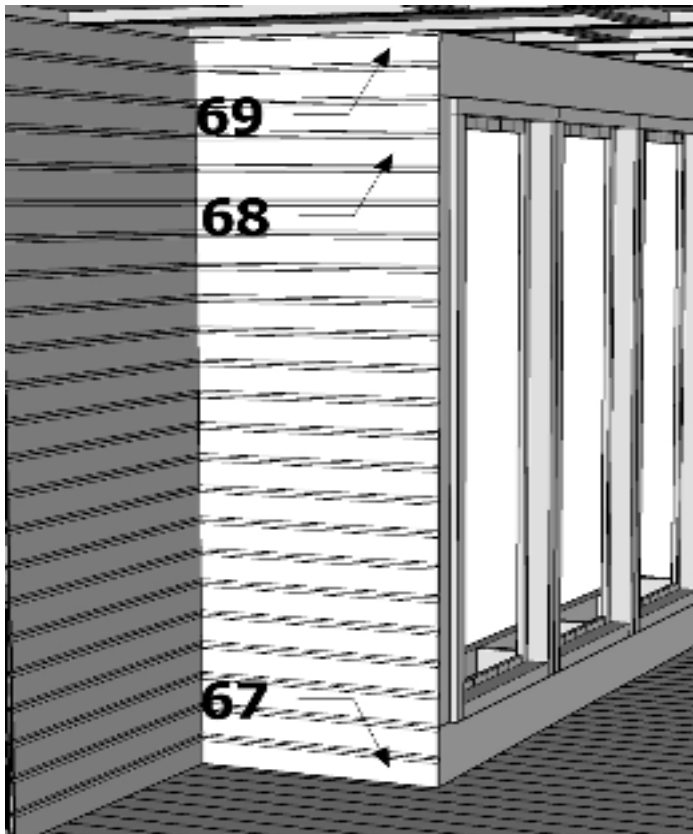

+ **67** + **68** + **69**

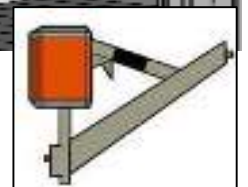

OFFICE 21 insulated Assembly instruction

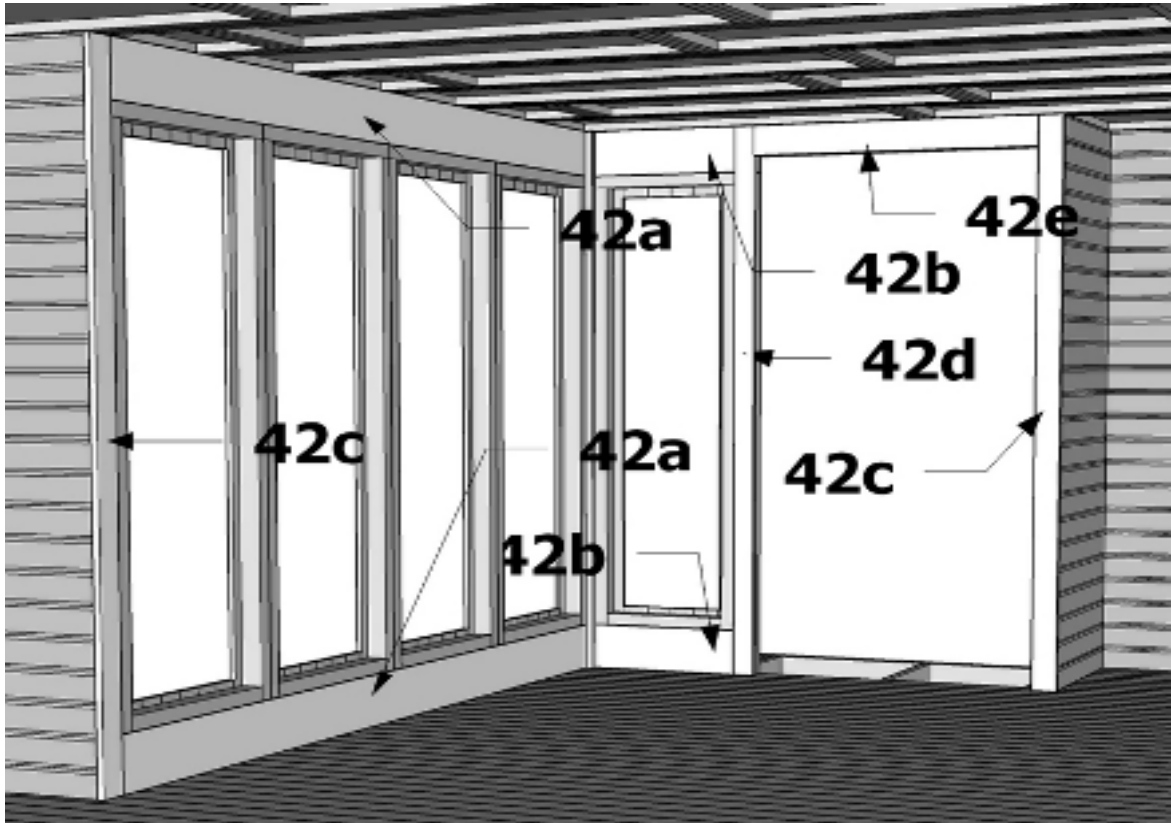

- | | | | | | | | |
|---|------------|---|------------|---|------------|--|--|
| + | 42a | + | 42c | + | 42b | | |
| + | 42d | + | 42e | + | 42c | | |
- | | |
|----|----------|
| 66 | 3,5 x 40 |
|----|----------|

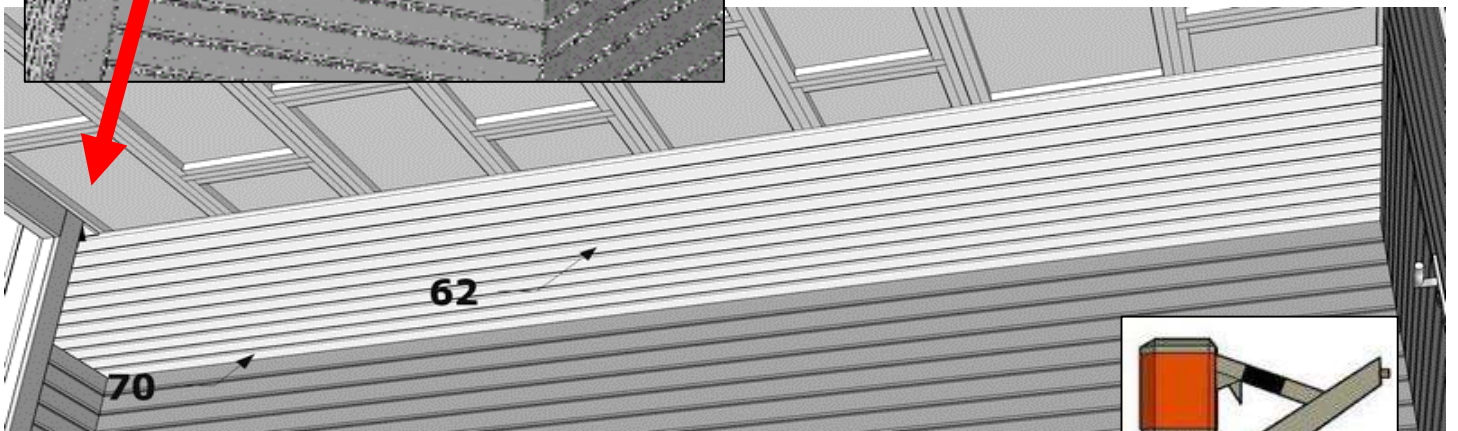
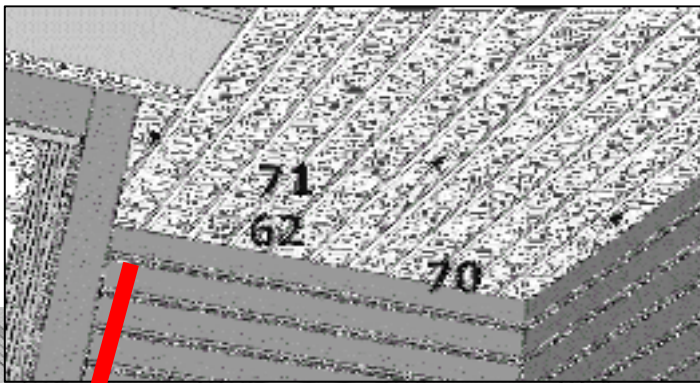

- | | | | | | |
|---|-----------|---|-----------|---|-----------|
| + | 70 | + | 62 | + | 71 |
|---|-----------|---|-----------|---|-----------|

OFFICE 21 insulated Assembly instruction

21/28

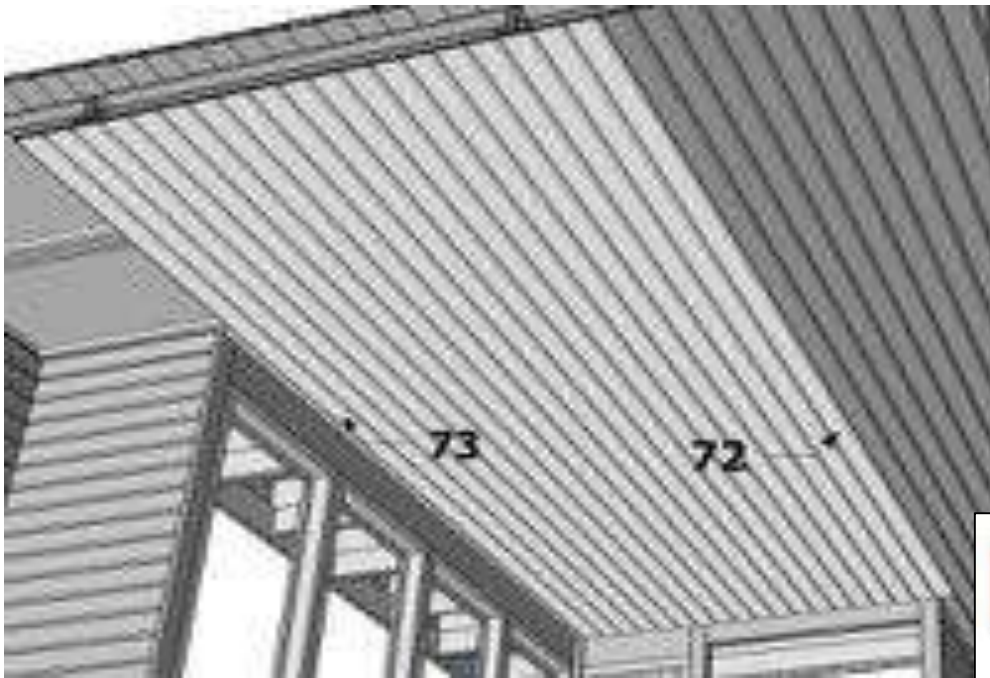

+ **72** + **73**

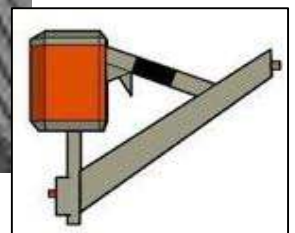

+ **74** + **75**

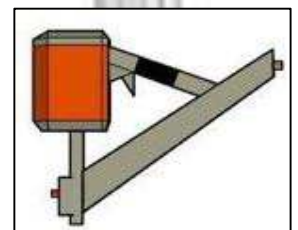

OFFICE 21 insulated Assembly instruction

22/28

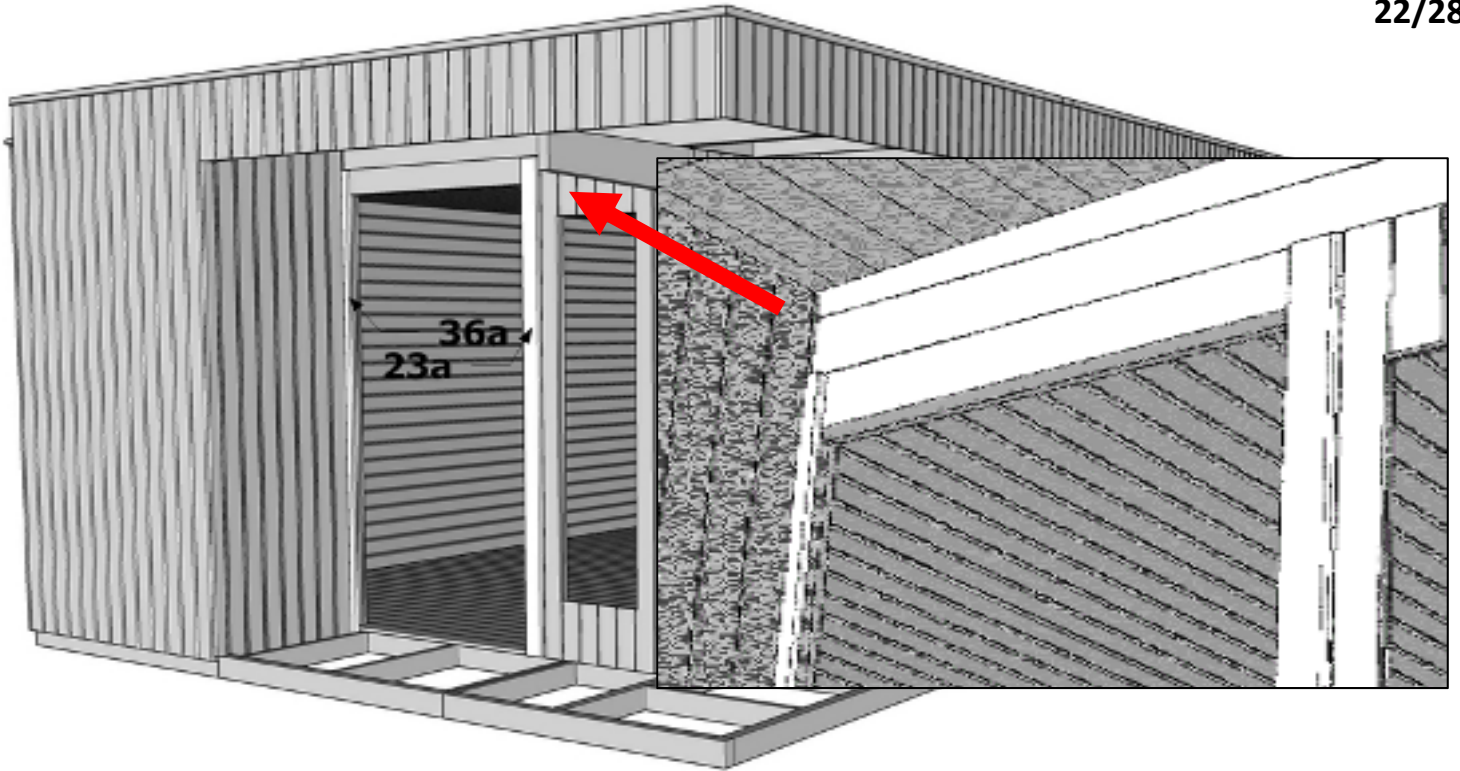

+ **23a** + **36a**

16	3,5 x 40
-----------	----------



+ **36b** + **36c**

8	3,5 x 40
----------	----------

OFFICE 21 insulated Assembly instruction

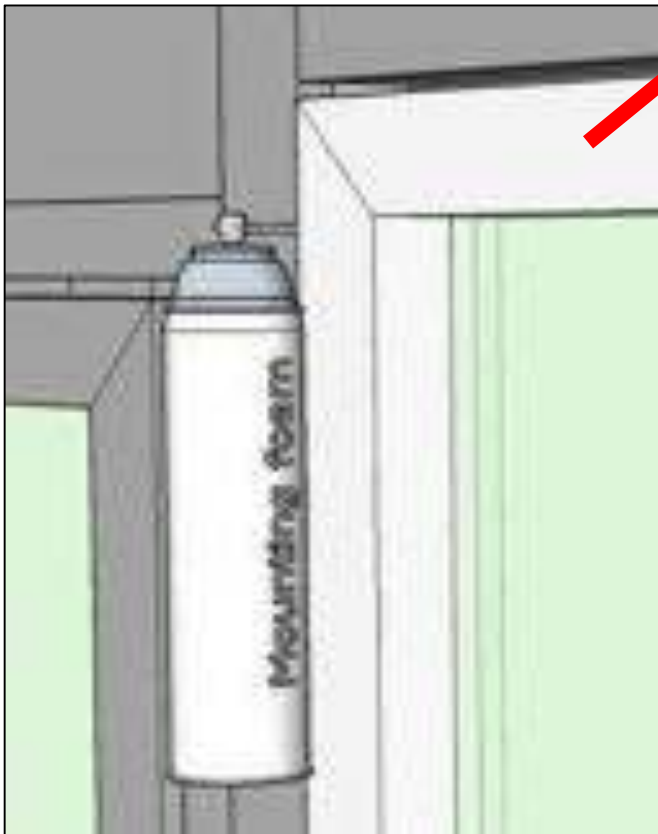
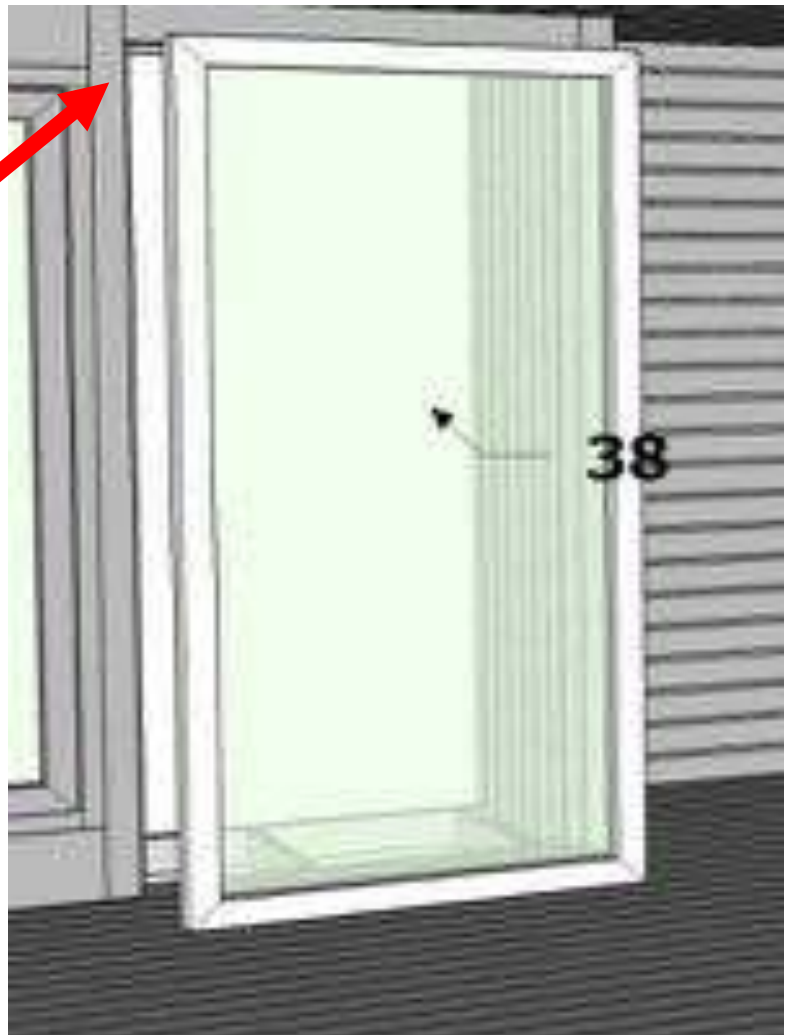

OFFICE 21 insulated Assembly instruction

24/28

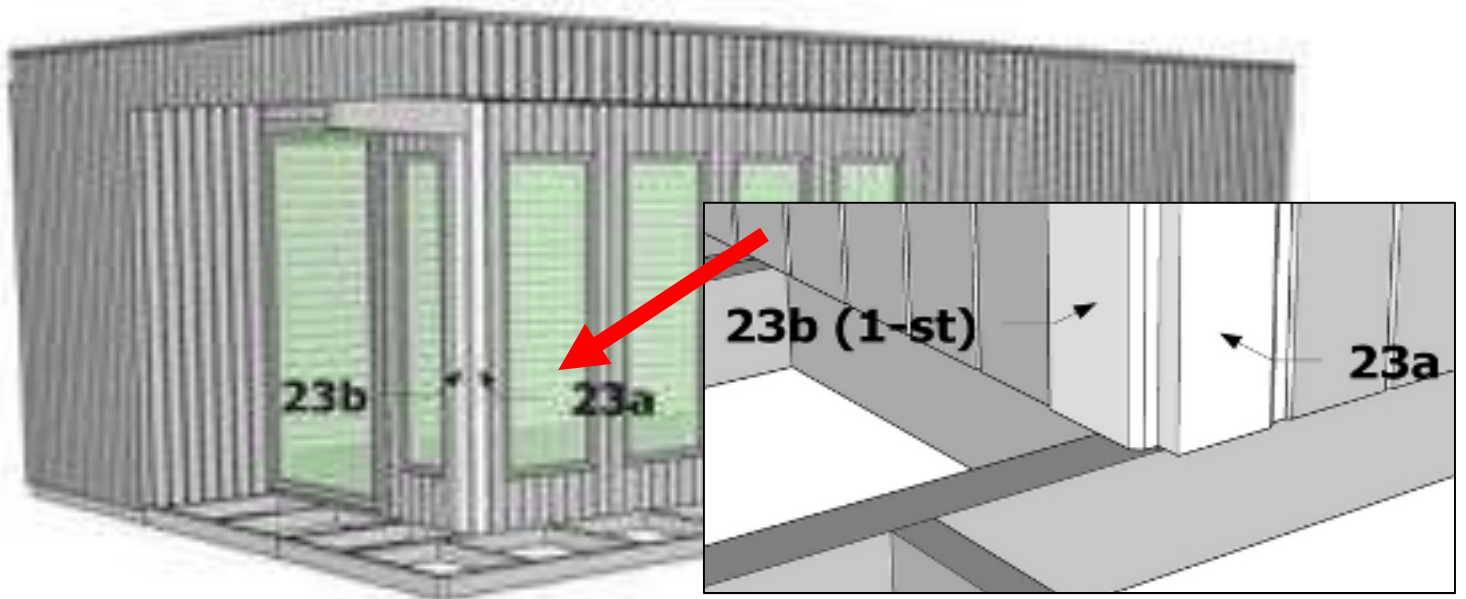

+ **23a** + **23b**

16	3,5 x 40
----	----------

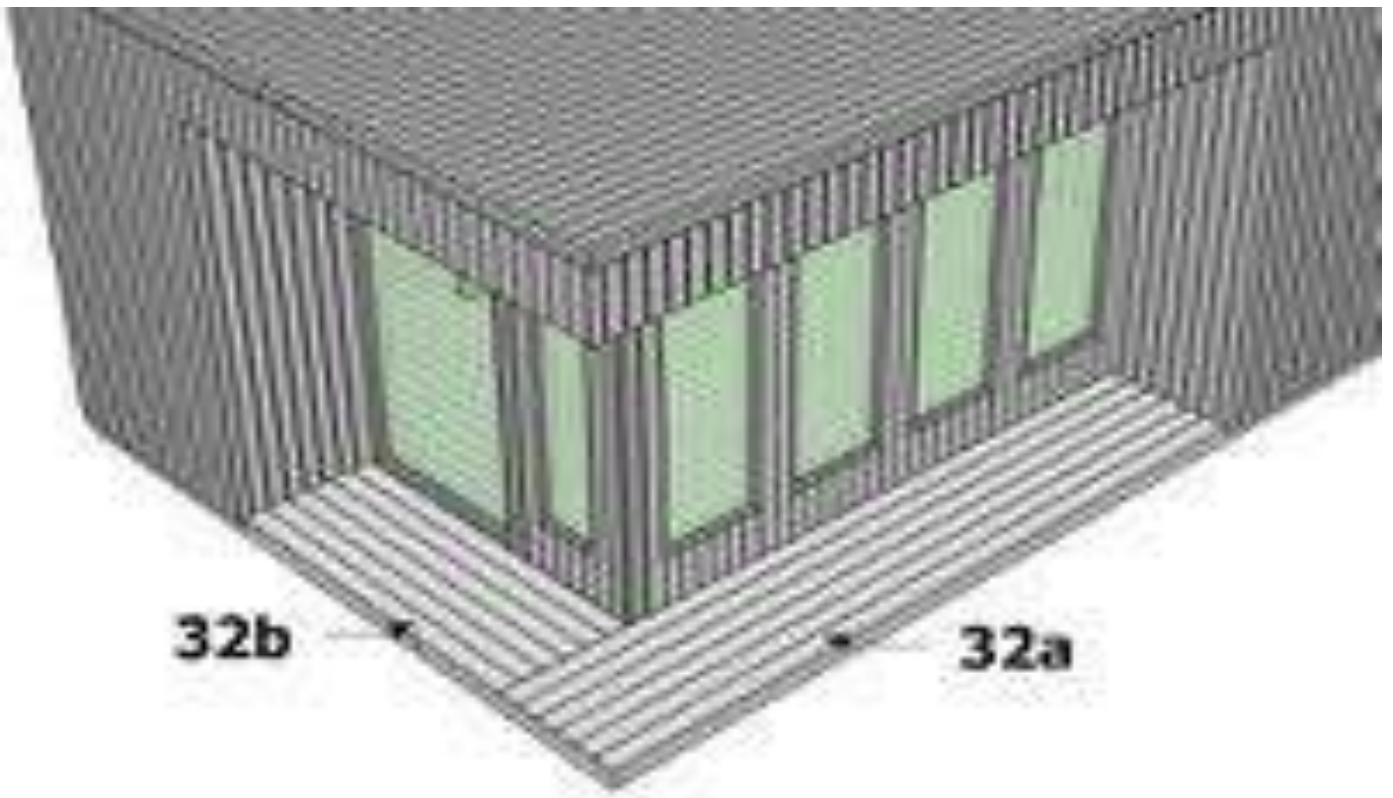

+ **32a** + **32b**

132	3,5 x 40
-----	----------

OFFICE 21 insulated Assembly instruction

25/28

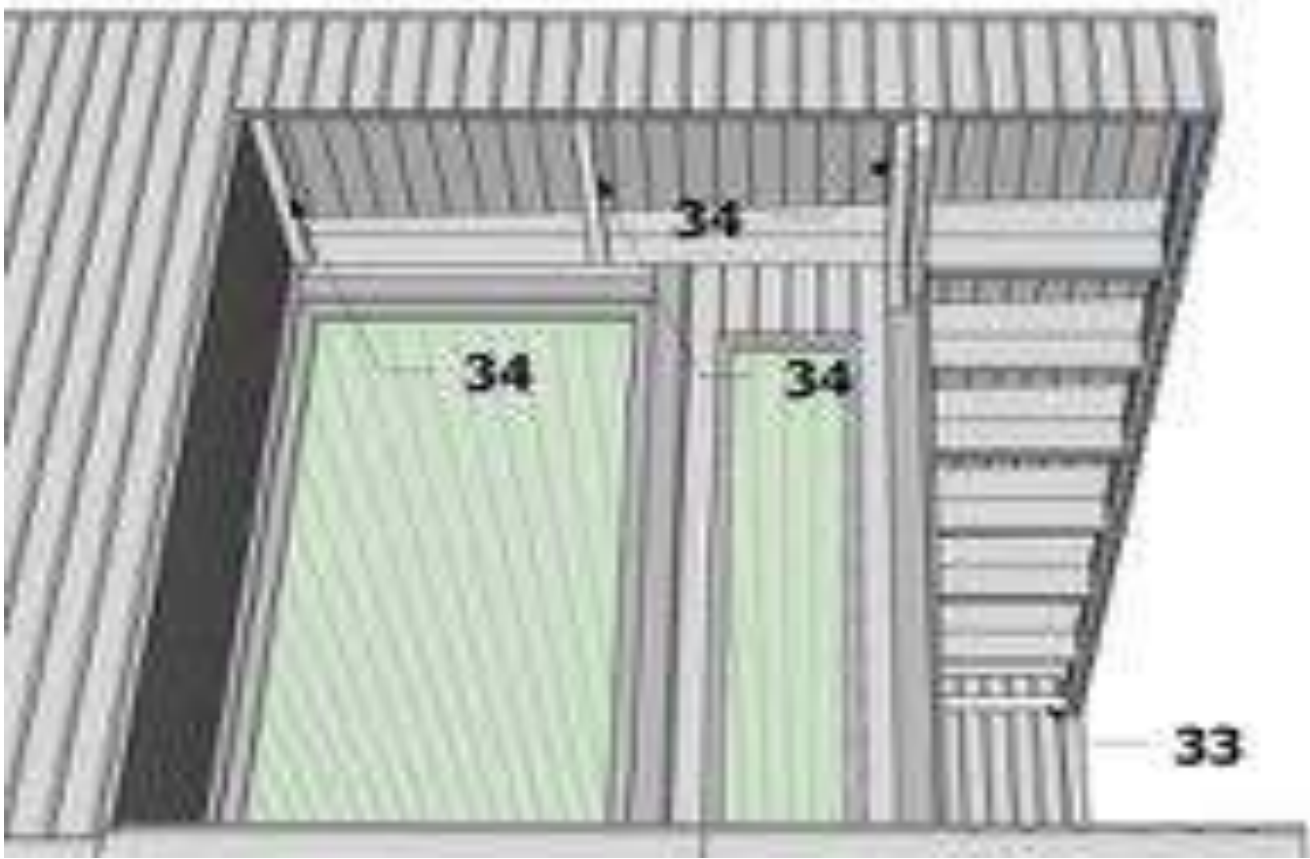

+ **33** + **34**

8	4,5 x 80
---	----------



+ **35a** + **35b**

132	3,5 x 40
-----	----------

OFFICE 21 insulated Assembly instruction



+ **76** + **77** + **78**

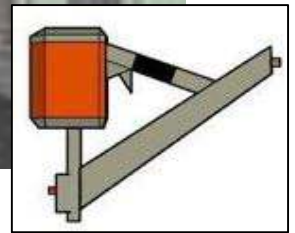

+ **81** + **78** + **82** + **81**
+ **79** + **79** + **80**

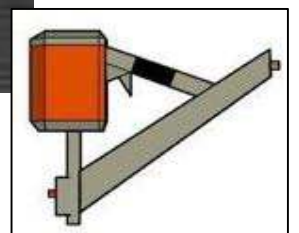

OFFICE 21 insulated Assembly instruction

27/28

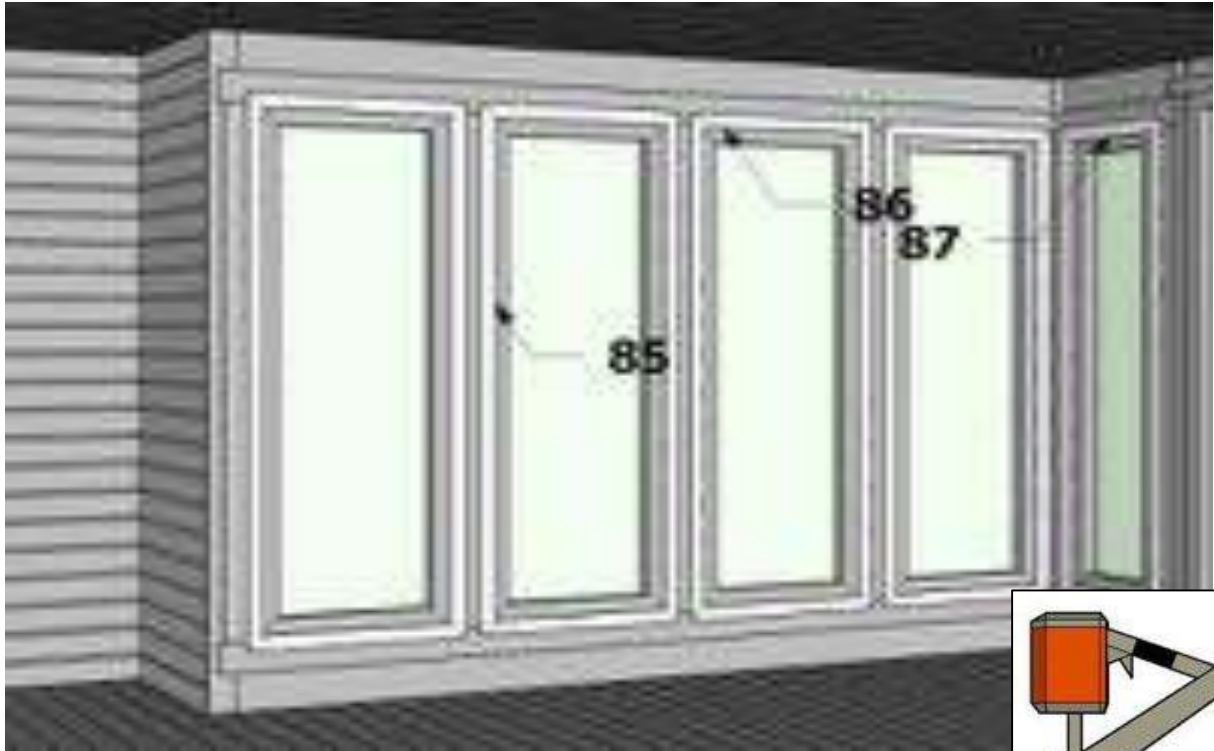

+ **85** + **86** + **87**

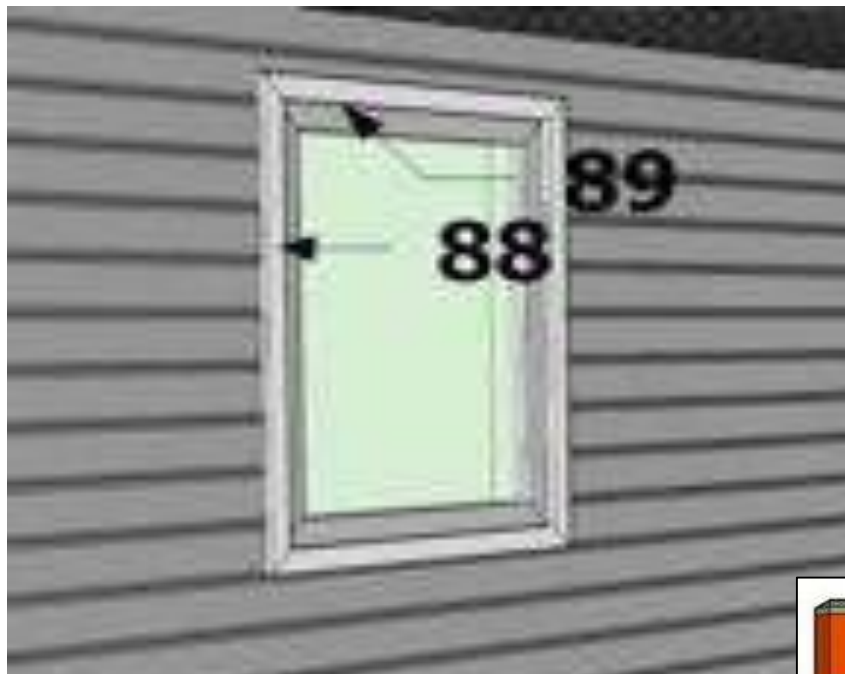
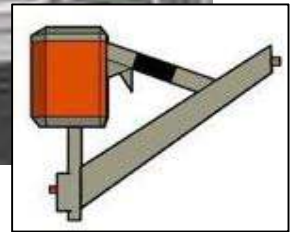

+ **86** + **87**

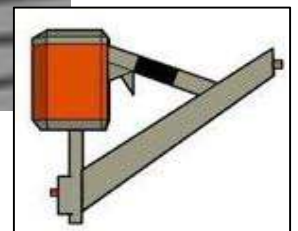

OFFICE 21 insulated Assembly instruction

28/28

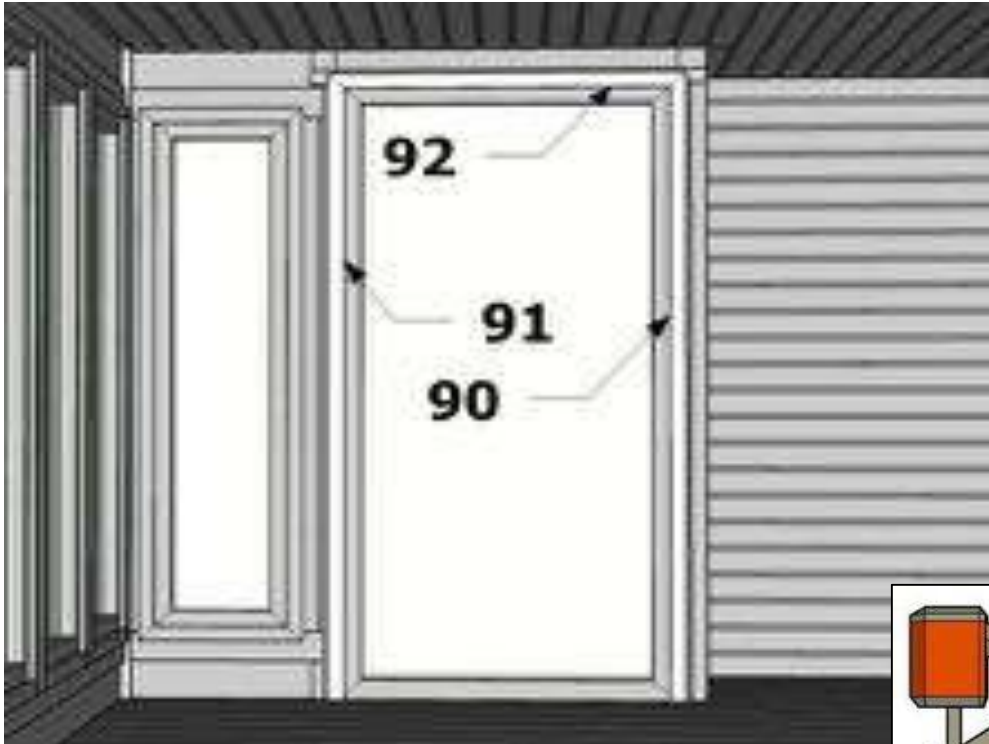

+ **90** + **91** + **92**

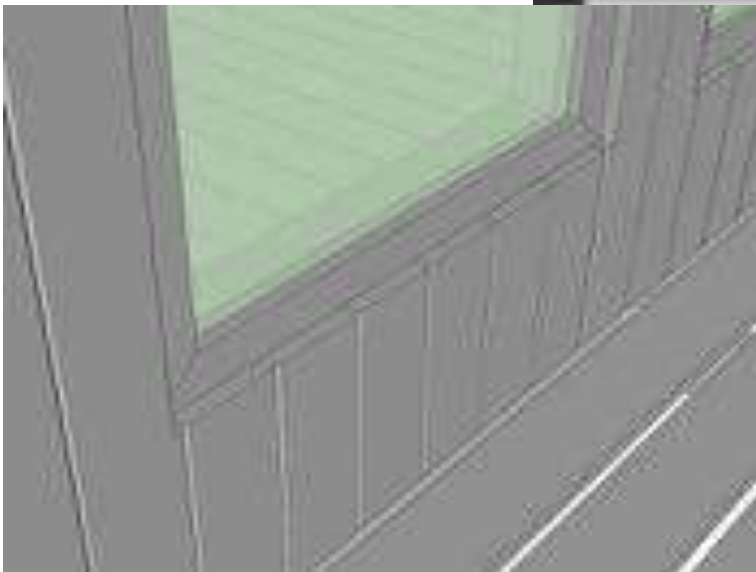
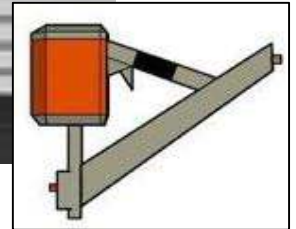

Use moldings pos. 83 and 84 there,
where You think need to be

+ **83** + **84**

