

Date rev. Description

House	P584.3-90 Anna	Sheet	1
-------	----------------	-------	---

Drawing	3D	Scale	
---------	----	-------	--

Material	90x160	Date	13.02.2017
----------	--------	------	------------

Drawer	RP	File	P584.3-90 Anna 3D.dwg
--------	----	------	-----------------------

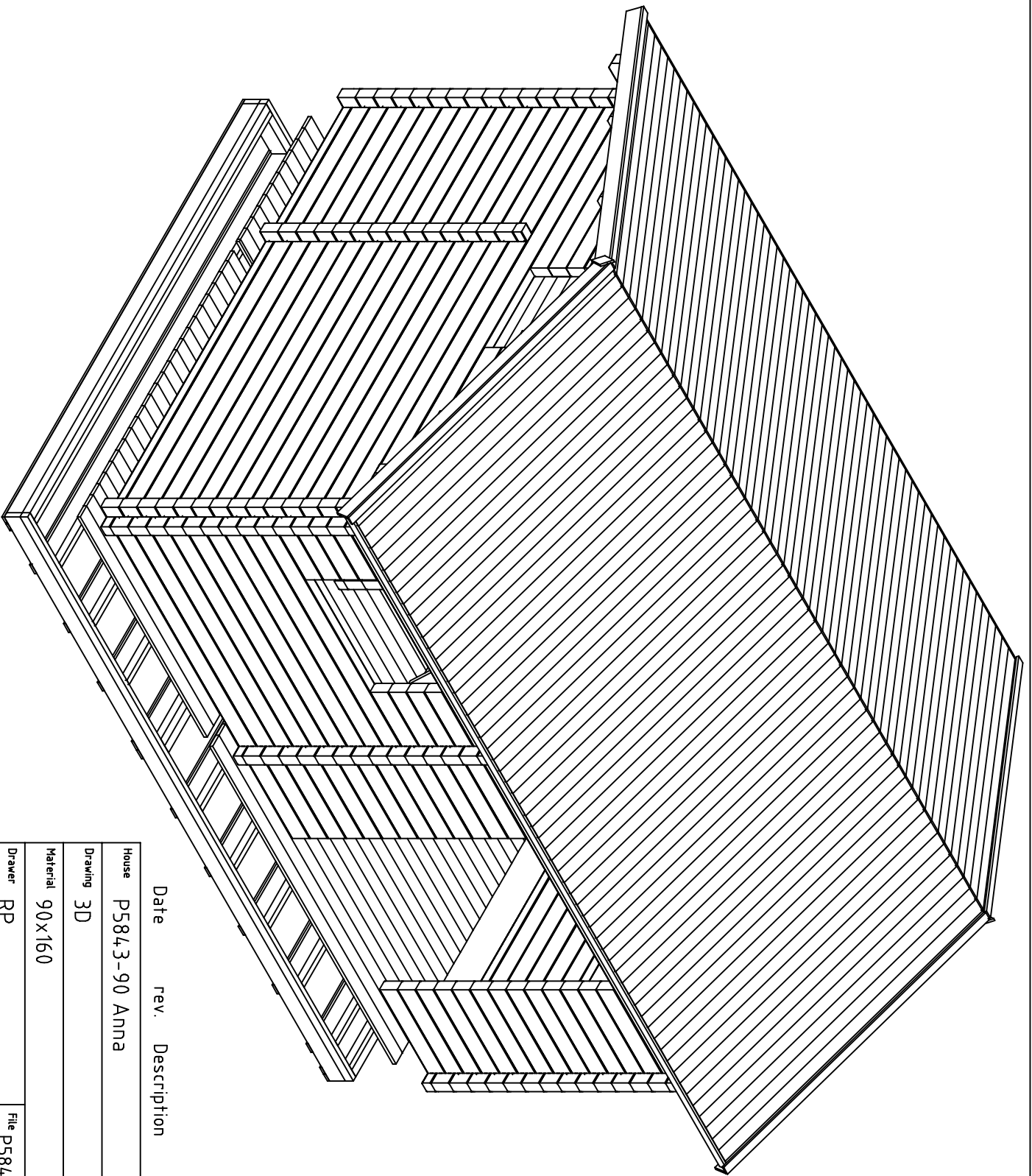

Date rev. Description

House	P5843-90 Anna	Sheet	2
-------	---------------	-------	---

Drawing	3D	Scale	
---------	----	-------	--

Material	90x160	Date	13.02.2017
----------	--------	------	------------

Drawer	RP	File	P5843-90 Anna 3D.dwg
--------	----	------	----------------------

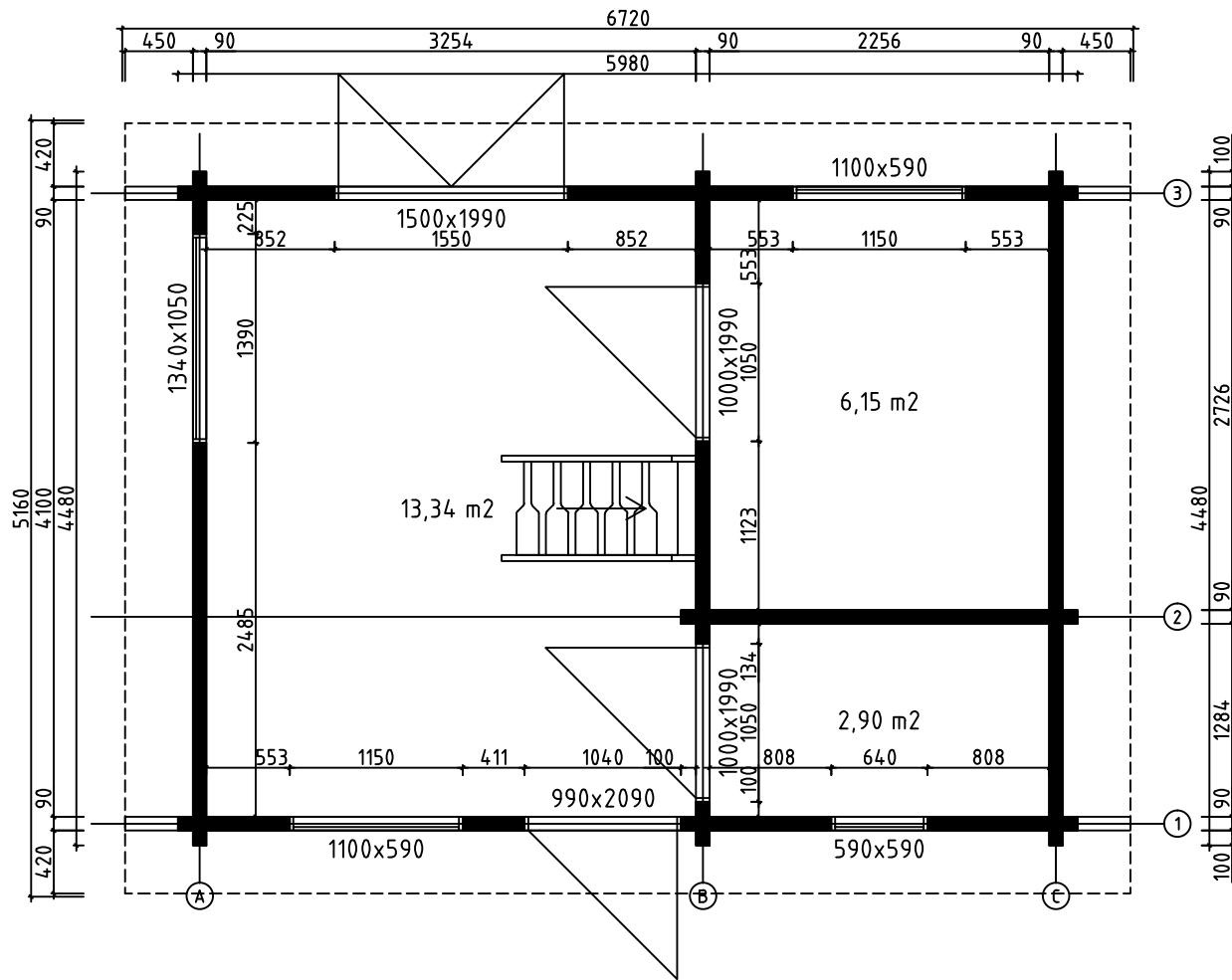

House	P5843-90 Anna	Sheet	3
Drawing	PLAN-SUUNNITELMA-PLANEN	Scale	1:50
Material	90x160	Date	13.02.2017
Drawer	RP	File	P5843-90 Anna.dwg

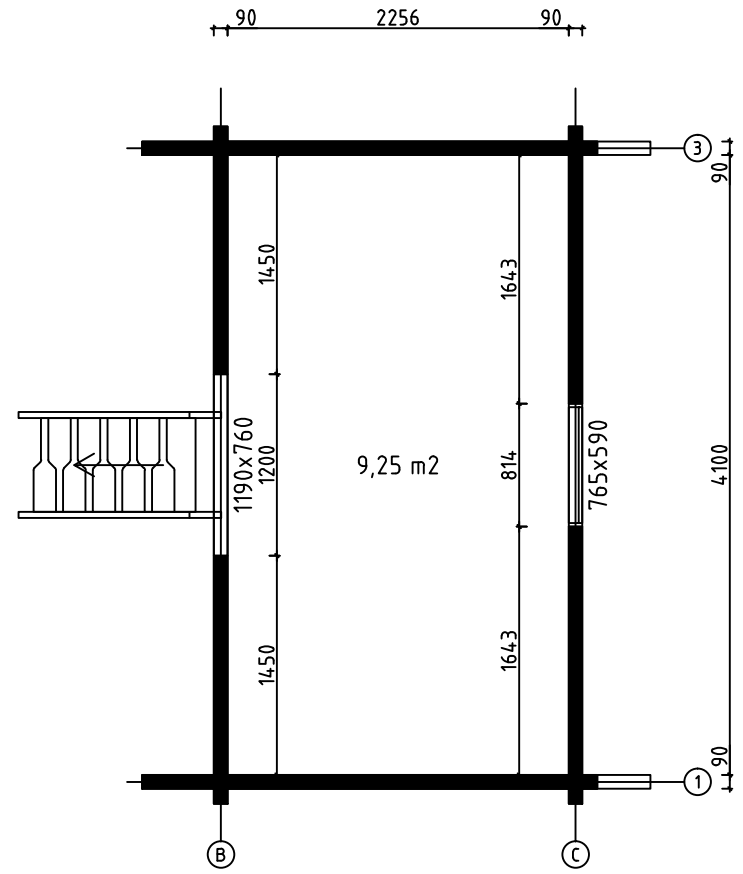
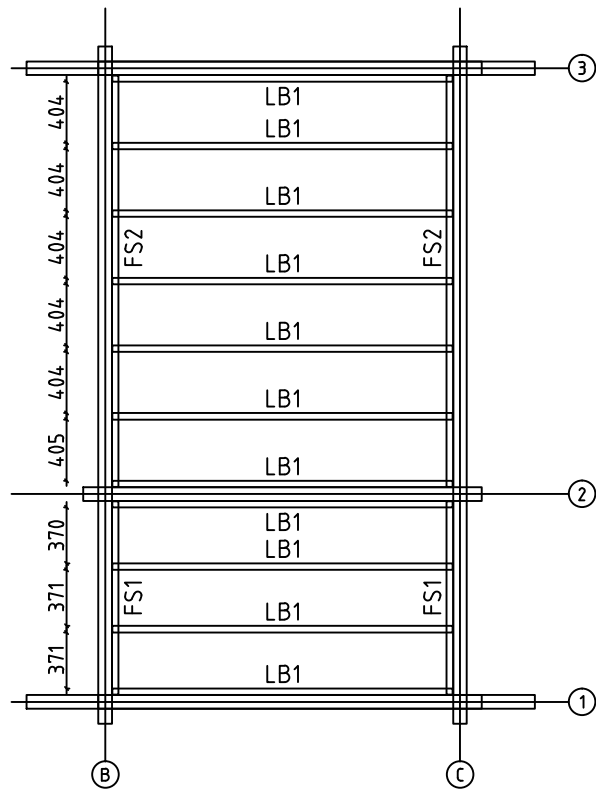

LOFT FLOOR BEAMS - PARVIA LATTIAPALKIT - LOFT GOLVBJÄLKAR

House	P5843-90 Anna	Sheet	4
Drawing	LOFT FLOOR - PARVIA LATTIA - LOFT GOLV	Scale	1:50
Material	43x43, 43x140 90x160	Date	13.02.2017
Drawer	RP	File	P5843-90 Anna.dwg

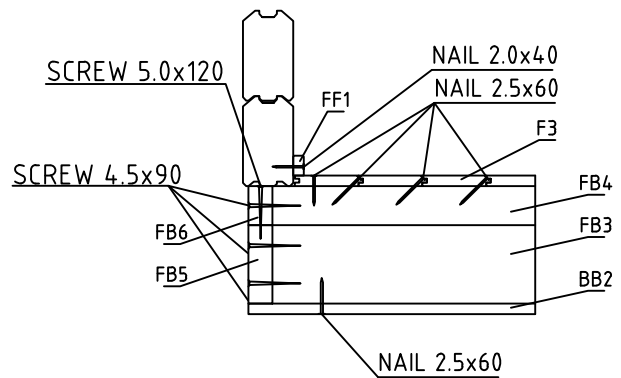
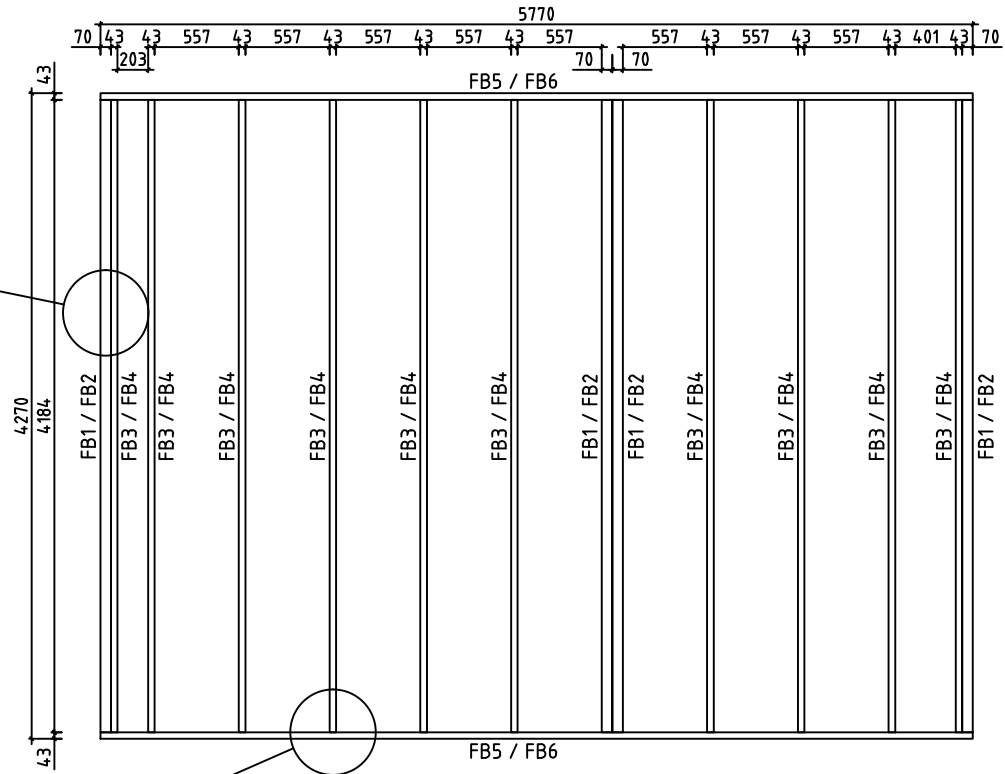
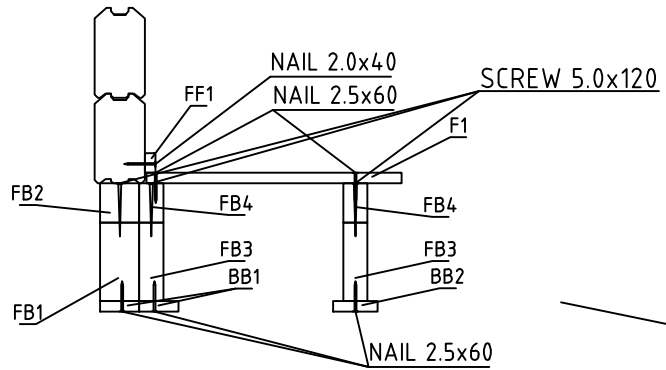

House	P5843-90 Anna	Sheet	5
Drawing	FLOORBEAMS-LATTIAPALKIT-GOLVBJÄLKAR	Scale	1:50
Material	70x140, 70x70, 43x140, 43x70	Date	13.02.2017
Drawer	RP	File	P5843-90 Anna.dwg

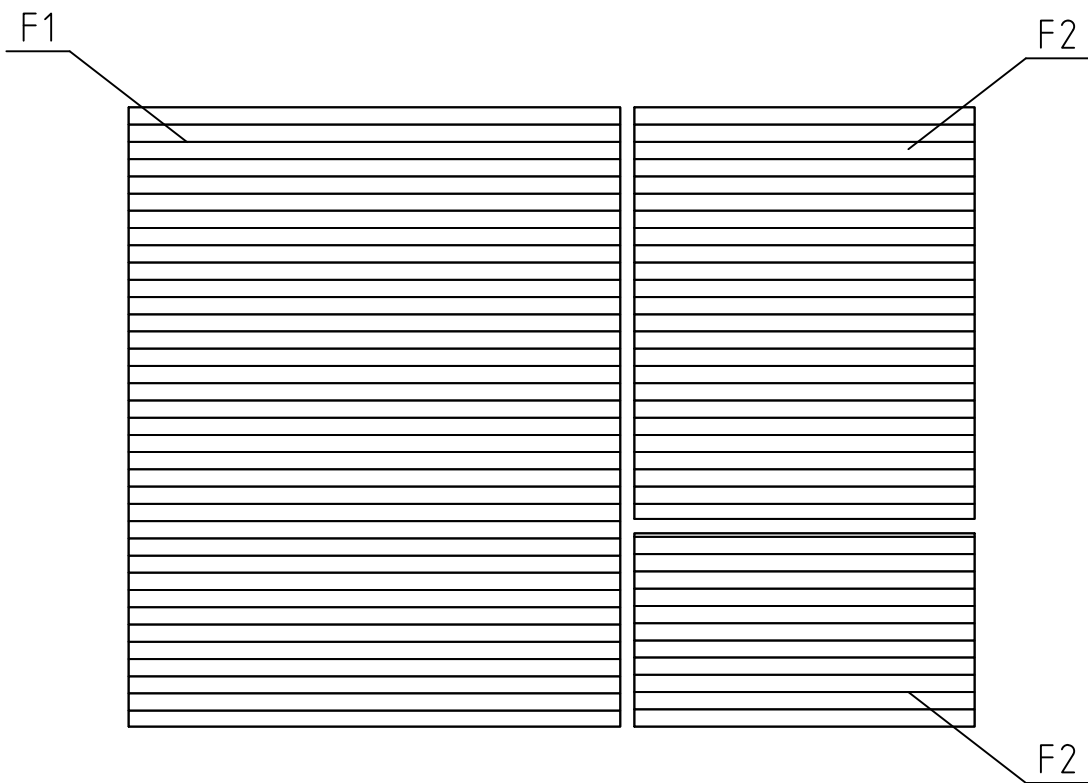

FLOORBOARD-LATTIALAUTA-GOLVBRÄDE

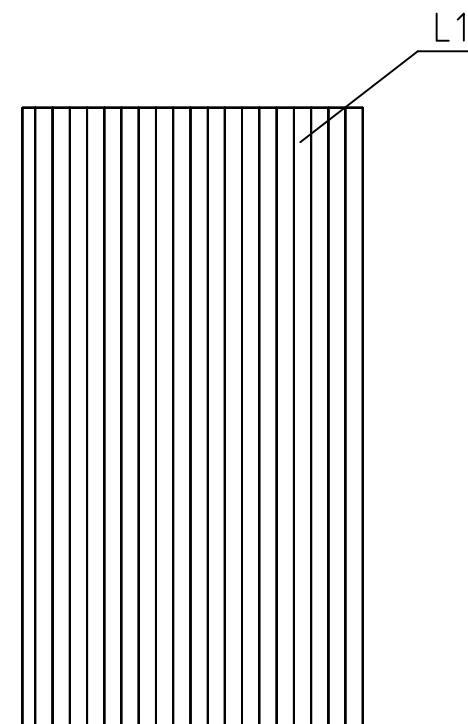

LOFT FLOORBOARD - PARVIA LATTIALATTIA - LOFT GOLVBRÄDE

House	P5843-90 Anna	Sheet	6
Drawing	FLOORBOARD-LATTIALAUTA-GOLVBRÄDE	Scale	1:50
Material	114x28, 114x19	Date	13.02.2017
Drawer	RP	File	P5843-90 Anna.dwg

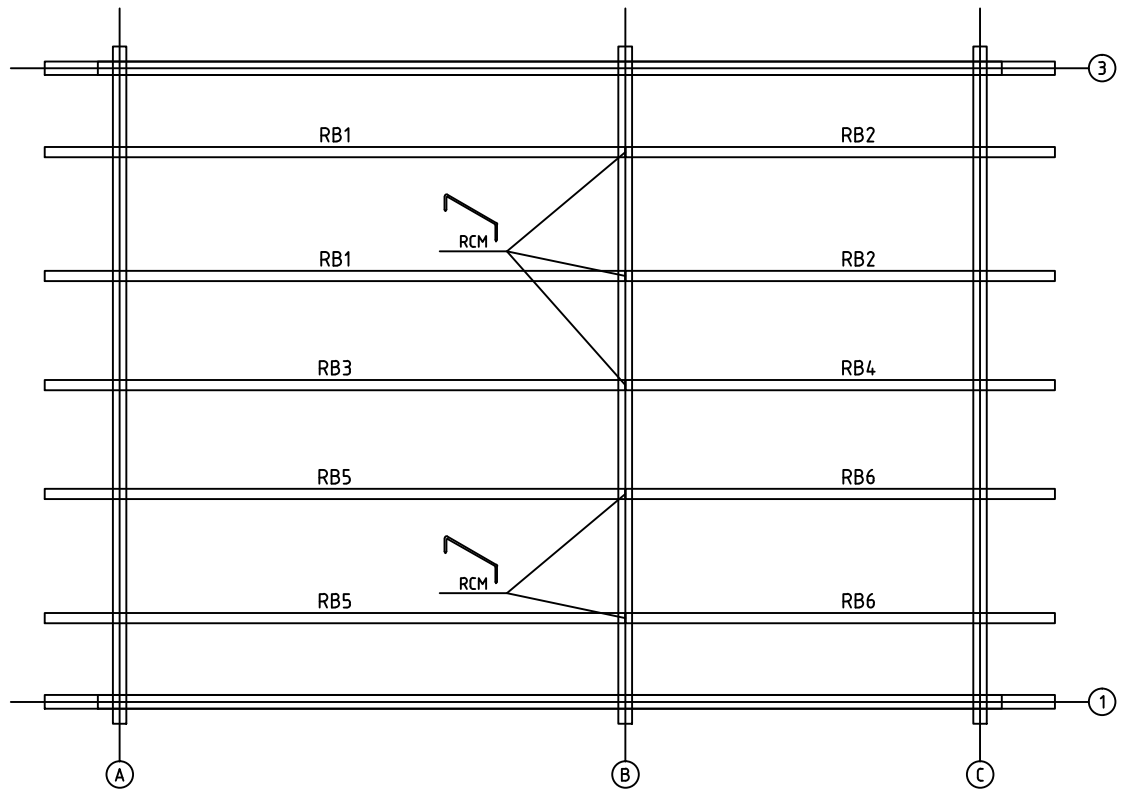

House	P5843-90 Anna	Sheet	7
Drawing	PURLINS-KATTO-ORRET-TAKÅSAR	Scale	1:50
Material	68x190	Date	13.02.2017
Drawer	RP	File	P5843-90 Anna.dwg

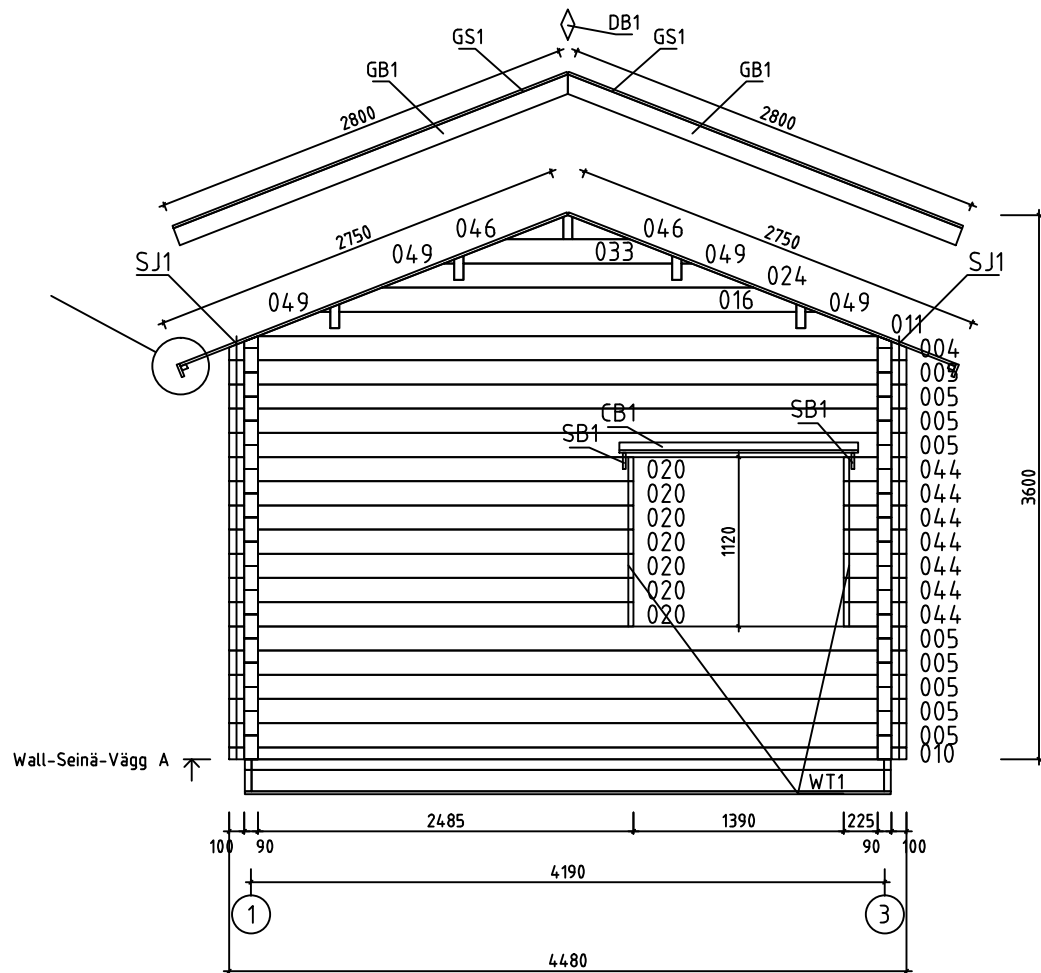
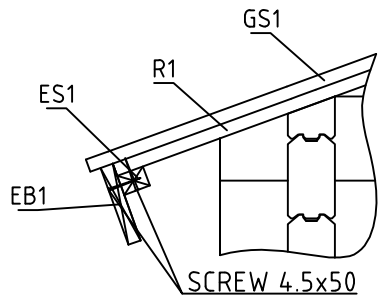

House	P5843-90 Anna	Sheet	8
Drawing	WALL-SEINÄ-VÄGG A	Scale	1:50
Material	90x160	Date	13.02.2017
Drawer	RP	File	P5843-90 Anna.dwg

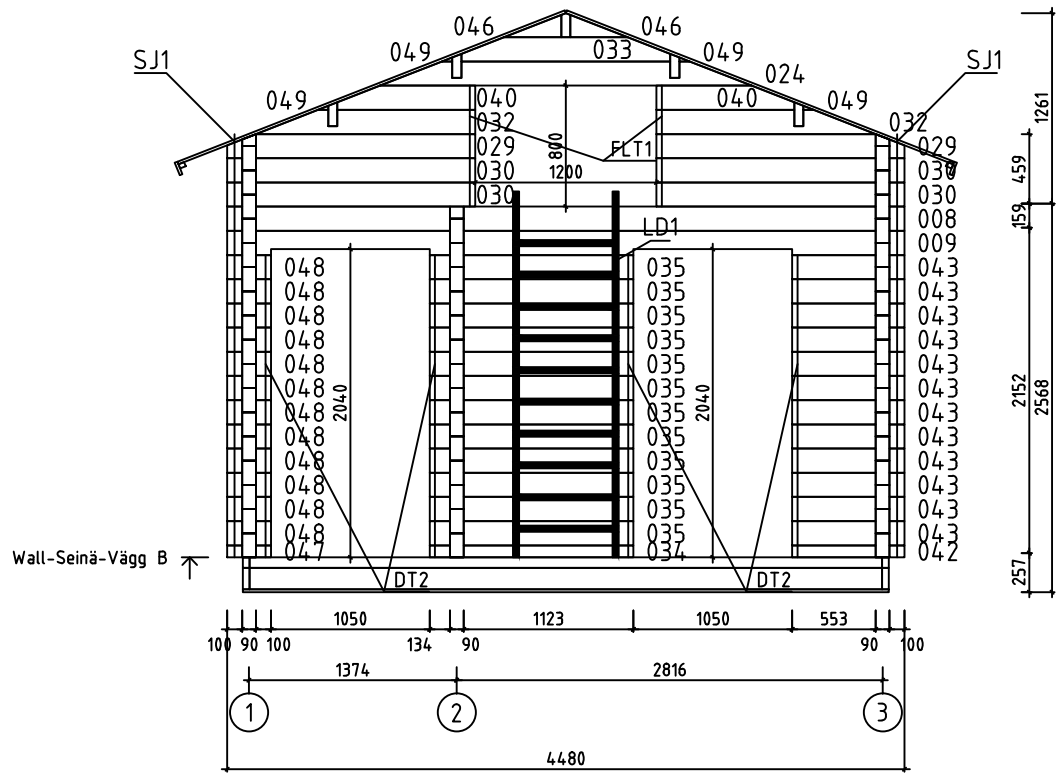

House	P5843-90 Anna	Sheet	9
Drawing	WALL-SEINÄ-VÄGG B	Scale	1:50
Material	90x160	Date	13.02.2017
Drawer	RP	File	P5843-90 Anna.dwg

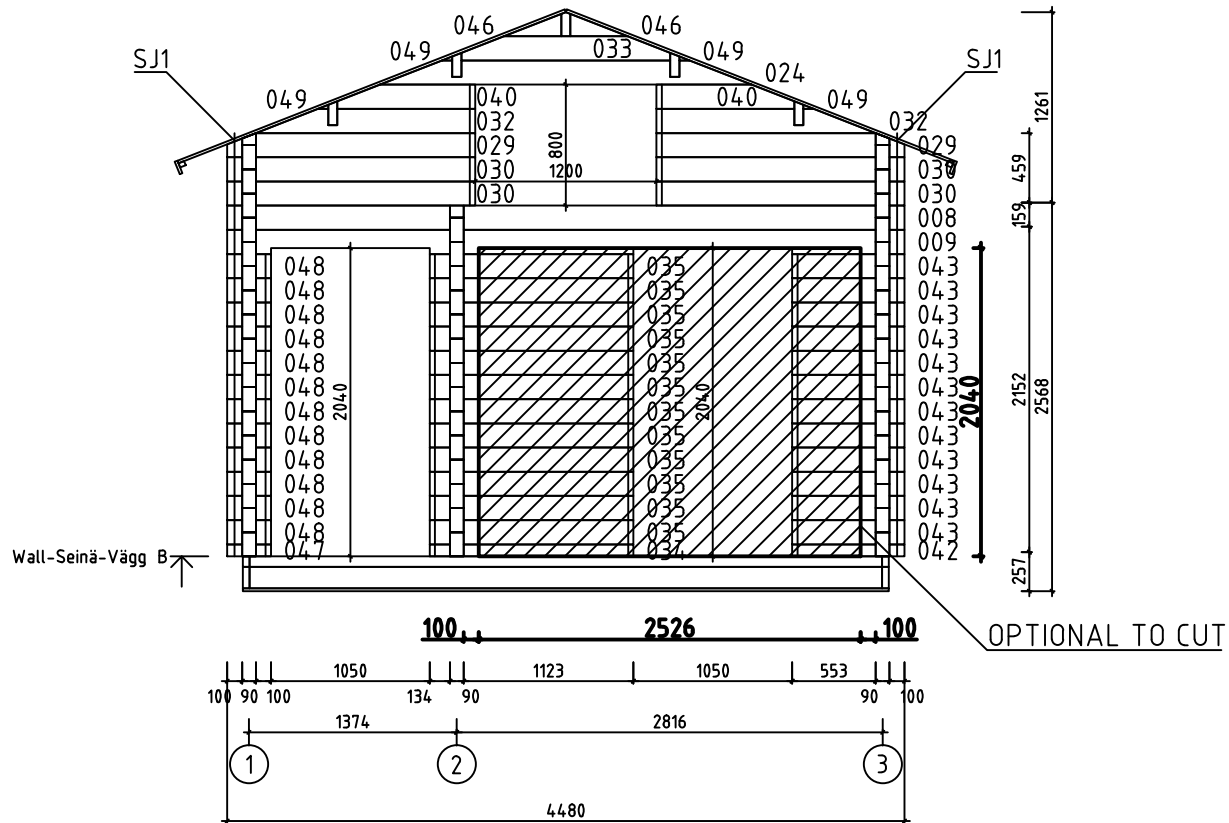

House	P5843-90 Anna	Sheet	9A
Drawing	WALL-SEINÄ-VÄGG B	Scale	1:50
Material	90x160	Date	13.02.2017
Drawer	RP	File	P5843-90 Anna Optional.dwg

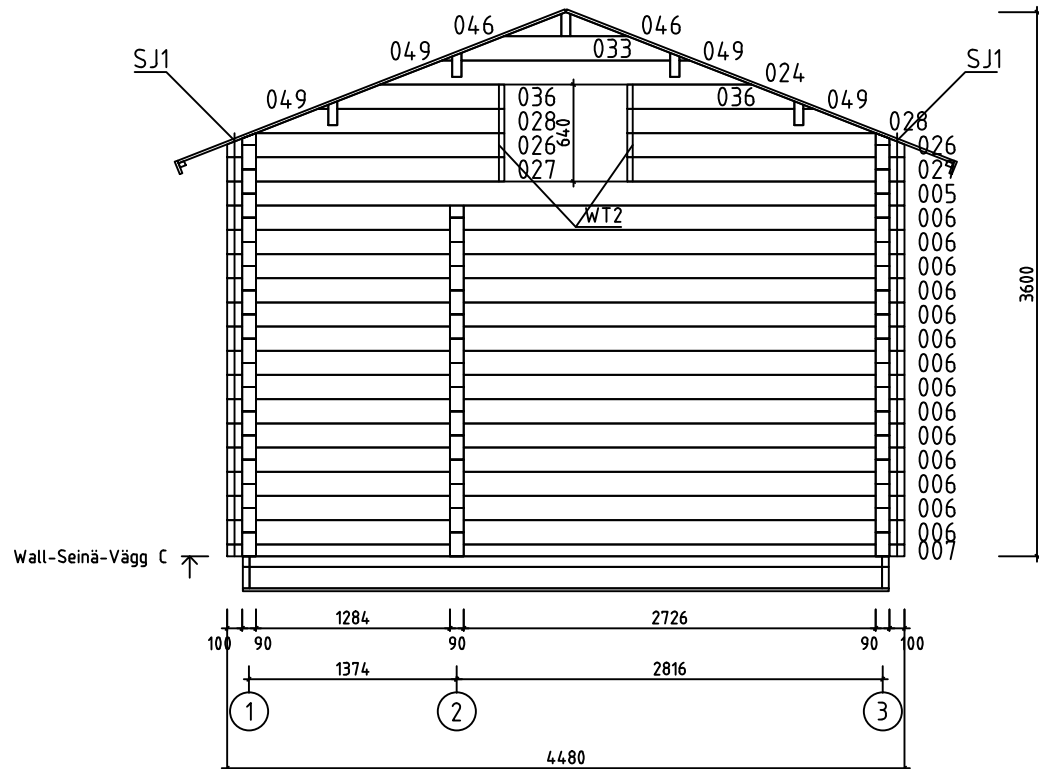

House	P5843-90 Anna	Sheet	10
Drawing	WALL-SEINÄ-VÄGG C	Scale	1:50
Material	90x160	Date	13.02.2017
Drawer	RP	File	P5843-90 Anna.dwg

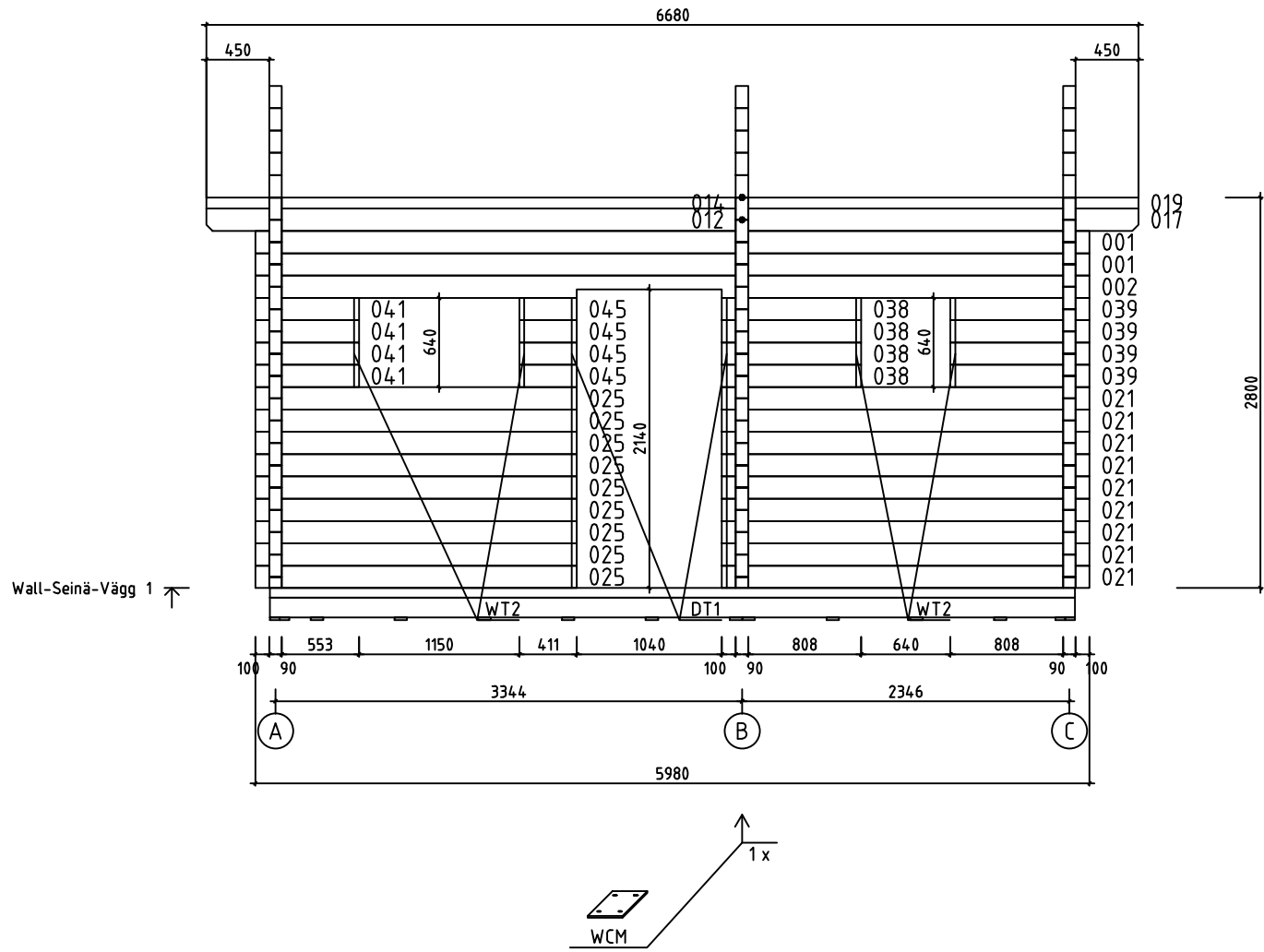

House	P5843-90 Anna	Sheet	11
Drawing	WALL-SEINÄ-VÄGG 1	Scale	1:50
Material	90x160	Date	13.02.2017
Drawer	RP	File	P5843-90 Anna.dwg

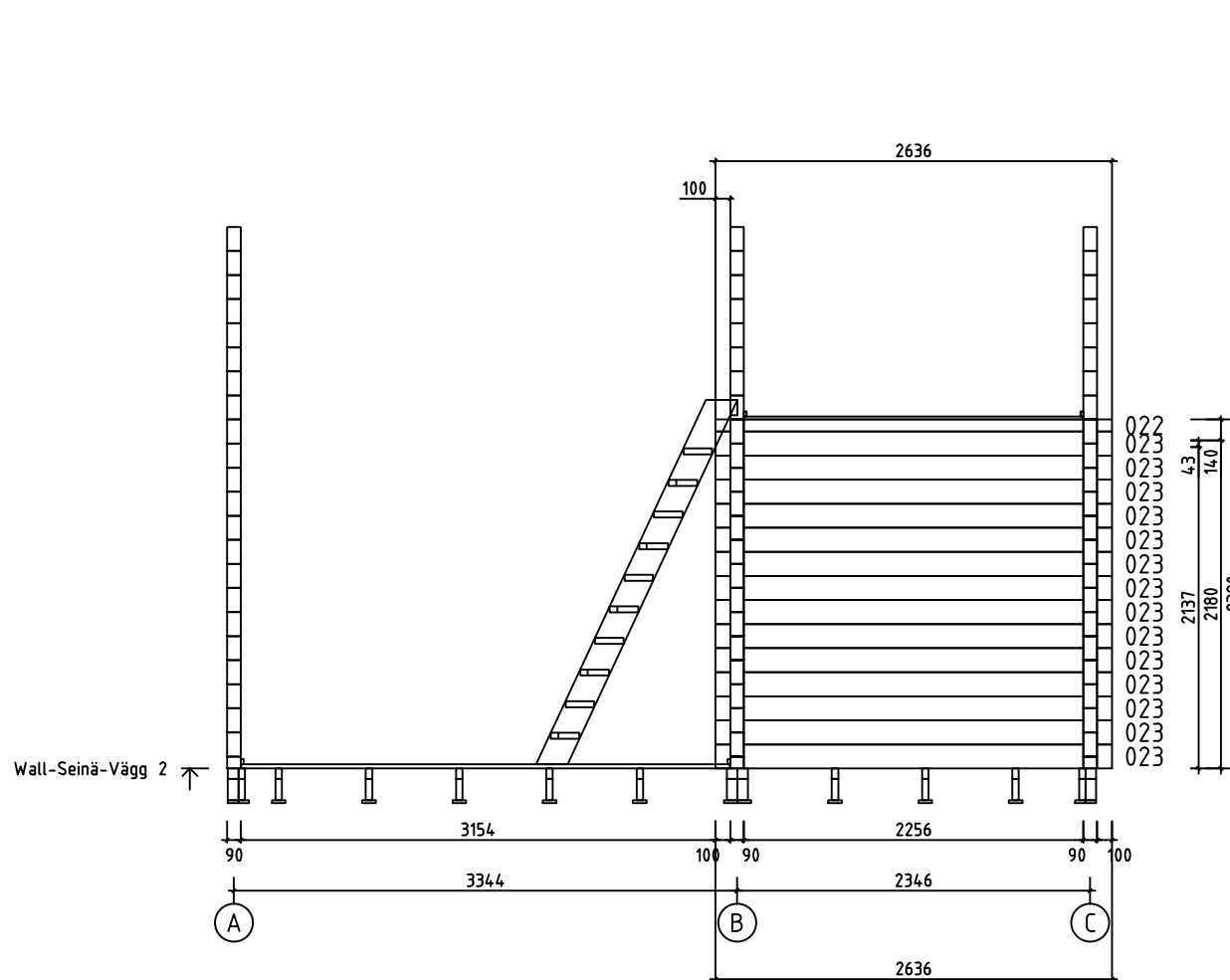



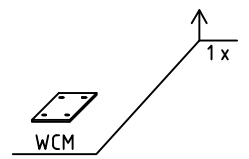
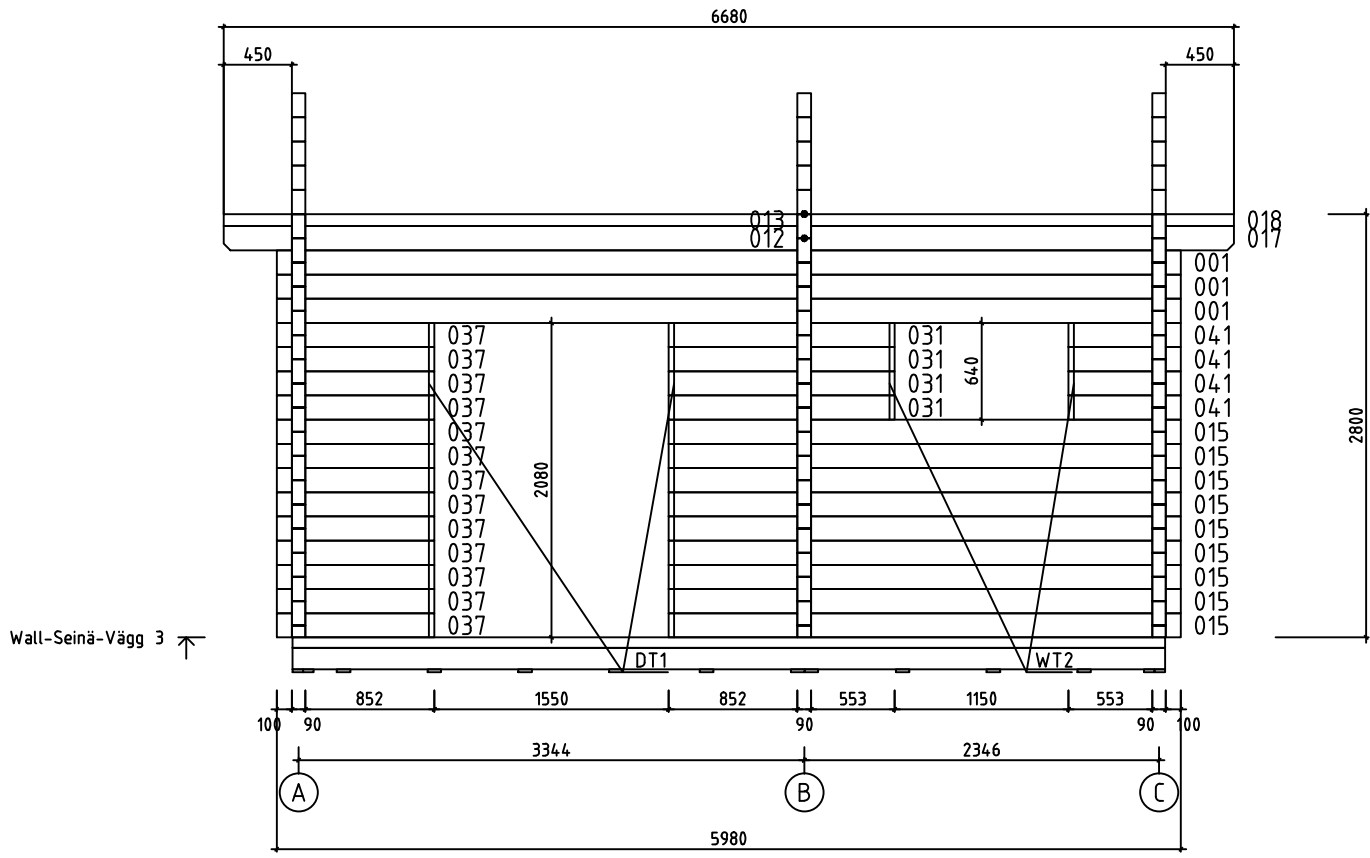



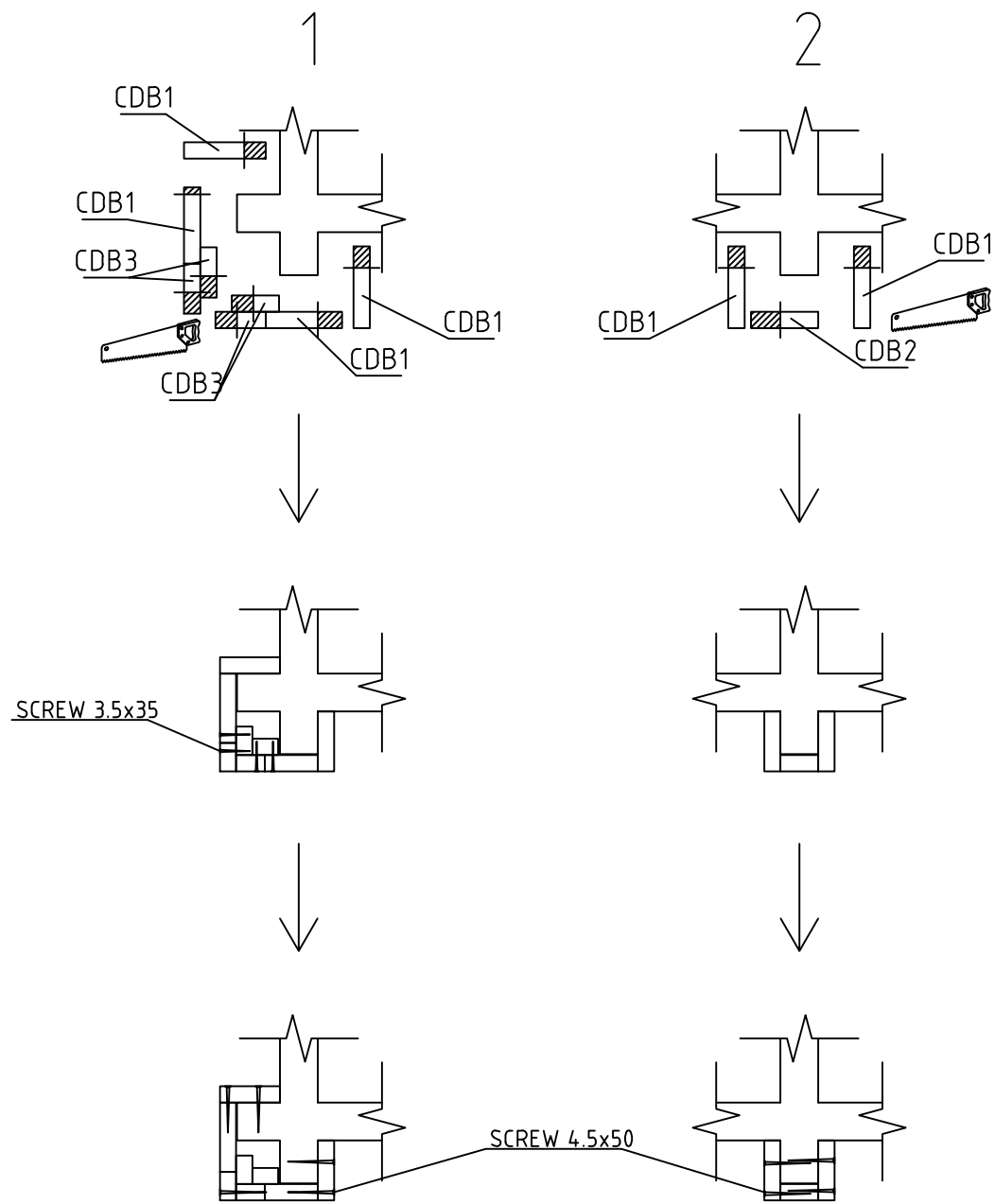
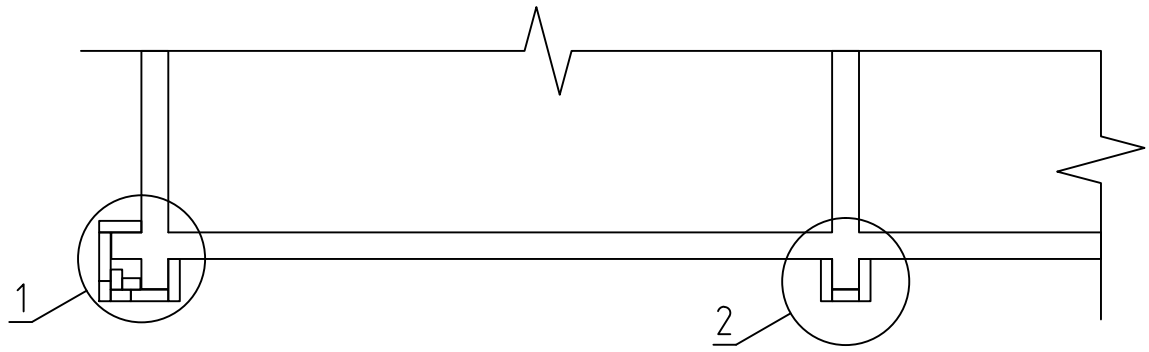



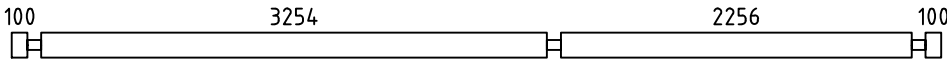
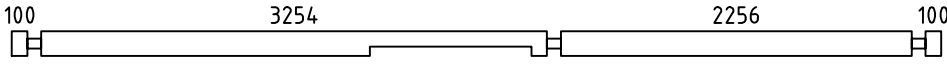
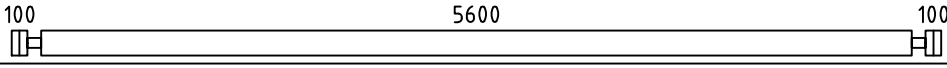
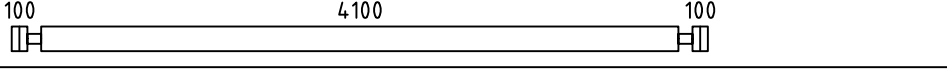
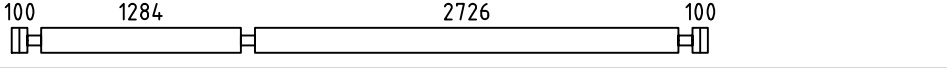
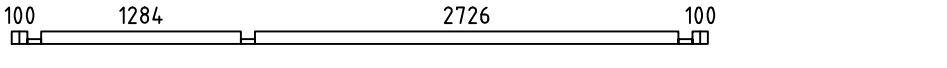
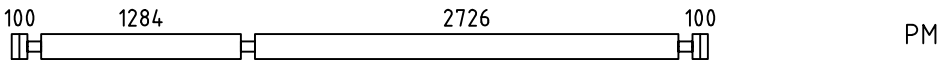
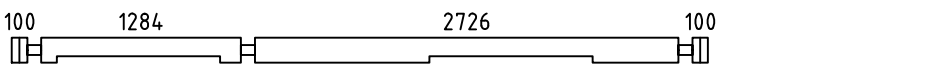
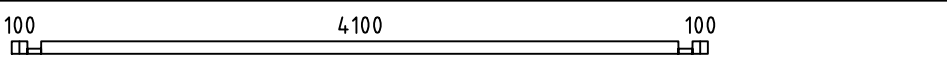
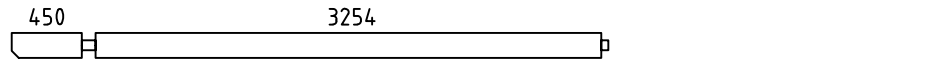
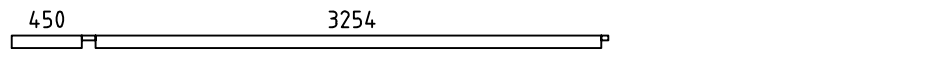
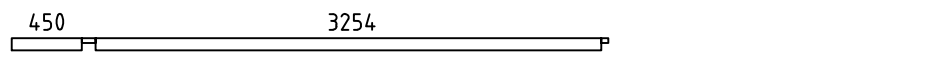
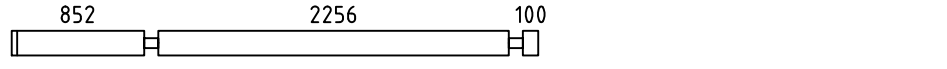

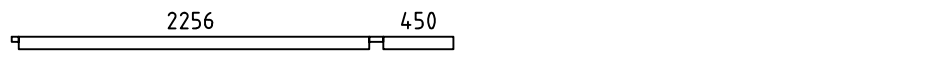
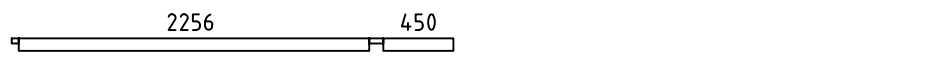
House	P5843-90 Anna	Sheet	12
Drawing	WALL-SEINÄ-VÄGG 2	Scale	1:50
Material	90x160	Date	13.02.2017
Drawer	RP	File	P5843-90 Anna.dwg











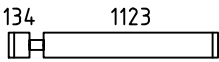
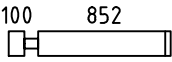
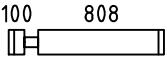
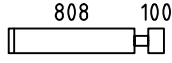
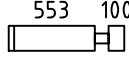
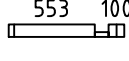
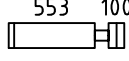



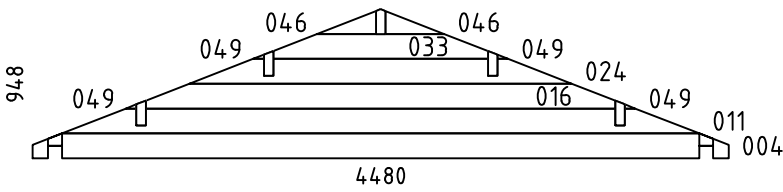
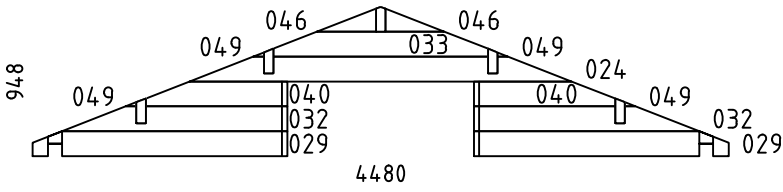
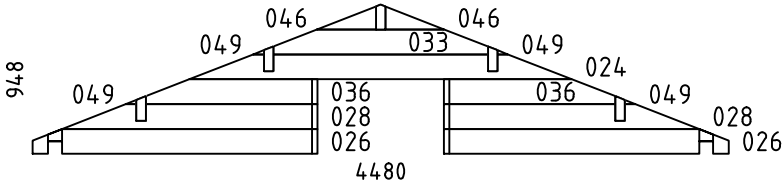

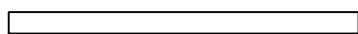
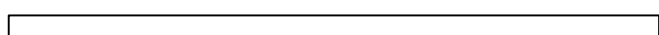
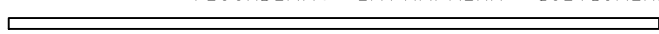
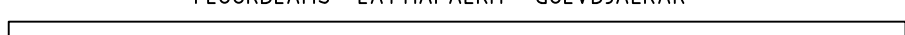

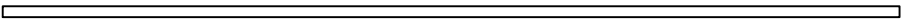
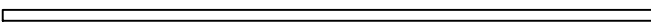

House	P5843-90 Anna	Sheet	13
Drawing	WALL-SEINÄ-VÄGG 3	Scale	1:50
Material	90x160	Date	13.02.2017
Drawer	RP	File	P5843-90 Anna.dwg

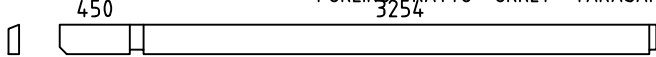
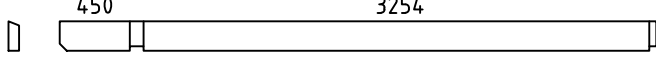
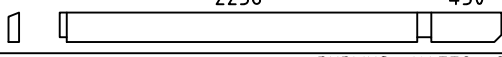
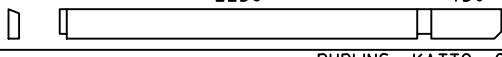
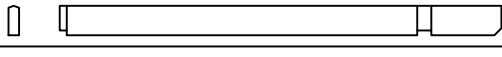



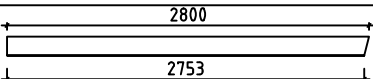















House	P5843-90 Anna	Sheet	14
Drawing	CORNER DECORATION - HÖRN DEKORATION	Scale	1:50
Material		Date	13.02.2017
Drawer	RP	File	P5843-90 Anna.dwg

Pos	P5843-90 Anna	Pcs. St.	Profil(e) (mm)	L (mm)
001		5	90x160	5980
002		1	90x160	5980
003	SPARE BEAM - VARALLAPALKKI - RESERVDEL 	1	90x160	5980
005		10	90x160	4480
006		14	90x160	4480
007		1	90x80	4480
008		PM 1	90x160	4480
009		1	90x160	4480
010		1	90x80	4480
012		2	90x160	3839
013		1	90x80	3839
014		1	90x80	3839
015		9	90x160	3388
017		2	90x160	2841
018		1	90x80	2841
019		1	90x80	2841
020		7	90x160	2675
021		9	90x160	2636
022		1	90x80	2636
023		14	90x160	2636
025		9	90x160	2304
027		2	90x160	1833
030		4	90x160	1640
031		4	90x160	1495
034		1	90x80	1347
House P5843-90 Anna		Material	File P5843-90 Anna.dwg	Sheet 15

Pos	P5843-90 Anna	Pcs. St.	Profil(e) (mm)	L (mm)
035		12	90x160	1347
037		13	90x160	1042
038		4	90x160	998
039		4	90x160	998
041		8	90x160	743
042		1	90x80	743
043		12	90x160	743
044		7	90x160	415
045		4	90x160	411
047		1	90x80	290
048		12	90x160	290
WA-1		1	90x948	4480
WB-1		1	90x948	4480
WC-1		1	90x948	4480
HB	HIT BLOCK-ASENNUSPALKI-SLAG BRÄDA 	2	90x160	300
LB1	LOFT FLOOR BEAMS-PARVIAPALKIT-LOFTBJÄLKAR 	11	43x140	2250
FB1	FLOORBEAMS - LATTIAPALKIT - GOLVBJÄLKAR 	4	70x140	4184
FB2	FLOORBEAMS - LATTIAPALKIT - GOLVBJÄLKAR 	4	70x70	4184
FB5	FLOORBEAMS - LATTIAPALKIT - GOLVBJÄLKAR 	2	43x140	5770
House	P5843-90 Anna	Material	File	P5843-90 Anna.dwg
			Sheet	16

Pos	P5843-90 Anna		Pcs. St.	Profil(e) (mm)	L (mm)
FB3	FLOORBEAMS - LATTIAPALKIT - GOLVBJÄLKAR 		10	43x140	4184
FB6	FLOORBEAMS - LATTIAPALKIT - GOLVBJÄLKAR 		2	43x70	5770
FB4	FLOORBEAMS - LATTIAPALKIT - GOLVBJÄLKAR 		10	43x70	4184
BB2	COUNTERFLOOR HOLDING BOARDS-ROSSIPOHJAA KANNATTELEVAT LAUDAT-BRÄDER SOM HALLER TROSSBOTTEN		10	90x19	4270
BB1	COUNTERFLOOR HOLDING BOARDS-ROSSIPOHJAA KANNATTELEVAT LAUDAT-BRÄDER SOM HALLER TROSSBOTTEN		4	70x19	4270
FS2	SLEEPING FLOOR SUPPORTING SLAT-PARVIALATTIA TUKILISTA -LOFTGOLVLIST		2	43x43	2720
FS1	SLEEPING FLOOR SUPPORTING SLAT-PARVIALATTIA TUKILISTA -LOFTGOLVLIST		2	43x43	1280
RB5	PURLINS - KATTO - ORRET - TAKASAR 450 3254 		2	68x190	3839
RB1	PURLINS - KATTO - ORRET - TAKASAR 450 3254 		2	68x190	3839
RB3	PURLINS - KATTO - ORRET - TAKASAR 450 3254 		1	68x190	3839
RB6	PURLINS - KATTO - ORRET - TAKASAR 2256 450 		2	68x190	2841
RB2	PURLINS - KATTO - ORRET - TAKASAR 2256 450 		2	68x190	2841
RB4	PURLINS - KATTO - ORRET - TAKASAR 2256 450 		1	68x190	2841
F1	FLOORBOARD - LATTIALAUTA - GOLVBRÄDE	 114 or-tai-eller 88	36+1 47+1	114x28 88x28	3250
F2	FLOORBOARD - LATTIALAUTA - GOLVBRÄDE	 114 or-tai-eller 88	36+1 47+1	114x28 88x28	2250
L1	LOFT BOARD - PARVIALATTIA - LOFTGOLV	 114 or-tai-eller 88	20+1 26+1	114x19 88x19	4095
R1	ROOFBOARD - KATTOLAUTA - TAKBRÄDE	 114 or-tai-eller 88	118+2 154+2	114x19 88x19	2750
FF1	SKIRTING SLAT - LATTIALISTA - GOLVLIST			19x35	47 m
GB1	GABLE BOARD - KAAPELILAUTA - GAVELBRÄDA 		4	19x120	2800
GS1	BOARD MATCHING WITH GABLE BOARD-KAAPELILAUTA VASTAVA LAUTA-BRÄDA OVANPÅ GAVELBRÄDA		4	19x70	2800
EB1	EAVE BOARD - RÄYSTÄSLAUTA - TAKFOTBRÄDE		4	19x90	3340
ES1	EAVE SLAT - RÄYSTÄSLISTA - TAKFOTLIST		4	30x40	3340
DB1	DECORATIVE - KORISTE - PRYDNADS		2	19x90	200
CDB1	CORNER DECORATION BOARD- HÖRN DEKORATION BRÄDE		22	120x19	2790
CDB2	CORNER DECORATION BOARD- HÖRN DEKORATION BRÄDE		3	90x19	2790
House	P5843-90 Anna	Material	File	P5843-90 Anna.dwg	Sheet 17

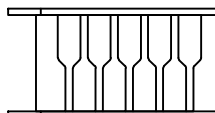
Pos	P5843-90 Anna		Pcs. St.	Profil(e) (mm)	L (mm)	
CDB3	CORNER DECORATION BOARD- HÖRN DEKORATION BRÄDE		16	70x19	2790	
CB1	COVERING BOARD-PEITELAUTA-HYLLBRÄDA		1	19x120	1580	
SB1	SUPPORT BOARD-TUKILAUTA-KONSOL		2	19x79	155	
DT1	DOOR ASSEMBLING PROFILE-OVEN ASENNUSPROFIILI -DÖRR MONTERINGSPROFIL		4	43x90	2040	
DT2	DOOR ASSEMBLING PROFILE-OVEN ASENNUSPROFIILI -DÖRR MONTERINGSPROFIL		4	43x90	1950	
WT1	WINDOW ASSEMBLING PROFILE-IKKUNA ASENNUSPROFIILI -FÖNSTER MONTERINGSPROFIL		2	43x90	1050	
WT2	WINDOW ASSEMBLING PROFILE-IKKUNA ASENNUSPROFIILI -FÖNSTER MONTERINGSPROFIL		8	43x90	590	
FLT1	ASSEMBLING PROFILE-ASENNUSPROFIILI-MONTERINGSPROFIL		2	25x19	760	
SJ1	SCREW JOINT-KIERRETANKO-GÄNGSTAPP		6	ØM10	2770	
RCM	ROOFBEAMS CONNECTING METAL-METALL FÖR SAMMANFOGNING AV TAKASAR-KATTO-ORRE YHTEENLITYSMETALLT		5	Ø6	200	
WCM	WALLBEAMS CONNECTING METAL-METALLPLATTA FÖR SAMMANFOGNING AV VÄGGEN BALKAR-SEINÄPALKKEJA METALLISET YHTEENLIITYMISLAATAT		2	60	60	
	NAILS-NAULAT-SPIKAR FOR-VARTEN-FÖR	FF1		110	Ø2.0	40
	NAILS-NAULAT-SPIKAR FOR-VARTEN-FÖR	F1, F2, L1, R1, BB1, BB2		1600	Ø2.5	60
	SCREWS-RUUVIT-SKRUVAR FOR-VARTEN-FÖR	WCM, CDB3		100	Ø3.5	35
	SCREWS-RUUVIT-SKRUVAR FOR-VARTEN-FÖR	GB1, GS1, EB1, ES1, DB1 C, CDB1, CDB2		280	Ø4.5	50
	SCREWS-RUUVIT-SKRUVAR FOR-VARTEN-FÖR	FS1, LB1, LB2, S		50	Ø4.5	70
	SCREWS-RUUVIT-SKRUVAR FOR-VARTEN-FÖR	FB1, FB2, FB3, FB4, FB5, FB6		60	Ø4.5	90
	SCREWS-RUUVIT-SKRUVAR FOR-VARTEN-FÖR	007, 010, 013, 014, 018, 019, 022 034, 042, 047, FB2, FB4, FB6		80	Ø5.0	120
	SCREWS-RUUVIT-SKRUVAR FOR-VARTEN-FÖR	RB1, RB2, RB3, RB4, RB5, RB6		20	Ø6.0	160
LD1	LADDER-TIKAPUUT-STEGE		1	700	2760	
House	P5843-90 Anna	Material	File	P5843-90 Anna.dwg	Sheet 18	

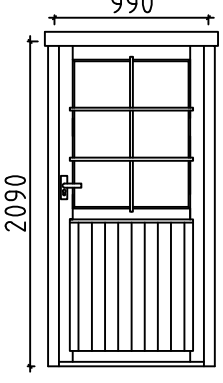
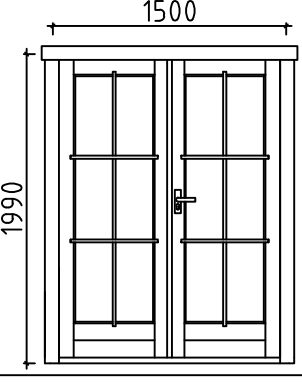
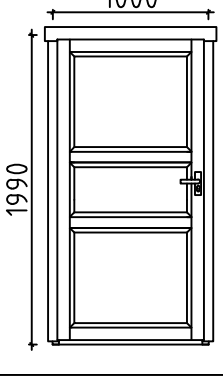
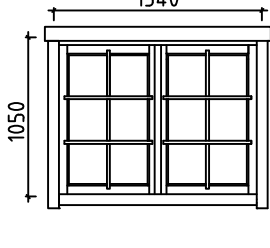
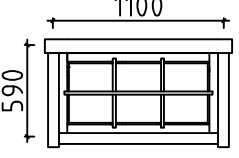
Pos	P5843-90 Anna	Pcs. St.	Profil(e) (mm)	L (mm)		
D1	DOOR-OVI-DÖRR (right-oikea-höger) ORT_ST 	P 1 1 1 1	990	2090		
D2	DOOR-OVI-DÖRR (right-oikea-höger) ORT_ST 	P 1 1 1 2	1500	1990		
D3	DOOR-OVI-DÖRR (left-jäljellä-vänster) AST 	V 2 2	1000	1990		
W1	WINDOW-IKKUNAN-FÖNSTER (right-oikea-höger) ORT_ST 	P 1 2 1	1340	1050		
W2	WINDOW-IKKUNAN-FÖNSTER ORT_ST_SU 	P 2 2 2	1100	590		
House	P5843-90 Anna	Material	File	P5843-90 Anna.dwg	Sheet	19

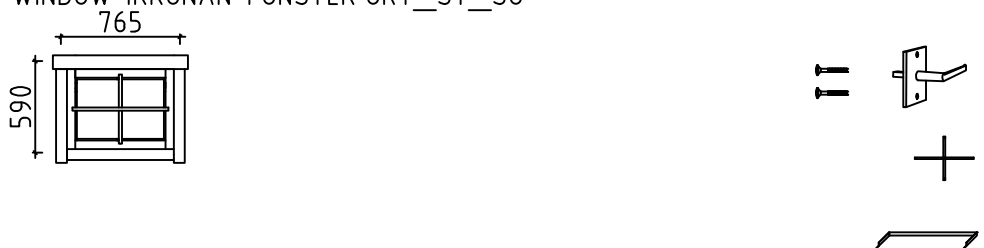
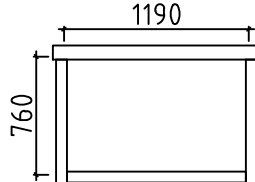
Pos	P5843-90 Anna	Pcs. St.	Profil(e) (mm)	L (mm)
W3	WINDOW-IKKUNAN-FÖNSTER (right-oikea-höger) ORT_ST 	1 1 1 1	590	590
W4	WINDOW-IKKUNAN-FÖNSTER ORT_ST_SU 	1 1 1 1	765	590
FL1	FRAME AROUND LOFT ENTRANCE 	1	1190	760
House	P5843-90 Anna	Material	File	20

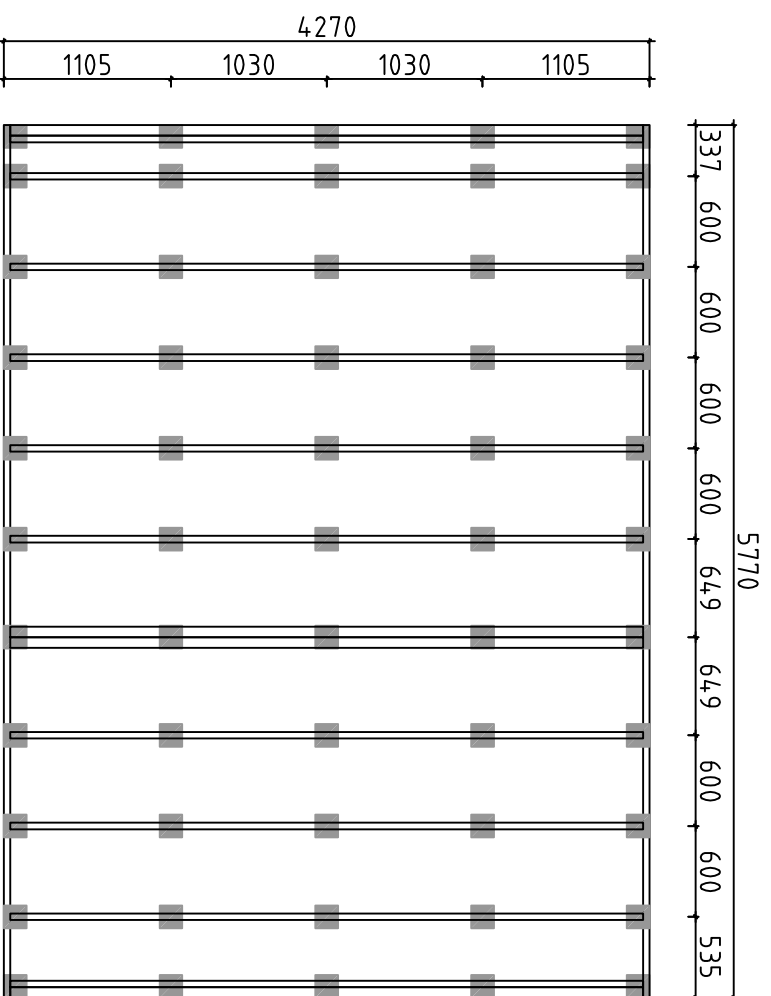

Detta är ett förslag för hur man kan placera plintarna (100-200 mm i diameter) för golvbjälklaget. Golvbjälkarna är med i byggsatsen, men inte plintarna. Använder man exempelvis 500-600mm långa murblock så kan man halvera antalet punkter. Lägg fuktskyddande papp mellan betong och trä

Tämä on ehdotus siitä, miten (100-200 mm läpimittaiset) jalat voidaan sijoittaa alapohjaa varten. Lattiapalkit ovat rakennussarjassa, mutta jalkoja ei ole. Kun käytetään esimerkiksi 500-600 mm pitkiä harkkoja, voidaan pisteiden määrä puoltaa. Aseta betonin ja puun väliin kosteudelta suojaava pähvi

A proposal for placing plinths (100-200 mm in diameter) for floor beams. Floor beams are provided in the kit but plinths are not included. For example, by using 500-600 mm long masonry units, one can reduce the number of points 50%. Place cardboard between the concrete and wood to protect from moisture

House	P5843-90 Anna	Sheet	21
Drawing	FOUNDATION PLAN - PLINTPLAN	Scale	1:50
Material		Date	13.02.2017
Drawer	RP	File	P5843-90 Anna Foundation.dwg

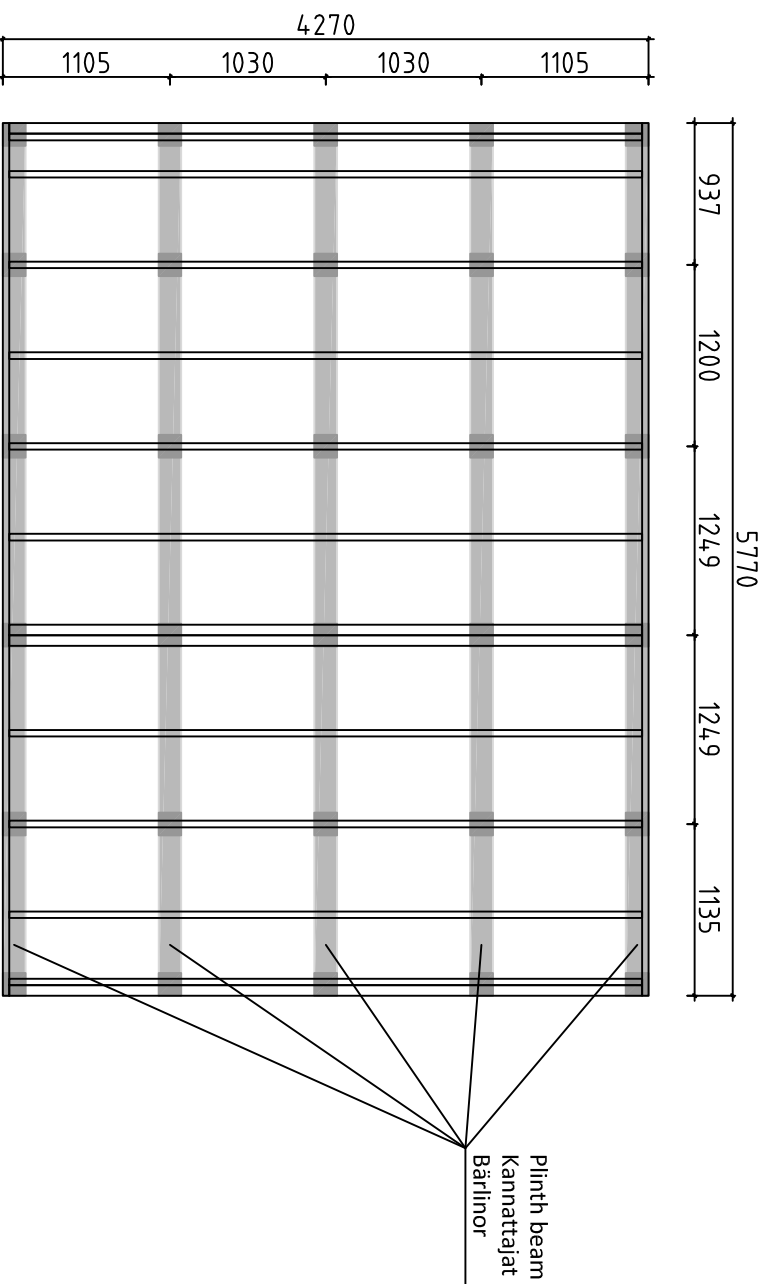

Förslag på alternativ plintplan med bärlinor och plintar. Bärlinor 45x95 eller 45x120 och plintar ca 100-200 mm i diameter. (Bärlinor och plintar ingår ej i leveransen). Används exempelvis murblock, (ingår ej i leveransen) istället för plintar, kan man lägga bärlinorna platt mot dessa och på det sättet minska höjden på konstruktionen. I denna konstruktion kan man dessutom lägga en "boardskiva" mellan bärlinorna och golvbjälkarna och på det sättet bära upp bjälklagsisoleringen. Lagg fuktskyddande papp mellan betong och trä

Endotus valtoehtoisestä jalustasta kannattajilla ja jalloilla. Kannattajat 45x95 tai 45x120 ja jalat läpimitataan n. 100-200 mm (kannattajat ja jalat ei ole toimituksessa). Käytettäessä esimerkiksi harkkoja (ei kuulu toimitukseen) jalkojen sijasta, voi kannattajat asettaa lappeelleen niitä vasten ja sillä tavoin vähentää rakenteen korkeutta. Tässä rakenteessa voi lisäksi asettaa levyä kannattajien ja lattiapalkkien väliin ja sillä tavoin kannattaa alapohjan eristystä. Aseta betonin ja puun väliin kosteudelta suojaava pahvi

A proposal for alternative plinth beam layout plan. Plinth beams 45x95 or 45x120 and plinths ca 100-200 mm in diameter (plinth beams and plinths are not included in the kit). For example, by using masonry units (not included in the kit) instead of plinths, one can lay plinth beams flat against the masonry units and in that way reduce the height of the structure. In this construction one can also add "plywood board" between plinth beams. Place cardboard between the concrete and wood to protect from moisture

House	P5843-90 Anna	Sheet	22
Drawing	FOUNDATION PLAN - PLINTPLAN	Scale	1:50
Material		Date	13.02.2017
Drawer	RP	File	P5843-90 Anna Foundation.dwg

#001	1,3	5980	5
#002	1	5980	1
#003		5980	1
#004	A	4480	1
#005	A,C	4480	10
#006	C	4480	14
#007	C	4480	1
#008	B	4480	1
#009	B	4480	1
#010	A	4480	1
#011	A	4100	1
#012	1,3	3839	2
#013	3	3839	1
#014	1	3839	1
#015	3	3388	9
#016	A	3022	1
#017	1,3	2841	2
#018	3	2841	1
#019	1	2841	1
#020	A	2675	7
#021	1	2636	9
#022	2	2636	1
#023	2	2636	14
#024	A,B,C	2460	3
#025	1	2304	9
#026	C	1833	2
#027	C	1833	2
#028	C	1643	2
#029	B	1640	2
#030	B	1640	4
#031	3	1495	4
#032	B	1450	2
#033	A,B,C	1382	3
#034	B	1347	1
#035	B	1347	12
#036	C	1104	2
#037	3	1042	13
#038	1	998	4
#039	1	998	4
#040	B	911	2
#041	1,3	743	8
#042	B	743	1
#043	B	743	12
#044	A	415	7
#045	1	411	4
#046	A,B,C	380	6
#047	B	290	1
#048	B	290	12
#049	A,B,C	69	12