

Date rev. Description

House	P584.3-70 Diana	Sheet	1
-------	-----------------	-------	---

Drawing	3D	Scale	
---------	----	-------	--

Material	70x135	Date	05.01.2017
----------	--------	------	------------

Drawer	RP	File	P584.3-70 Diana 3D.dwg
--------	----	------	------------------------

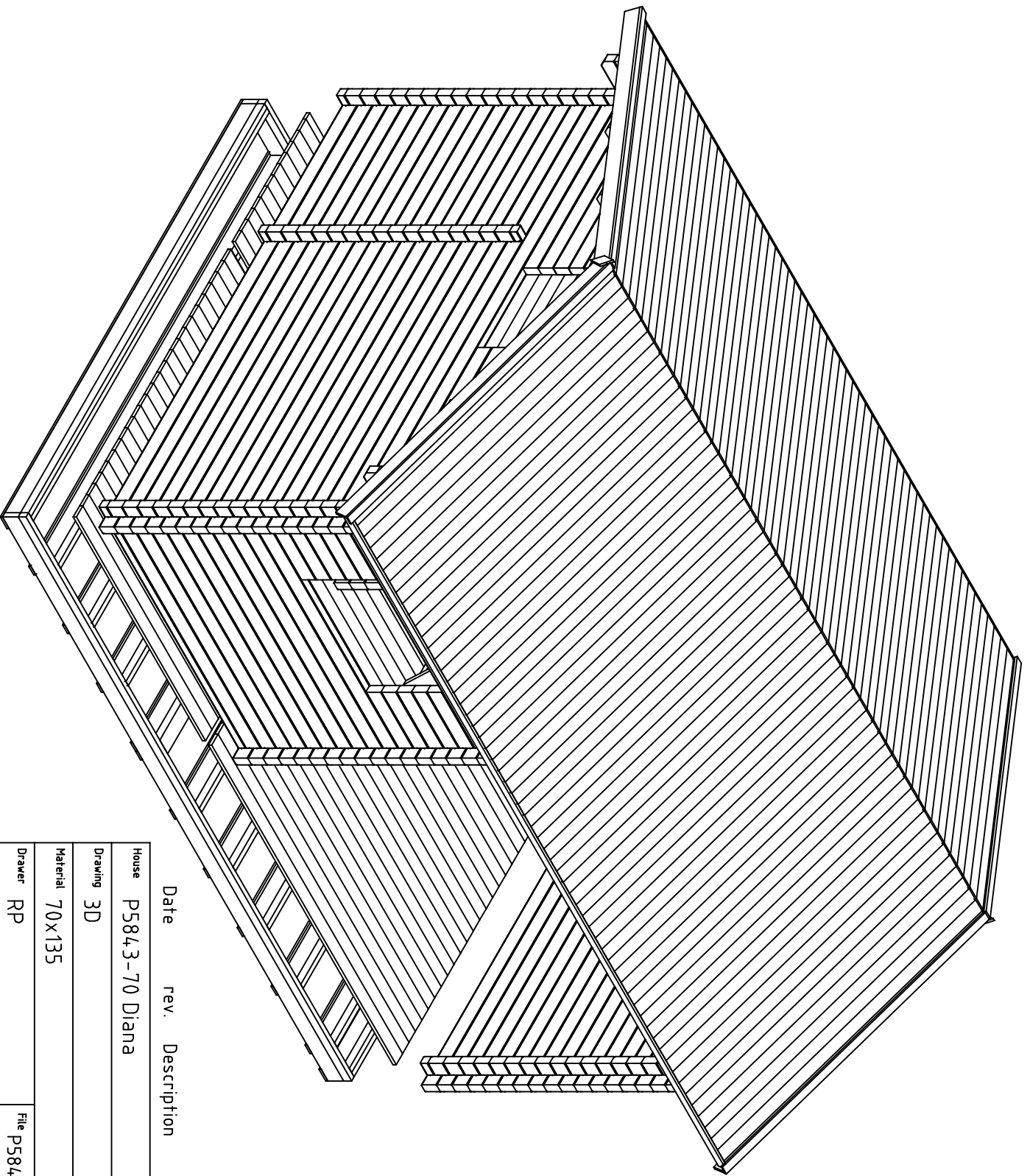

Date rev. Description

House	P5843-70 Diana	Sheet	2
-------	----------------	-------	---

Drawing	3D	Scale	
---------	----	-------	--

Material	70x135	Date	05.01.2017
----------	--------	------	------------

Drawer	RP	File	P5843-70 Diana 3D.dwg
--------	----	------	-----------------------

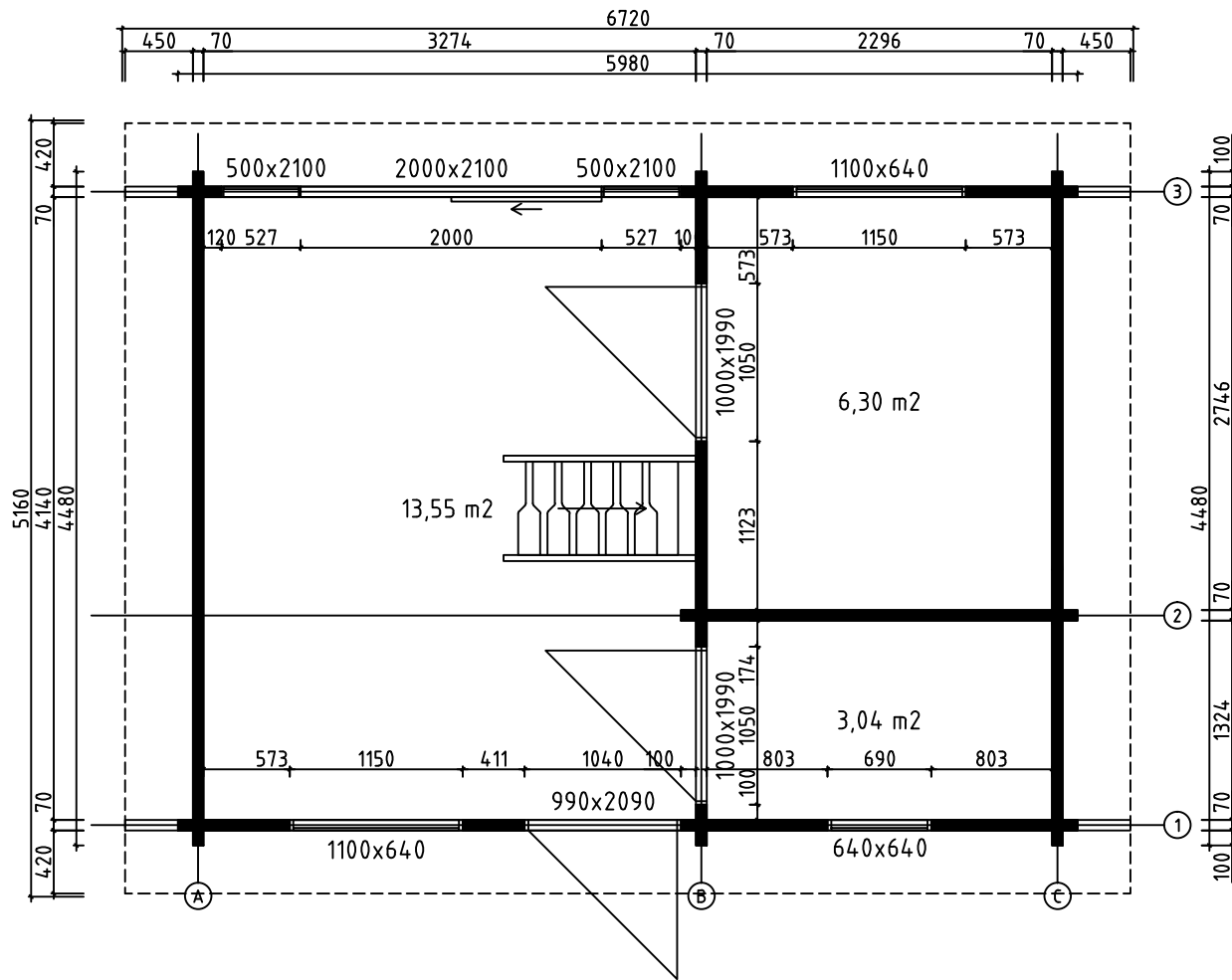

House	P5843-70 Diana	Sheet	3
Drawing	PLAN-SUUNNITELMA-PLANEN	Scale	1:50
Material	70x135	Date	05.01.2017
Drawer	RP	File	P5843-70 Diana.dwg

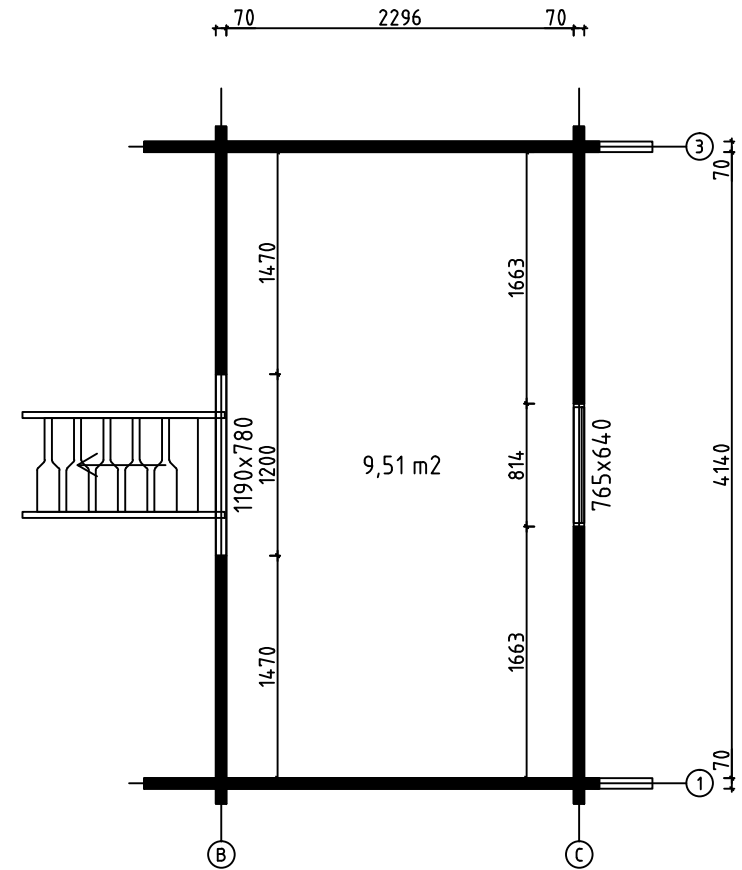
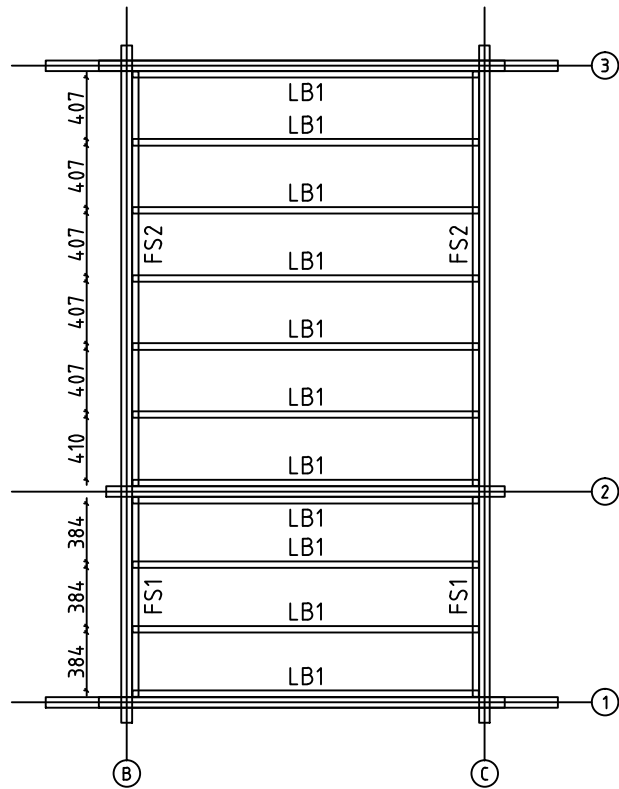

LOFT FLOOR BEAMS - PARVIA LATTIAPALKIT - LOFT GOLVBJÄLKAR

House	P5843-70 Diana	Sheet	4
Drawing	LOFT FLOOR - PARVIA LATTIA - LOFT GOLV	Scale	1:50
Material	43x43, 43x140 70x135	Date	05.01.2017
Drawer	RP	File	P5843-70 Diana.dwg

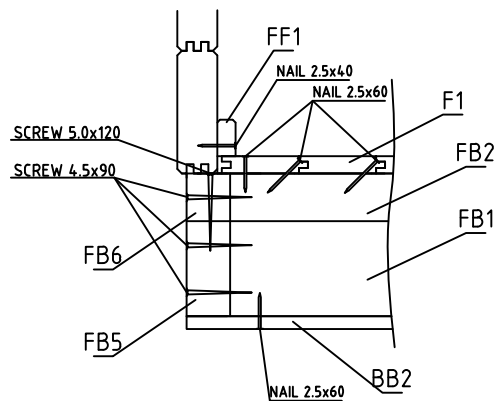
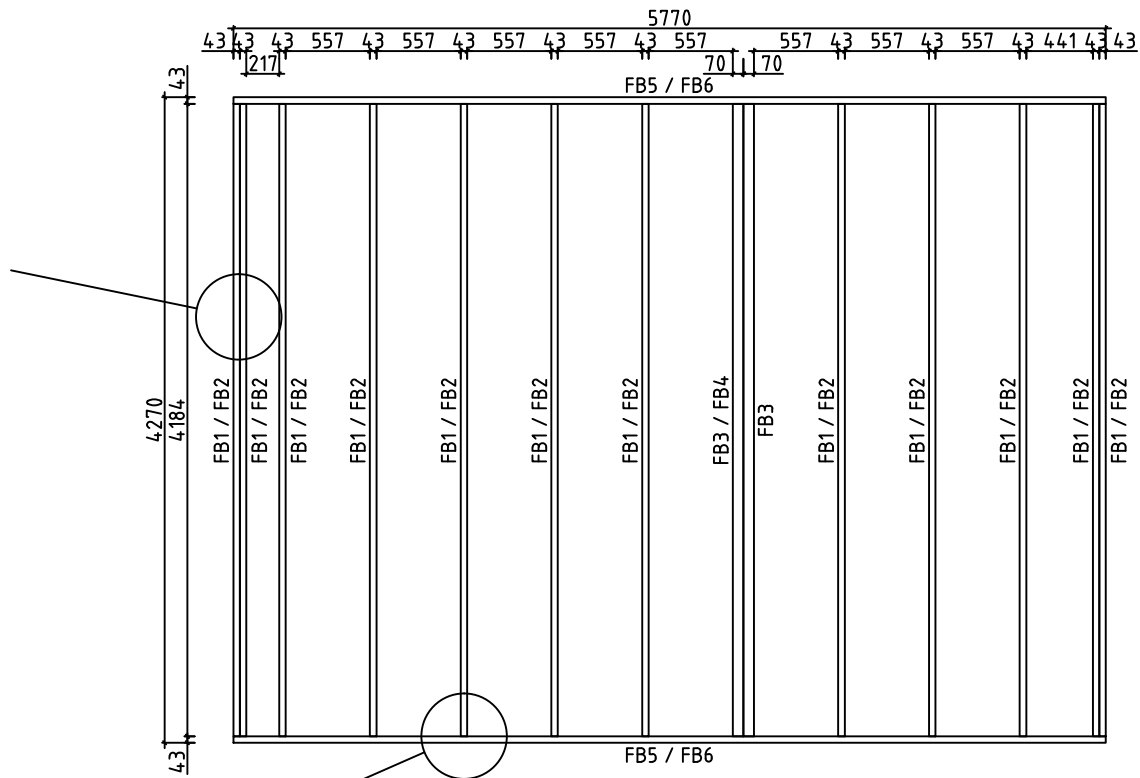
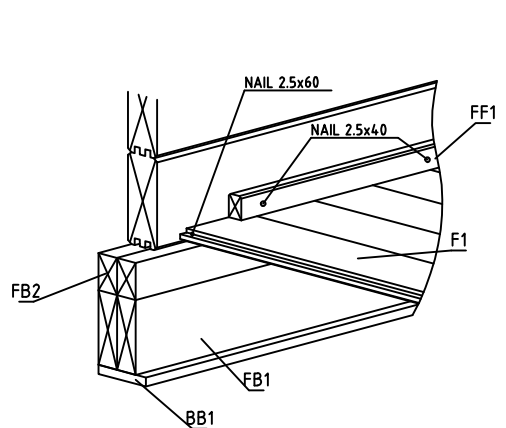

House	P5843-70 Diana	Sheet	5
Drawing	FLOORBEAMS-LATTIAPALKIT-GOLVBJÄLKAR	Scale	1:50
Material	70x140, 43x140, 43x70	Date	05.01.2017
Drawer	RP	File	P5843-70 Diana.dwg

F1

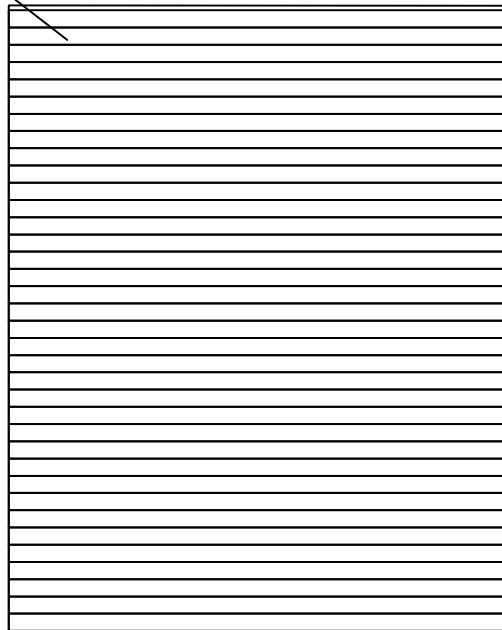

F2

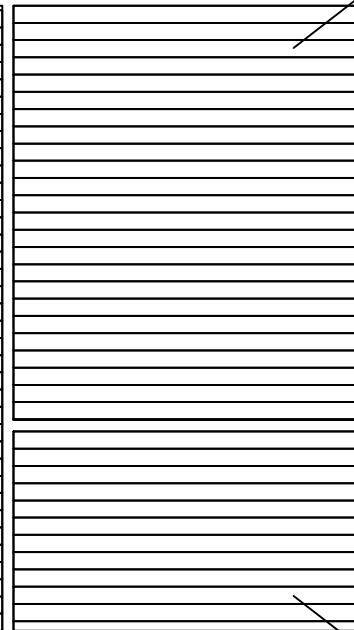

F2

FLOORBOARD-LATTIALAUTA-GOLVBRÄDE (114x28)

L1

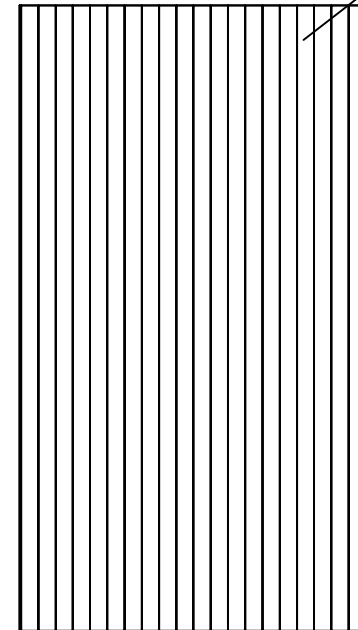

LOFT FLOORBOARD - PARVIA LATTIALATTIA - LOFT GOLVBRÄDE (114x19)

House	P5843-70 Diana	Sheet	6
Drawing	FLOORBOARD-LATTIALAUTA-GOLVBRÄDE	Scale	1:50
Material	114x28, 114x19	Date	05.01.2017
Drawer	RP	File	P5843-70 Diana.dwg

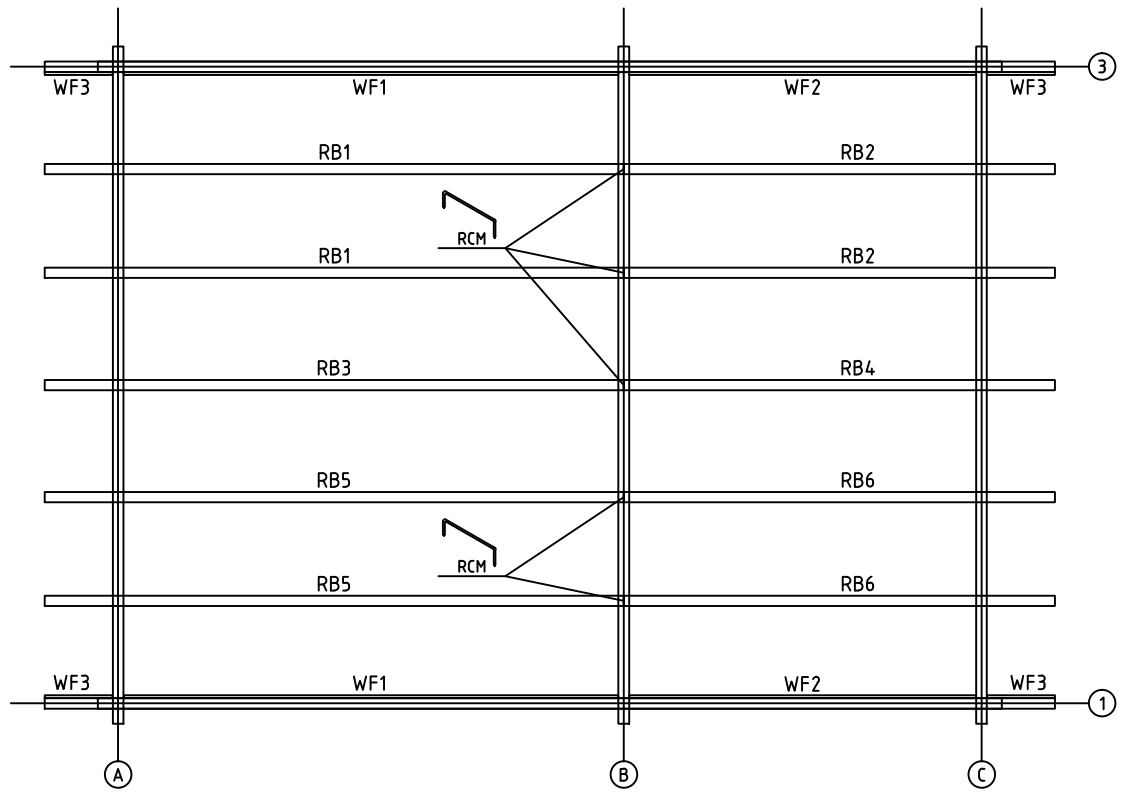

House	P5843-70 Diana	Sheet	7
Drawing	PURLINS-KATTO-ORRET-TAKÅSAR	Scale	1:50
Material	68x190, 19x90	Date	05.01.2017
Drawer	RP	File	P5843-70 Diana.dwg

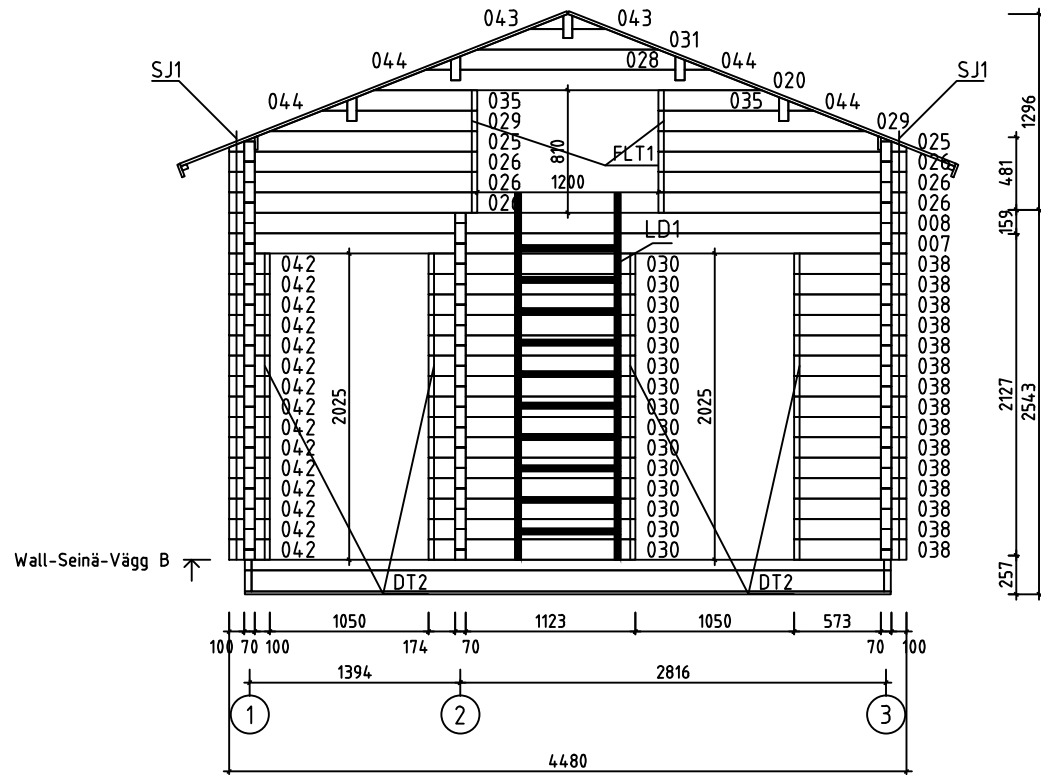

House	P5843-70 Diana	Sheet	9
Drawing	WALL-SEINÄ-VÄGG B	Scale	1:50
Material	70x135	Date	05.01.2017
Drawer	RP	File	P5843-70 Diana.dwg

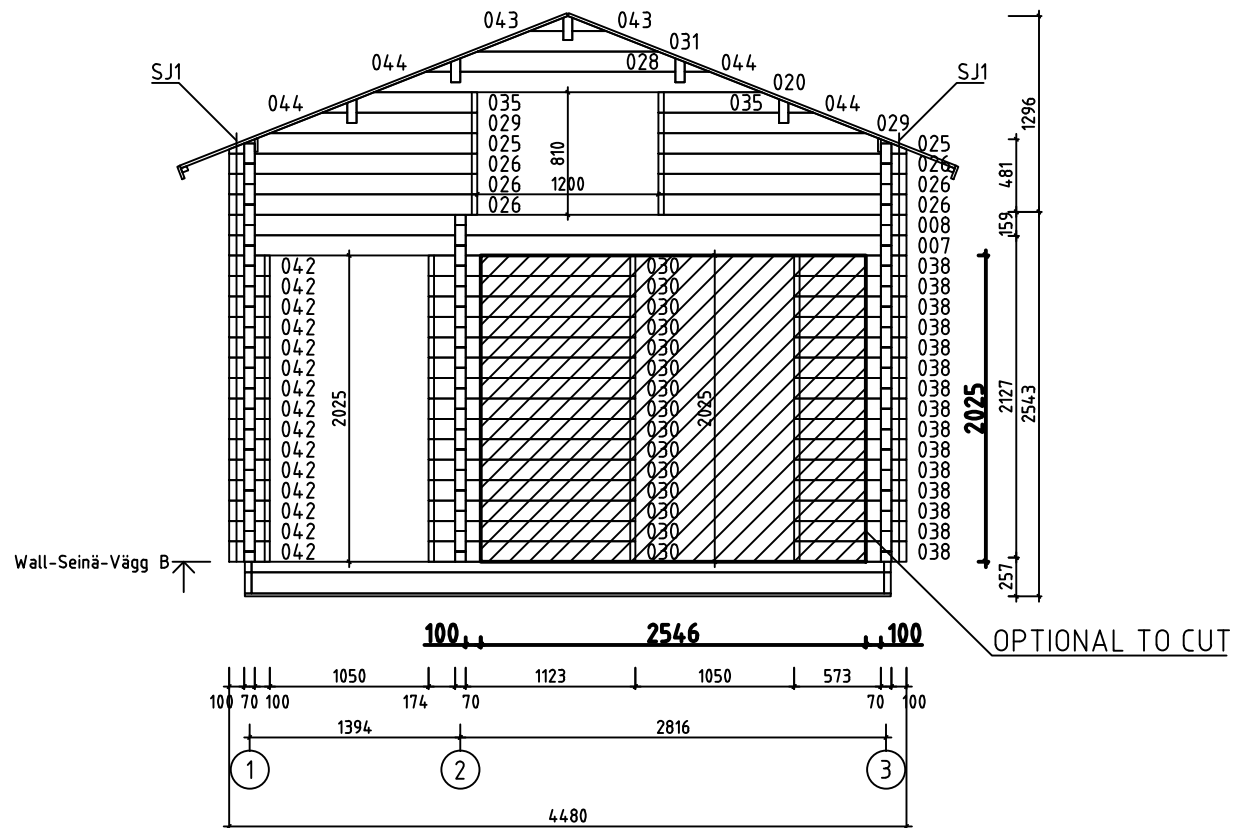

House	P5843-70 Diana	Sheet	9A
Drawing	WALL-SEINÄ-VÄGG B	Scale	1:50
Material	70x135	Date	05.01.2017
Drawer	RP	File	P5843-70 Diana Optional.dwg

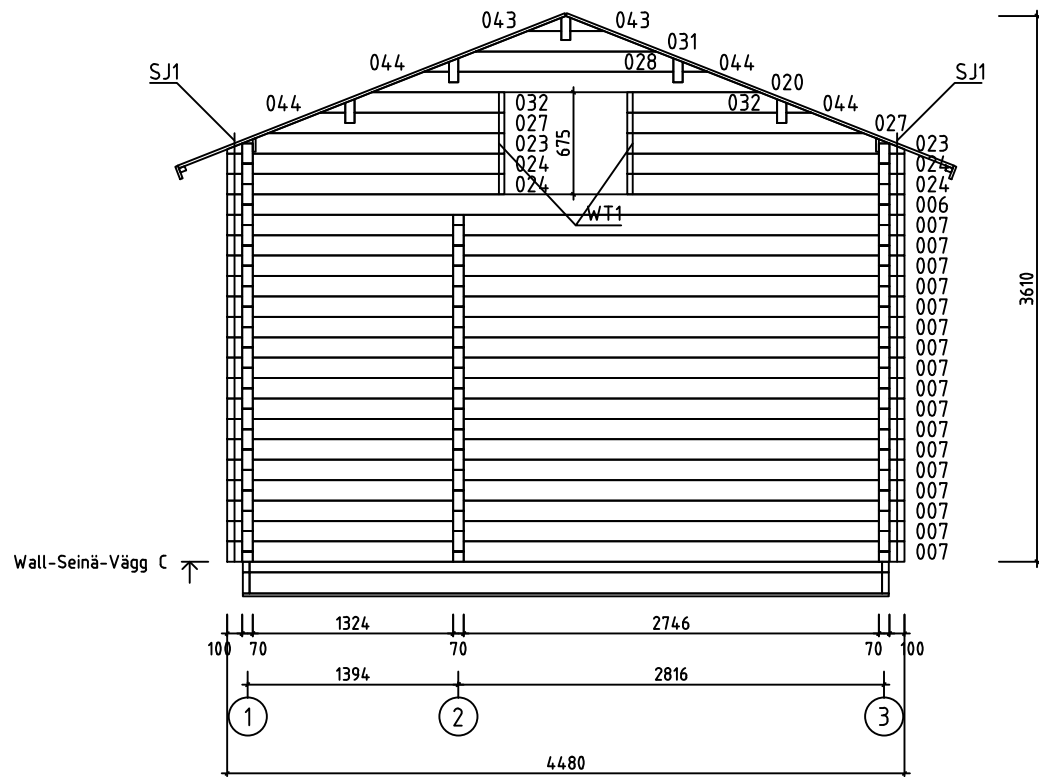

House	P5843-70 Diana	Sheet	10
Drawing	WALL-SEINÄ-VÄGG C	Scale	1:50
Material	70x135	Date	05.01.2017
Drawer	RP	File	P5843-70 Diana.dwg

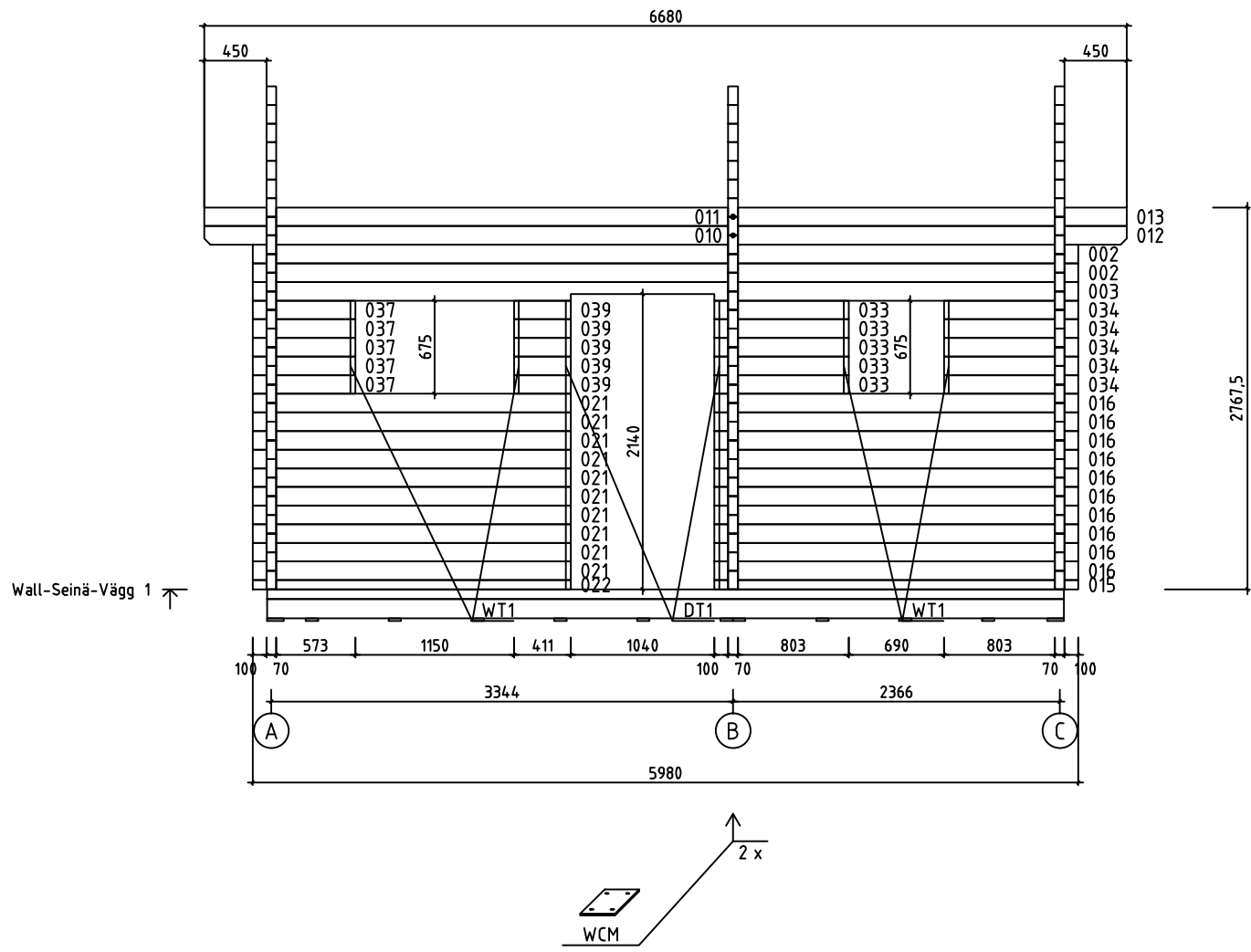



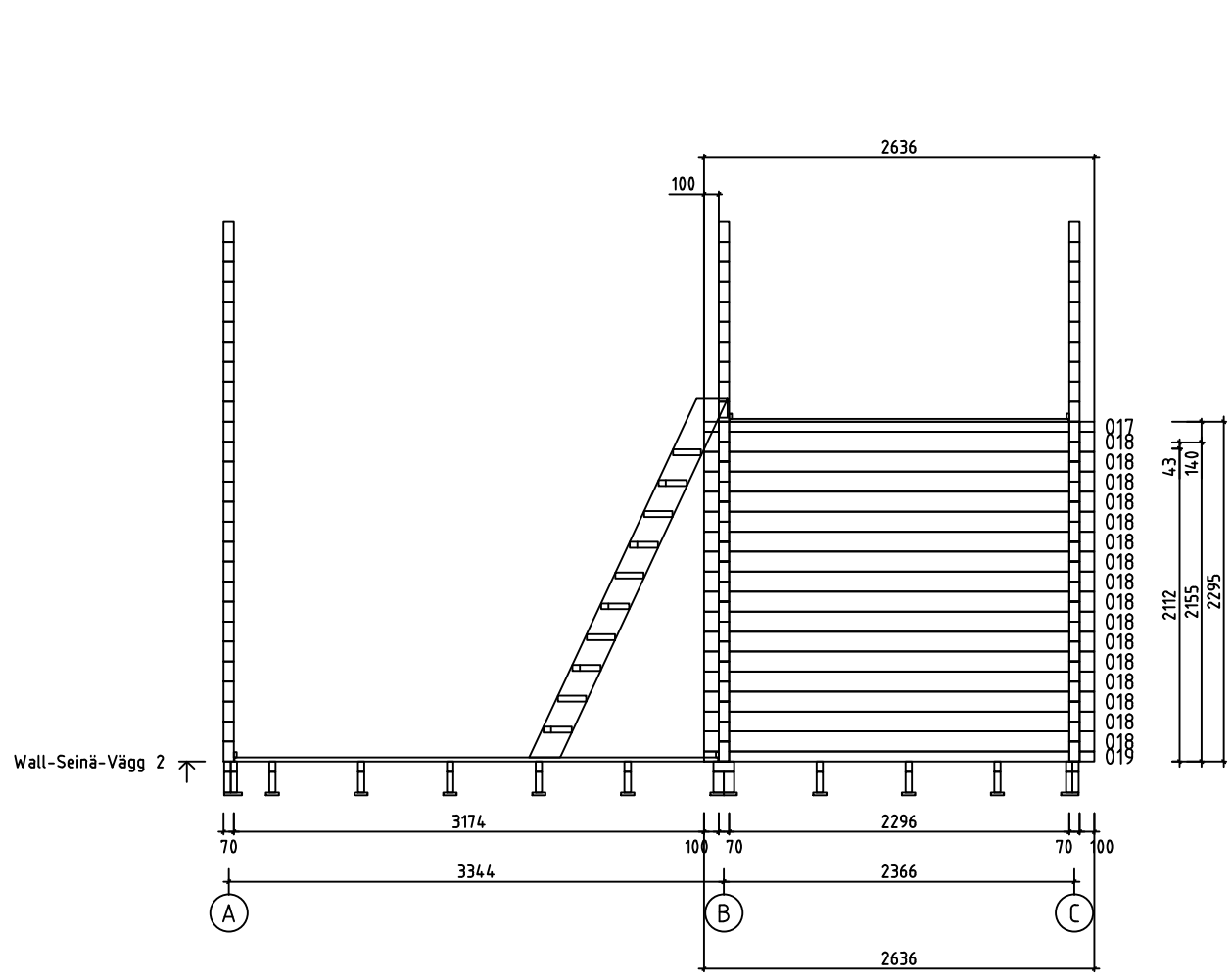

House	P5843-70 Diana	Sheet	11
Drawing	WALL-SEINÄ-VÄGG 1	Scale	1:50
Material	70x135	Date	05.01.2017
Drawer	RP	File	P5843-70 Diana.dwg

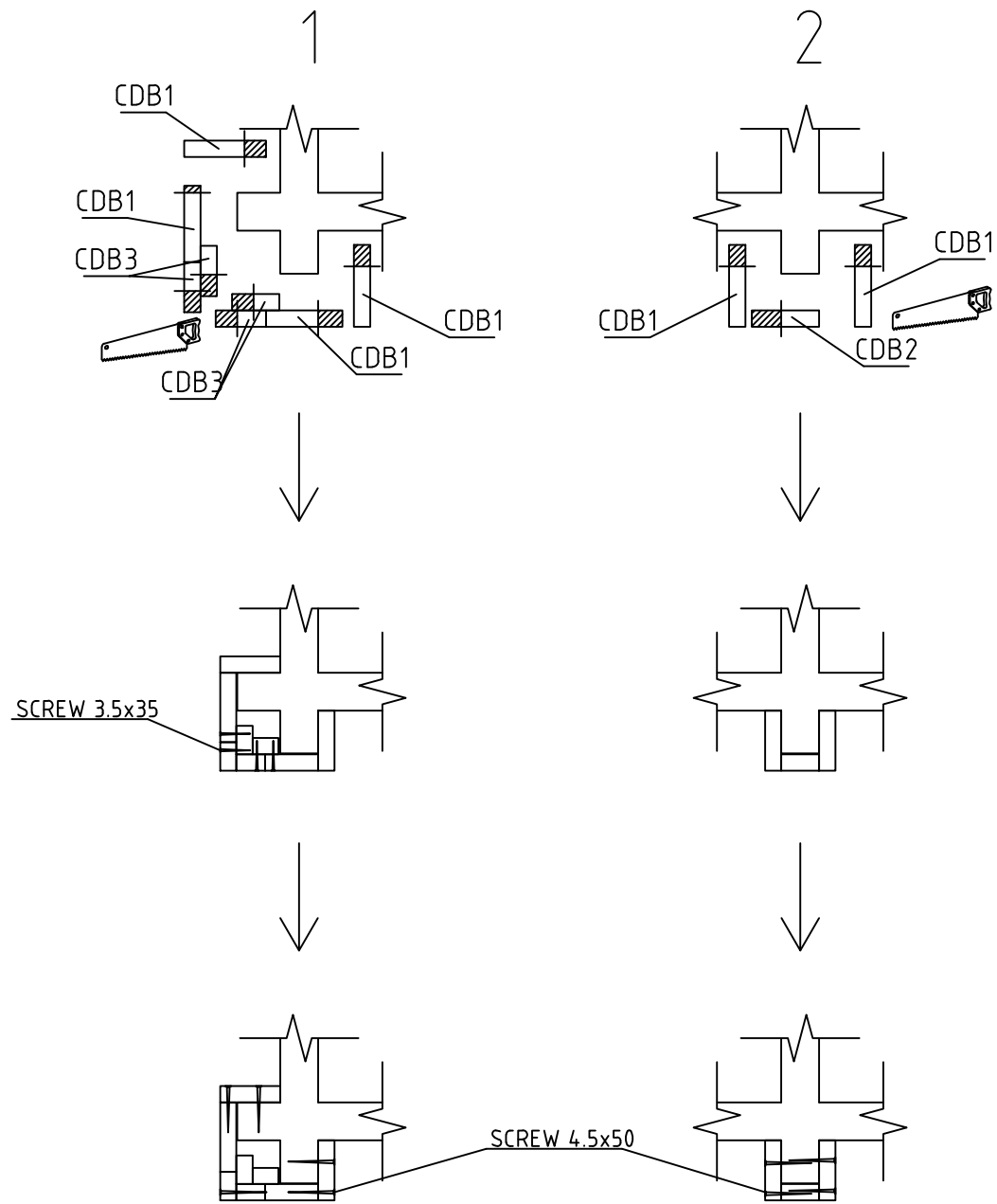
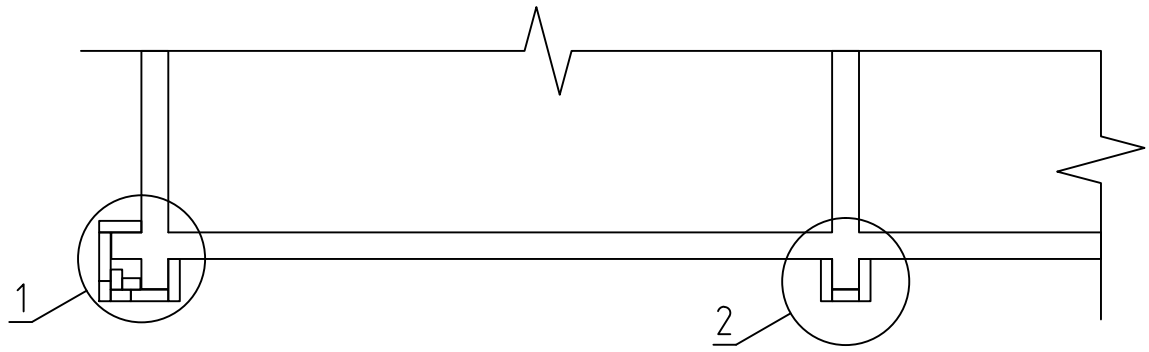



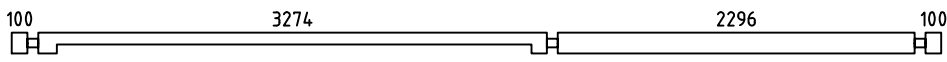
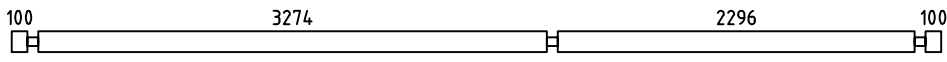
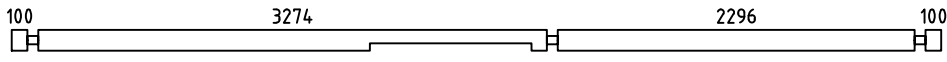
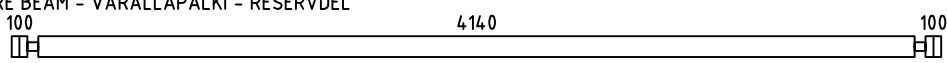
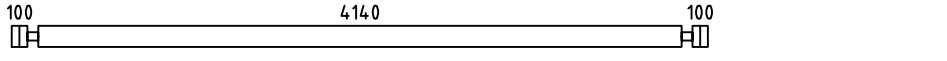
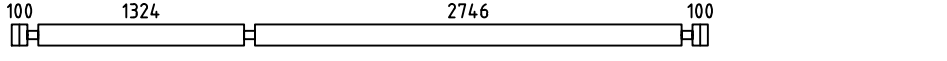
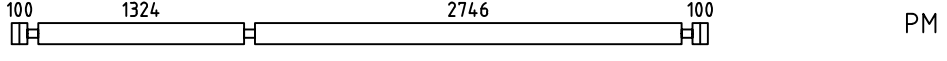
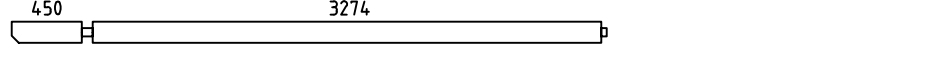
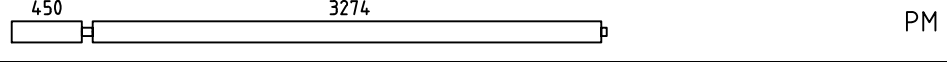

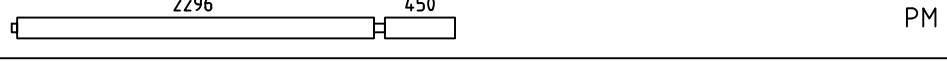
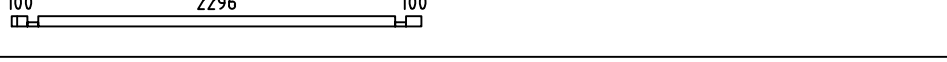
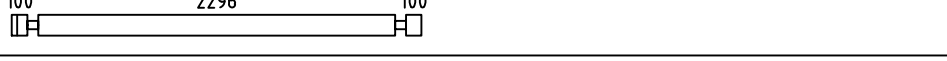
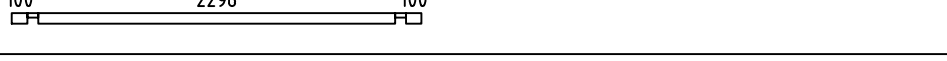
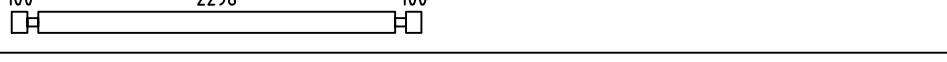

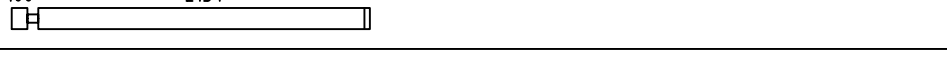
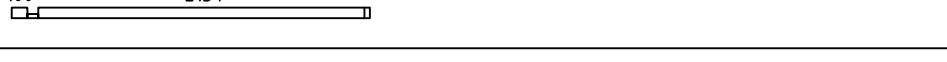
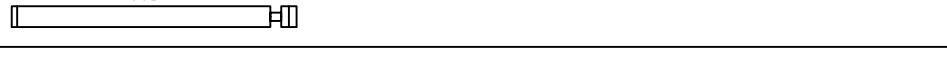
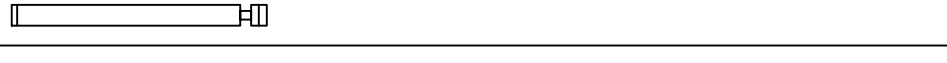
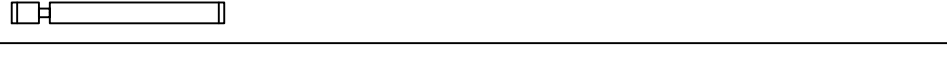
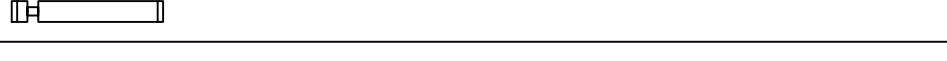
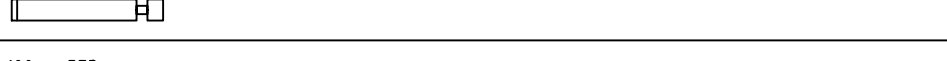
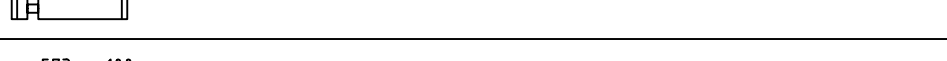
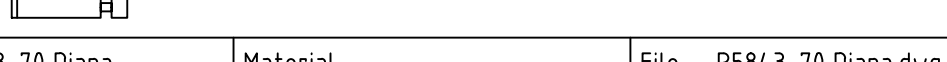

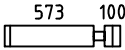



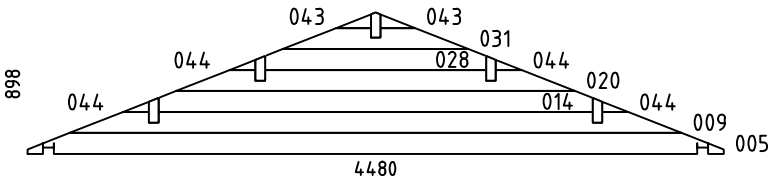
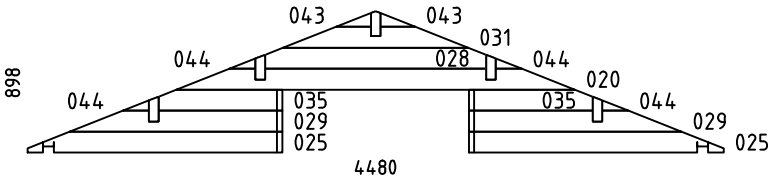
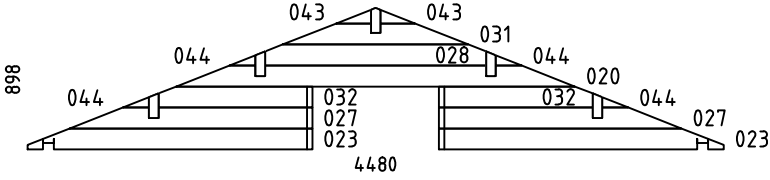

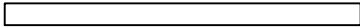
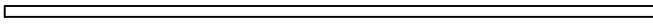
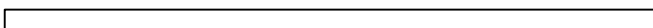
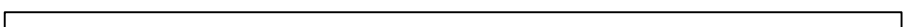
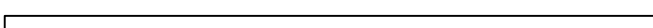
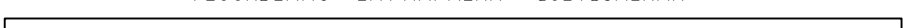
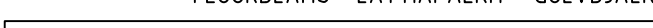





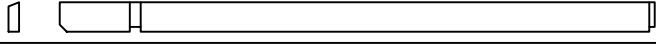
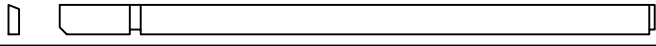
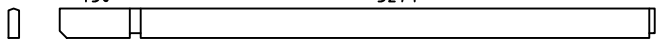
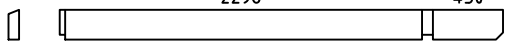
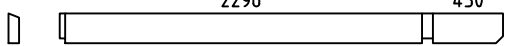
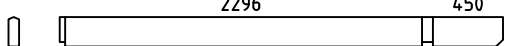





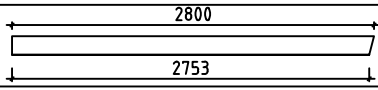

House	P5843-70 Diana	Sheet	12
Drawing	WALL-SEINÄ-VÄGG 2	Scale	1:50
Material	70x135	Date	05.01.2017
Drawer	RP	File	P5843-70 Diana.dwg



















House	P5843-70 Diana	Sheet	14
Drawing	CORNER DECORATION - HÖRN DEKORATION	Scale	1:50
Material		Date	05.01.2017
Drawer	RP	File	P5843-70 Diana.dwg

Pos	P5843-70 Diana	Pcs. St.	Profil(e) (mm)	L (mm)
001		1	70x135	5980
002		4	70x135	5980
003		1	70x135	5980
004	SPARE BEAM - VARALLAPALKI - RESERVDEL 	1	70x135	5980
006		21	70x135	4480
007		18	70x135	4480
008		PM 1	70x135	4480
010		2	70x135	3829
011		PM 2	70x135	3829
012		2	70x135	2851
013		PM 2	70x135	2851
015		2	70x68	2636
016		20	70x135	2636
017		1	70x68	2636
018		16	70x135	2636
019		1	70x68	2636
021		10	70x135	2304
022		1	70x68	2304
024		4	70x135	1833
026		6	70x135	1640
030		15	70x135	1367
033		5	70x135	973
034		5	70x135	973
036		5	70x135	743
037		10	70x135	743
House P5843-70 Diana		Material	File P5843-70 Diana.dwg	Sheet 15

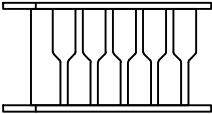
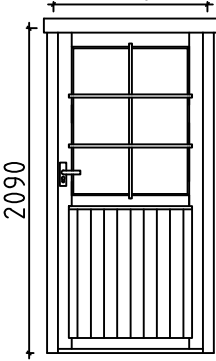
Pos	P5843-70 Diana	Pcs. St.	Profil(e) (mm)	L (mm)		
038		15	70x135	743		
039		5	70x135	411		
040	100120 	15	70x135	290		
041	100120 	1	70x68	290		
042	100100 	15	70x135	270		
WA-1		1	70x898	4480		
WB-1		1	70x898	4480		
WC-1		1	70x898	4480		
HB	HIT BLOCK-ASENNUSPALKI-SLAG BRÄDA 	2	70x135	300		
LB1	LOFT FLOOR BEAMS-PARVIAPALKIT-LOFTBJÄLKAR 	11	43x140	2290		
FB4	FLOORBEAMS - LATTIAPALKIT - GOLVBJÄLKAR 	1	140x70	4184		
FB3	FLOORBEAMS - LATTIAPALKIT - GOLVBJÄLKAR 	2	70x140	4184		
FB5	FLOORBEAMS - LATTIAPALKIT - GOLVBJÄLKAR 	2	43x140	5770		
FB1	FLOORBEAMS - LATTIAPALKIT - GOLVBJÄLKAR 	12	43x140	4184		
FB6	FLOORBEAMS - LATTIAPALKIT - GOLVBJÄLKAR 	2	43x70	5770		
FB2	FLOORBEAMS - LATTIAPALKIT - GOLVBJÄLKAR 	12	43x70	4184		
FS2	SLEEPING FLOOR SUPPORTING SLAT-PARVIALATTIA TUKILISTA -LOFTGOLVLIST 	2	43x43	2740		
FS1	SLEEPING FLOOR SUPPORTING SLAT-PARVIALATTIA TUKILISTA -LOFTGOLVLIST 	2	43x43	1320		
BB1	COUNTERFLOOR HOLDING BOARDS-ROSSIPOHJAA KANNATTELEVAT LAUDAT-BRÄDER SOM HALLER TROSSBOTTEN 	2	120x19	4270		
House	P5843-70 Diana	Material	File	P5843-70 Diana.dwg	Sheet	16

Pos	P5843-70 Diana		Pcs. St.	Profil(e) (mm)	L (mm)
BB2	COUNTERFLOOR HOLDING BOARDS-ROSSIPOHJAA KANNATTELEVAT LAUDAT-BRÄDER SOM HALLER TROSSBOTTEN		10	90x19	4270
RB5	PURLINS - KATTO - ORRET - TAKASAR 450 3274		2	68x190	3829
RB1	PURLINS - KATTO - ORRET - TAKASAR 450 3274		2	68x190	3829
RB3	PURLINS - KATTO - ORRET - TAKASAR 450 3274		1	68x190	3829
RB6	PURLINS - KATTO - ORRET - TAKASAR 2296 450		2	68x190	2851
RB2	PURLINS - KATTO - ORRET - TAKASAR 2296 450		2	68x190	2851
RB4	PURLINS - KATTO - ORRET - TAKASAR 2296 450		1	68x190	2851
F1	FLOORBOARD - LATTIALAUTA - GOLVBRÄDE	 114 or -tai- eller 88	37+1 48+1	114x28 88x28	3270
F2	FLOORBOARD - LATTIALAUTA - GOLVBRÄDE	 114 or -tai- eller 88	37+1 48+1	114x28 88x28	2290
L1	LOFT BOARD - PARVIALATTIA - LOFTGOLV	 114 or -tai- eller 88	21+1 28+1	114x19 88x19	4135
R1	ROOFBOARD - KATTOLAUTA - TAKBRÄDE	 114 or -tai- eller 88	118+2 154+2	114x19 88x19	2750
FF1	SKIRTING SLAT - LATTIALISTA - GOLVLIST			19x35	47 m
GB1	GABLE BOARD - KAAPELILAUTA - GAVELBRÄDA		4	19x120	2800
GS1	BOARD MATCHING WITH GABLE BOARD-KAAPELILAUTA VASTAVA LAUTA-BRÄDA OVANPÅ GAVELBRÄDA		4	19x70	2800
EB1	EAVE BOARD - RÄYSTÄSLAUTA - TAKFOTBRÄDE		4	19x90	3340
ES1	EAVE SLAT - RÄYSTÄSLISTA - TAKFOTLIST		4	30x40	3340
DB1	DECORATIVE - KORISTE - PRYDNADS		2	19x90	200
CDB1	CORNER DECORATION BOARD- HÖRN DEKORATION BRÄDE		22	120x19	2790
CDB2	CORNER DECORATION BOARD- HÖRN DEKORATION BRÄDE		3	90x19	2790
CDB3	CORNER DECORATION BOARD- HÖRN DEKORATION BRÄDE		16	70x19	2790
WF1	SIDEWALL SKIRTING SLAT-KATTOLISTA-PÄÄDYT -TAKLIST-GAVLAR		2	19x90	3270
WF2	SIDEWALL SKIRTING SLAT-KATTOLISTA-PÄÄDYT -TAKLIST-GAVLAR		2	19x90	2292
WF3	SIDEWALL SKIRTING SLAT-KATTOLISTA-PÄÄDYT -TAKLIST-GAVLAR		4	19x90	448
DT1	DOOR ASSEMBLING PROFILE-OVEN ASENNUSPROFIILI -DÖRR MONTERINGSPROFIL		4	43x70	2060
DT2	DOOR ASSEMBLING PROFILE-OVEN ASENNUSPROFIILI -DÖRR MONTERINGSPROFIL		4	43x70	1990
House	P5843-70 Diana	Material	File	P5843-70 Diana.dwg	Sheet 17

Pos	P5843-70 Diana		Pcs. St.	Profil(e) (mm)	L (mm)	
WT1	WINDOW ASSEMBLING PROFILE-IKKUNA ASENNUSPROFILI -FÖNSTER MONTERINGSPROFIL		8	43x70	640	
FLT1	ASSEMBLING PROFILE-ASENNUSPROFILI-MONTERINGSPROFIL		2	25x19	780	
SJ1	SCREW JOINT-KIERRETANKO-GÄNGSTAPP		6	ØM10	2770	
RCM	ROOFBEAMS CONNECTING METAL-METALL FÖR SAMMANFOGNING AV TAKASAR-KATTO-ORRE YHTEENLITYSMETALLT		5	Ø6	200	
WCM	WALLBEAMS CONNECTING METAL-METALLPLATTA FÖR SAMMANFOGNING AV VÄGGEN BALKAR-SEINÄPALKKEJA METALLISET YHTEENLIITYMISLAATAT		4	50	50	
	NAILS-NAULAT-SPIKAR FOR-VARTEN-FÖR	FF1		110	Ø2.0	40
	NAILS-NAULAT-SPIKAR FOR-VARTEN-FÖR	F1, F2, L1, R1, BB1, BB2		1600	Ø2.5	60
	SCREWS-RUUVIT-SKRUVAR FOR-VARTEN-FÖR	WCM, CDB3		100	Ø3.5	35
	SCREWS-RUUVIT-SKRUVAR FOR-VARTEN-FÖR	GB1, GS1, EB1, ES1, DB1, CB CDB1, CDB2, WF1, WF2, WF3		300	Ø4.5	50
	SCREWS-RUUVIT-SKRUVAR FOR-VARTEN-FÖR	FS1, FS2, LB1, SB		50	Ø4.5	70
	SCREWS-RUUVIT-SKRUVAR FOR-VARTEN-FÖR	015, 017, 019, 022, 041 FB1, FB2, FB3, FB4, FB5, FB6		80	Ø4.5	90
	SCREWS-RUUVIT-SKRUVAR FOR-VARTEN-FÖR	FB2, FB4, FB6		60	Ø5.0	120
	SCREWS-RUUVIT-SKRUVAR FOR-VARTEN-FÖR	RB1, RB2, RB3, RB4, RB5, RB6		20	Ø6.0	160
LD1	LADDER-TIKAPUUT-STEGE		1	700	2760	
D1	DOOR-OVI-DÖRR (right-oikea-höger) ORT_ST 990 	P	1	990	2090	
			1			
			1			
			1			

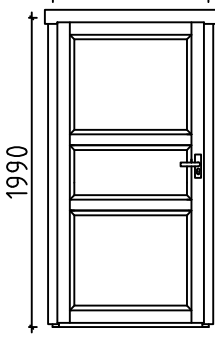
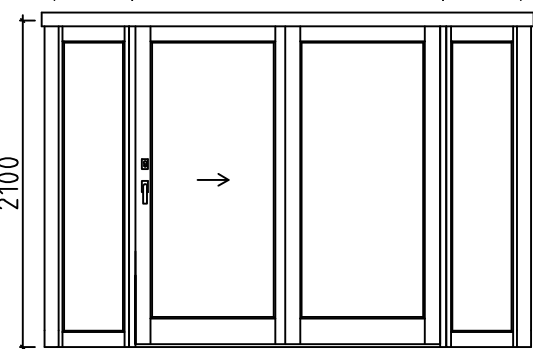
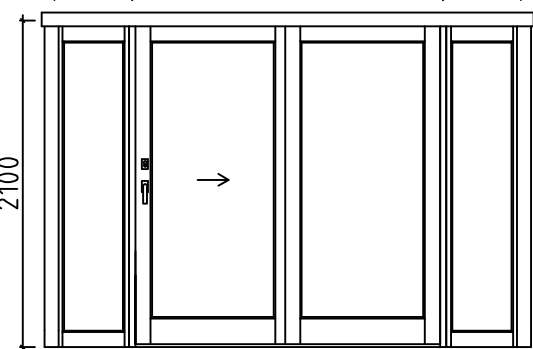
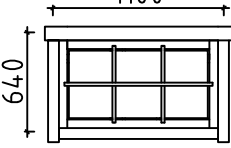
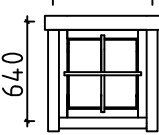
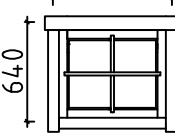
Pos	P5843-70 Diana	Pcs. St.	Profil(e) (mm)	L (mm)
D2	DOOR-OVI-DÖRR (left-jäljellä-vänster) AST 1000 	V 2 2 2	1000	1990
D3	DOOR-OVI-DÖRR (left-jäljellä-vänster) ORT_LYK 500 2000 500 	V 1	2000	2100
W1	WINDOW-IKKUNAN-FÖNSTER ORT_ST_K 500 2000 500 	2 1 1 1	500	2100
W2	WINDOW-IKKUNAN-FÖNSTER ORT_ST_SU 1100 	2 2 2 2	1100	640
W3	WINDOW-IKKUNAN-FÖNSTER (right-oikea-höger) ORT_ST 640 	P 1 1 1	640	640
W4	WINDOW-IKKUNAN-FÖNSTER ORT_ST_SU 765 	1 1 1	765	640
House	P5843-70 Diana	Material	File	P5843-70 Diana.dwg
			Sheet	19

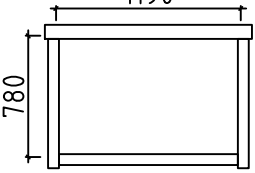
Pos	P5843-70 Diana	Pcs. St.	Profil(e) (mm)	L (mm)
FL1	FRAME AROUND LOFT ENTRANCE 1190 	1	1190	780

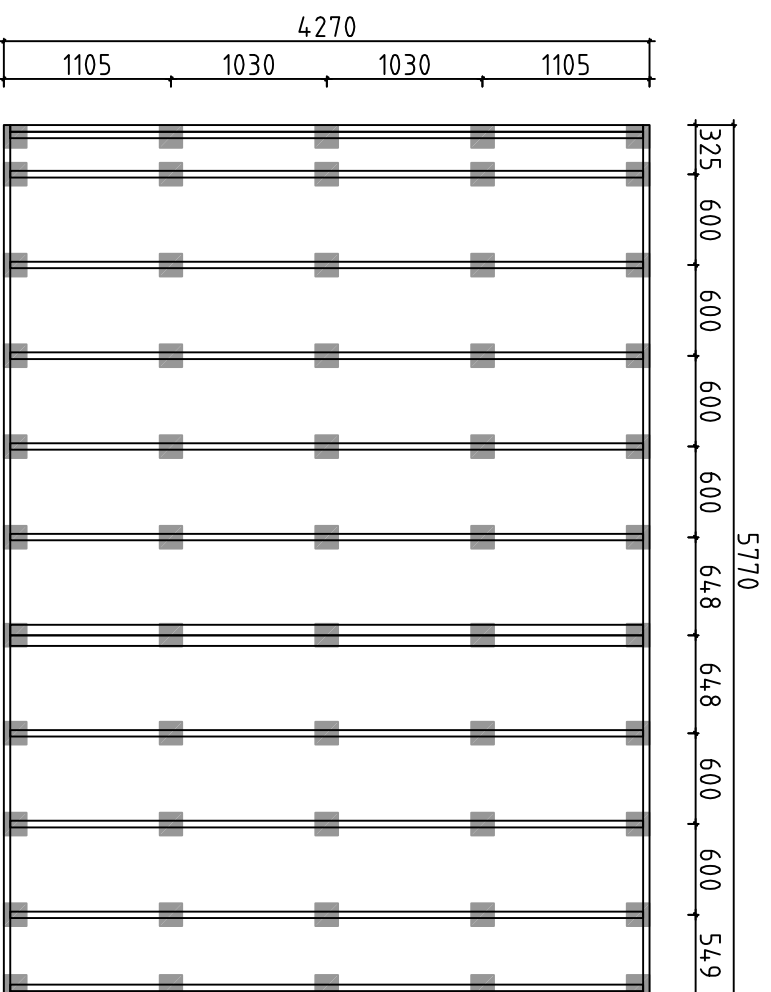

Detta är ett förslag för hur man kan placera plintarna (100-200 mm i diameter) för golvbjälklaget. Golvbjälkarna är med i byggsatsen, men inte plintarna. Använder man exempelvis 500-600mm långa murblock så kan man halvera antalet punkter. Lägg fuktskyddande papp mellan betong och trä

Tämä on ehdotus siitä, miten (100-200 mm läpimittaiset) jalat voidaan sijoittaa alapohjaa varten. Lattiapalkit ovat rakennussarjassa, mutta jalkoja ei ole. Kun käytetään esimerkiksi 500-600 mm pitkiä harkkoja, voidaan pisteiden määrä puoltaa. Aseta betonin ja puun väliin kosteudelta suojava pahvi

A proposal for placing plinths (100-200 mm in diameter) for floor beams. Floor beams are provided in the kit but plinths are not included. For example, by using 500-600 mm long masonry units, one can reduce the number of points 50%. Place cardboard between the concrete and wood to protect from moisture

House	P5843-70 Diana	Sheet	21
Drawing	FOUNDATION PLAN - PLINTPLAN	Scale	1:50
Material		Date	05.01.2017
Drawer	RP	File	P5843-70 Diana Foundation.dwg

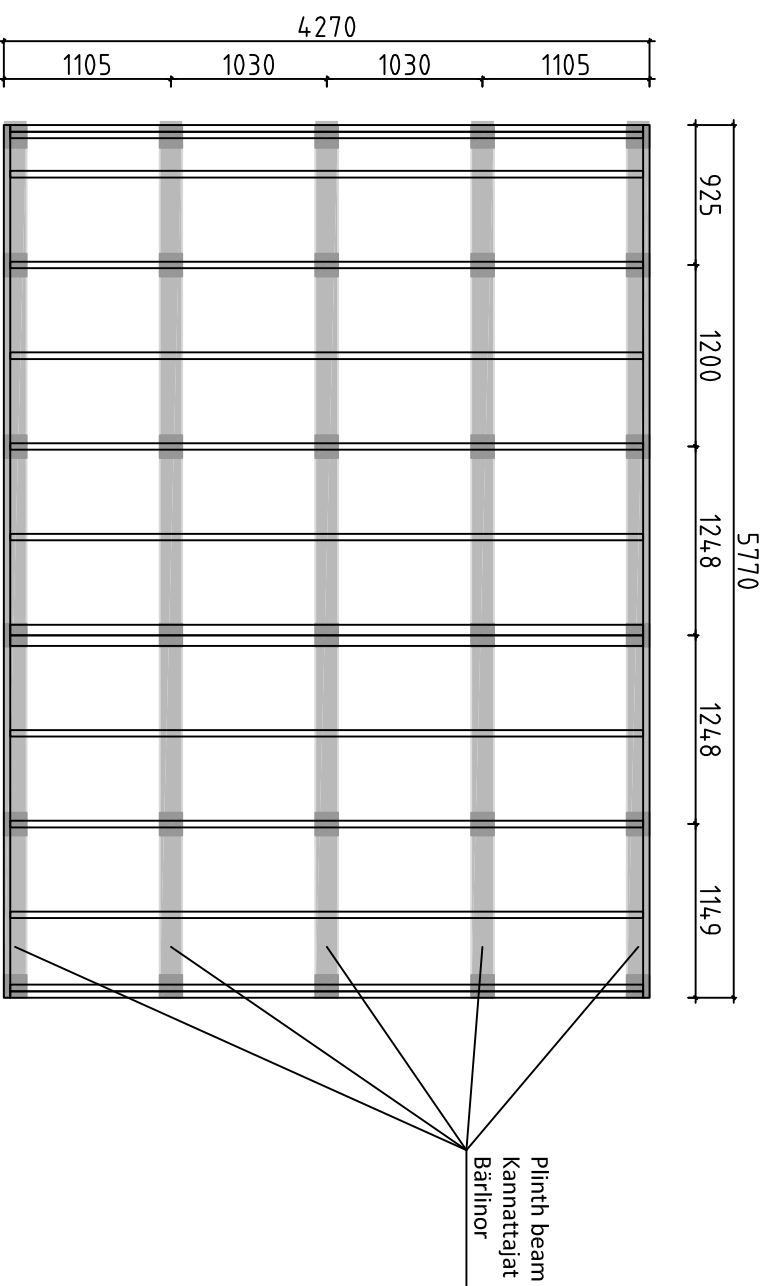

Förslag på alternativ plintplan med bärlnor och plintar. Bärlnor 45x95 eller 45x120 och plintar ca 100-200 mm i diameter. (Bärlnor och plintar ingår ej i leveransen). Används exempelvis murblock, (ingår ej i leveransen) istället för plintar, kan man lägga bärlnorra platt mot dessa och på det sättet minska höjden på konstruktionen. I denna konstruktion kan man dessutom lägga en "boardskiva" mellan bärlnorra och golvbjälkarna och på det sättet bära upp bjälklagsisoleringen. Läggs fuktskyddande papp mellan betong och trä

Endotus valtoehtoisestä jalustasta kannattajilla ja jalloilla. Kannattajat 45x95 tai 45x120 ja jalat läpimitataan n. 100-200 mm (kannattajat ja jalat ei ole toimituksessa). Käytettäessä esimerkiksi harkkoja (ei kuulu toimitukseen) jalkojen sijasta, voi kannattajat asettaa lappeelleen niitä vasten ja sillä tavoin vähentää rakenteen korkeutta. Tässä rakenteessa voi lisäksi asettaa levyä kannattajien ja lattiapalkkien väliin ja sillä tavoin kannattaa alapohjan eristystä. Aseta betonin ja puun väliin kosteudelta suojaava pähvi

A proposal for alternative plinth beam layout plan. Plinth beams 45x95 or 45x120 and plinths ca 100-200 mm in diameter (plinth beams and plinths are not included in the kit). For example, by using masonry units (not included in the kit) instead of plinths, one can lay plinth beams flat against the masonry units and in that way reduce the height of the structure. In this construction one can also add "plywood board" between plinth beams. Place cardboard between the concrete and wood to protect from moisture

House	P5843-70 Diana	Sheet	22
Drawing	FOUNDATION PLAN - PLINTPLAN	Scale	1:50
Material		Date	05.01.2017
Drawer	RP	File	P5843-70 Diana Foundation.dwg

#001	3	5980	1
#002	1,3	5980	4
#003	1	5980	1
#004		5980	1
#005	A	4480	1
#006	A,C	4480	21
#007	B,C	4480	18
#008	B	4480	1
#009	A	3937	1
#010	1,3	3829	2
#011	1,3	3829	2
#012	1,3	2851	2
#013	1,3	2851	2
#014	A	2795	1
#015	1,3	2636	2
#016	1,3	2636	20
#017	2	2636	1
#018	2	2636	16
#019	2	2636	1
#020	A,B,C	2565	3
#021	1	2304	10
#022	1	2304	1
#023	C	1833	2
#024	C	1833	4
#025	B	1640	2
#026	B	1640	6
#027	C	1562	2
#028	A,B,C	1424	3
#029	B	1369	2
#030	B	1367	15
#031	A,B,C	1194	3
#032	C	991	2
#033	1	973	5
#034	1	973	5
#035	B	798	2
#036	3	743	5
#037	1,3	743	10
#038	B	743	15
#039	1	411	5
#040	3	290	15
#041	3	290	1
#042	B	270	15
#043	A,B,C	224	6
#044	A,B,C	168	12