

Date rev. Description

House	P5843-44 Eva	Sheet	1
-------	--------------	-------	---

Drawing	3D	Scale	
---------	----	-------	--

Material	44x135	Date	22.11.2017
----------	--------	------	------------

Drawer	RP	File	P5843-44_Eva 3D.dwg
--------	----	------	---------------------

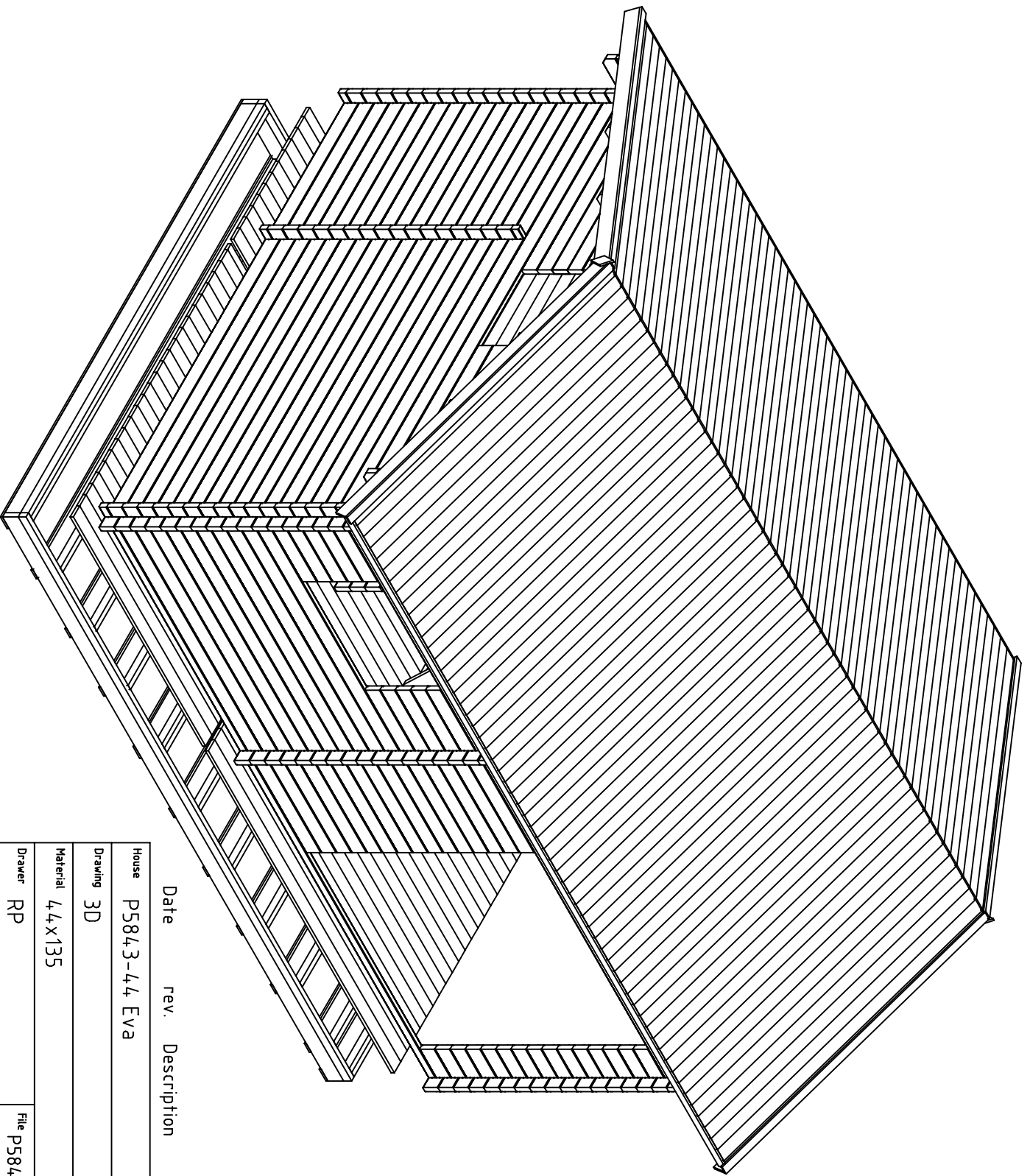

Date rev. Description

House	P5843-44 Eva	Sheet	2
-------	--------------	-------	---

Drawing	3D	Scale	
---------	----	-------	--

Material	4,4x135	Date	22.11.2017
----------	---------	------	------------

Drawer	RP	File	P5843-44 Eva 3D.dwg
--------	----	------	---------------------

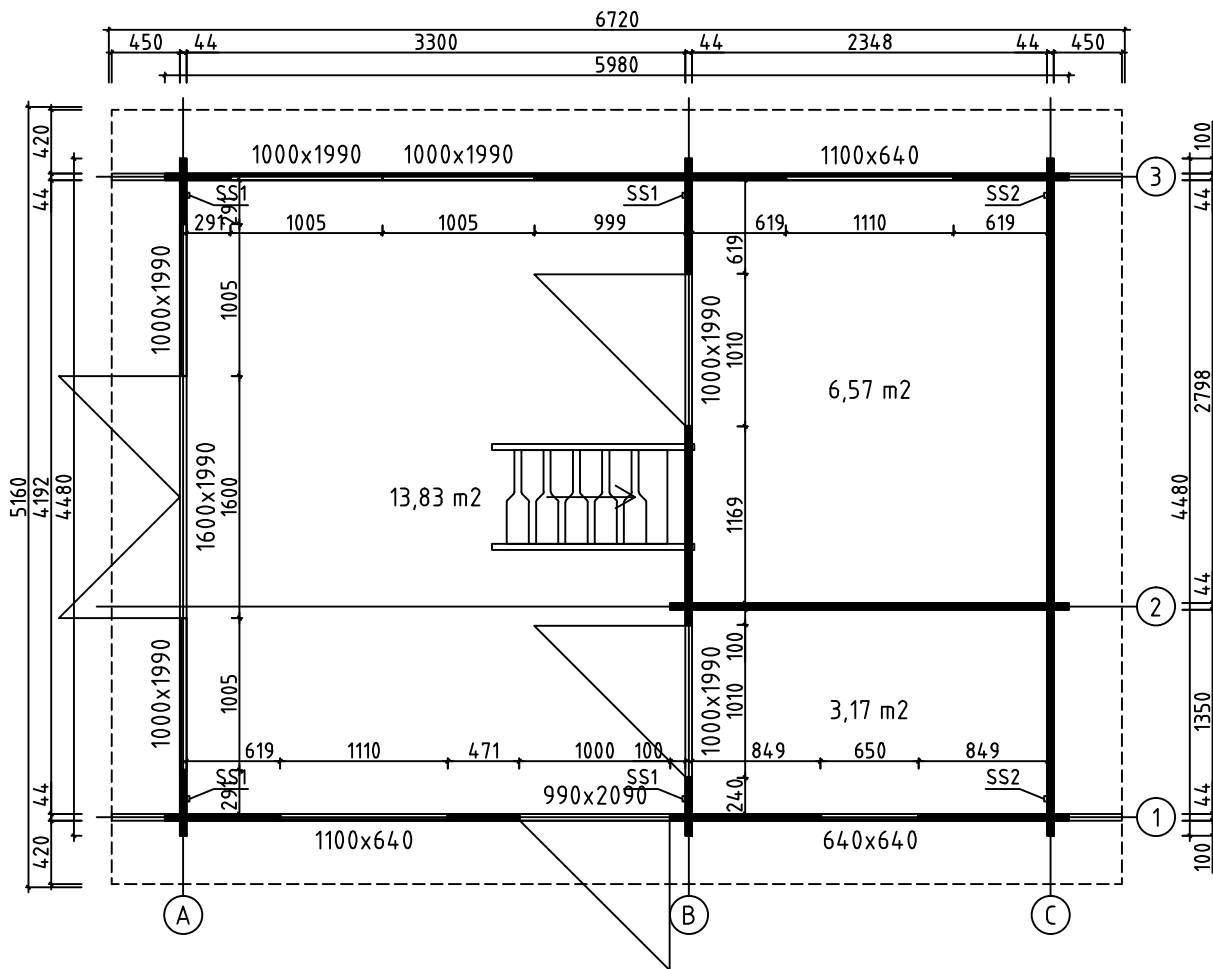

House	P5843-44 Eva	Sheet	3
Drawing	PLAN-SUUNNITELMA-PLANEN	Scale	1:50
Material	44x135	Date	22.11.2017
Drawer	RP	File	P5843-44 Eva.dwg

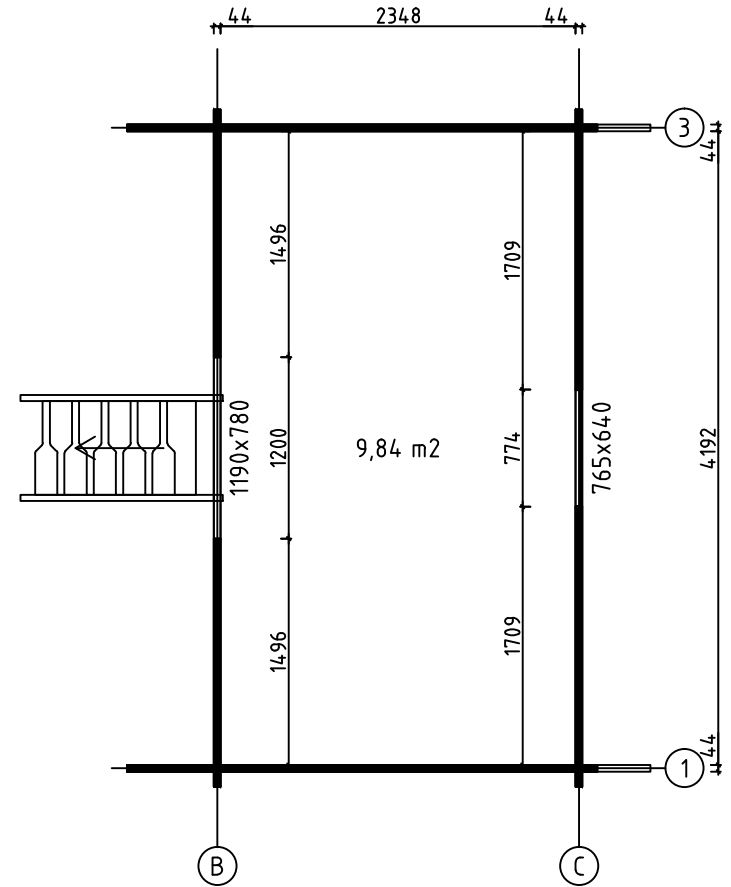
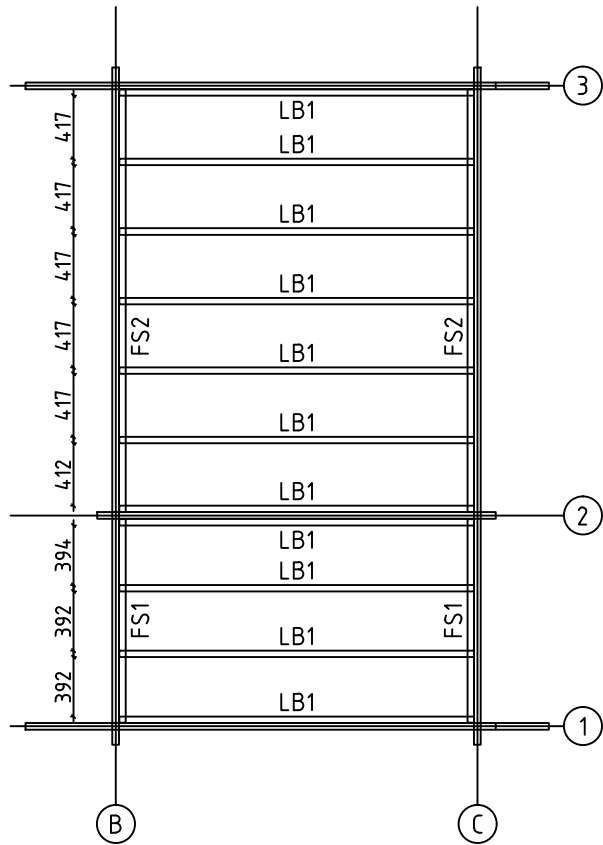

LOFT FLOOR BEAMS - PARVIA LATTIAPALKIT - LOFT GOLVBJÄLKAR

House	P5843-44 Eva	Sheet	4
Drawing	LOFT FLOOR - PARVIA LATTIA - LOFT GOLV	Scale	1:50
Material	43x43, 43x140 44x135	Date	22.11.2017
Drawer	RP	File	P5843-44 Eva.dwg

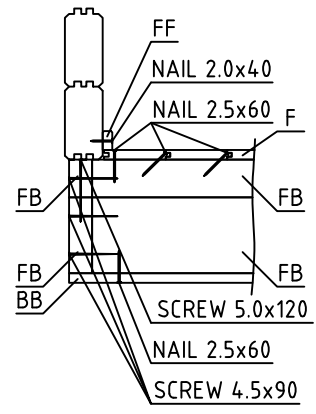
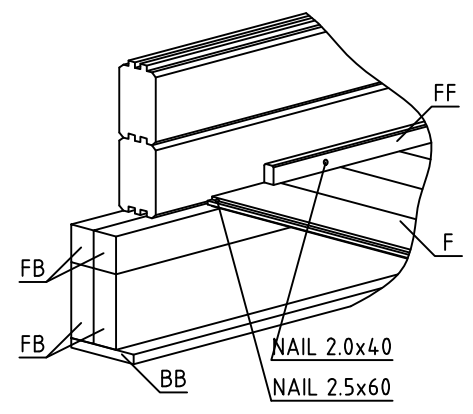
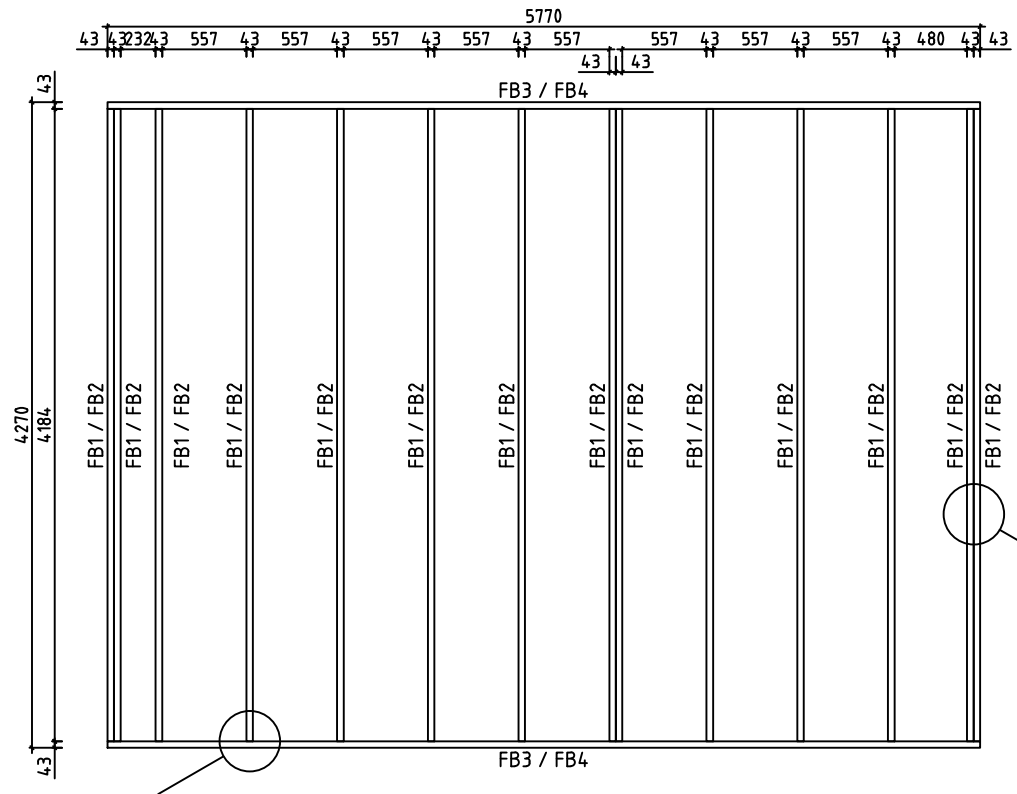

House	P5843-44 Eva	Sheet	5
Drawing	FLOORBEAMS-LATTIAPALKIT-GOLVBJÄLKAR	Scale	1:50
Material	43x140, 43x70	Date	22.11.2017
Drawer	RP	File	P5843-44 Eva.dwg

F1

F2



F2

FLOORBOARD-LATTIALAUTA-GOLVBRÄDE

L1

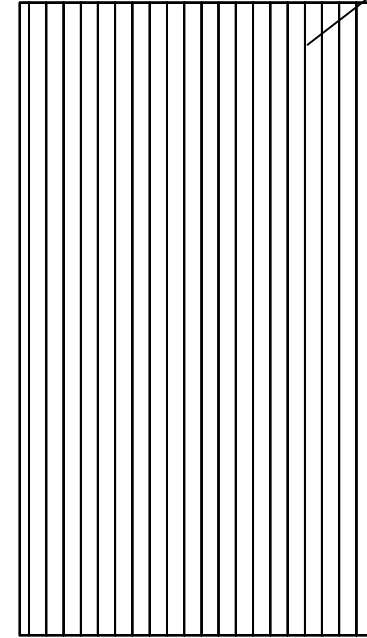

LOFT FLOORBOARD - PARVIA LATTIALATTIA - LOFT GOLVBRÄDE

House	P5843-44 Eva	Sheet	6
Drawing	FLOORBOARD-LATTIALAUTA-GOLVBRÄDE	Scale	1:50
Material	28x114, 18x114	Date	22.11.2017
Drawer	RP	File	P5843-44 Eva.dwg

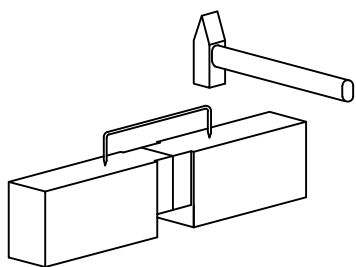
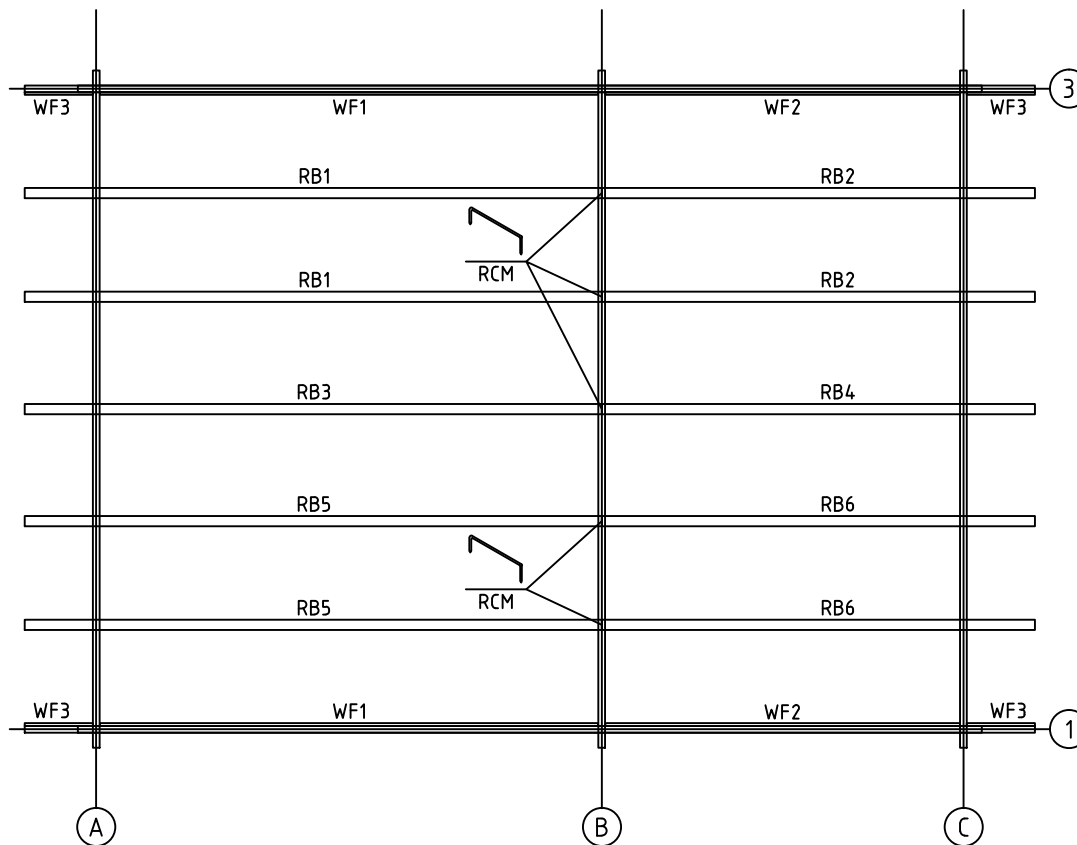

House	P5843-44 Eva	Sheet	7
Drawing	PURLINS-KATTO-ORRET-TAKÅSAR	Scale	1:50
Material	68x190, 18x70	Date	22.11.2017
Drawer	RP	File	P5843-44 Eva.dwg







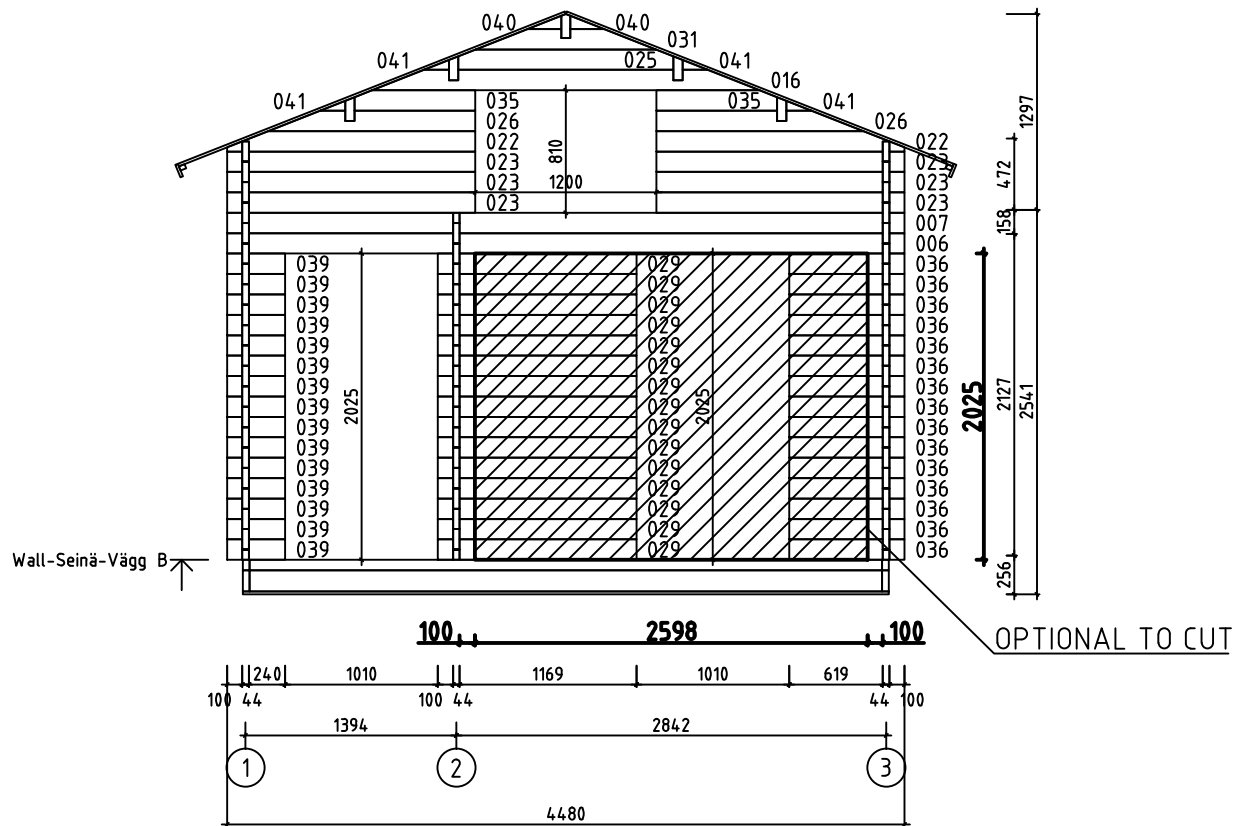

House	P5843-44 Eva	Sheet	9A
Drawing	WALL-SEINÄ-VÄGG B	Scale	1:50
Material	44x135	Date	22.11.2017
Drawer	RP	File	P5843-44 Eva Optional.dwg





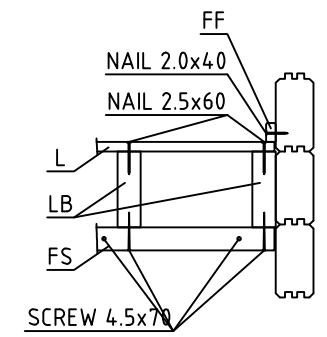
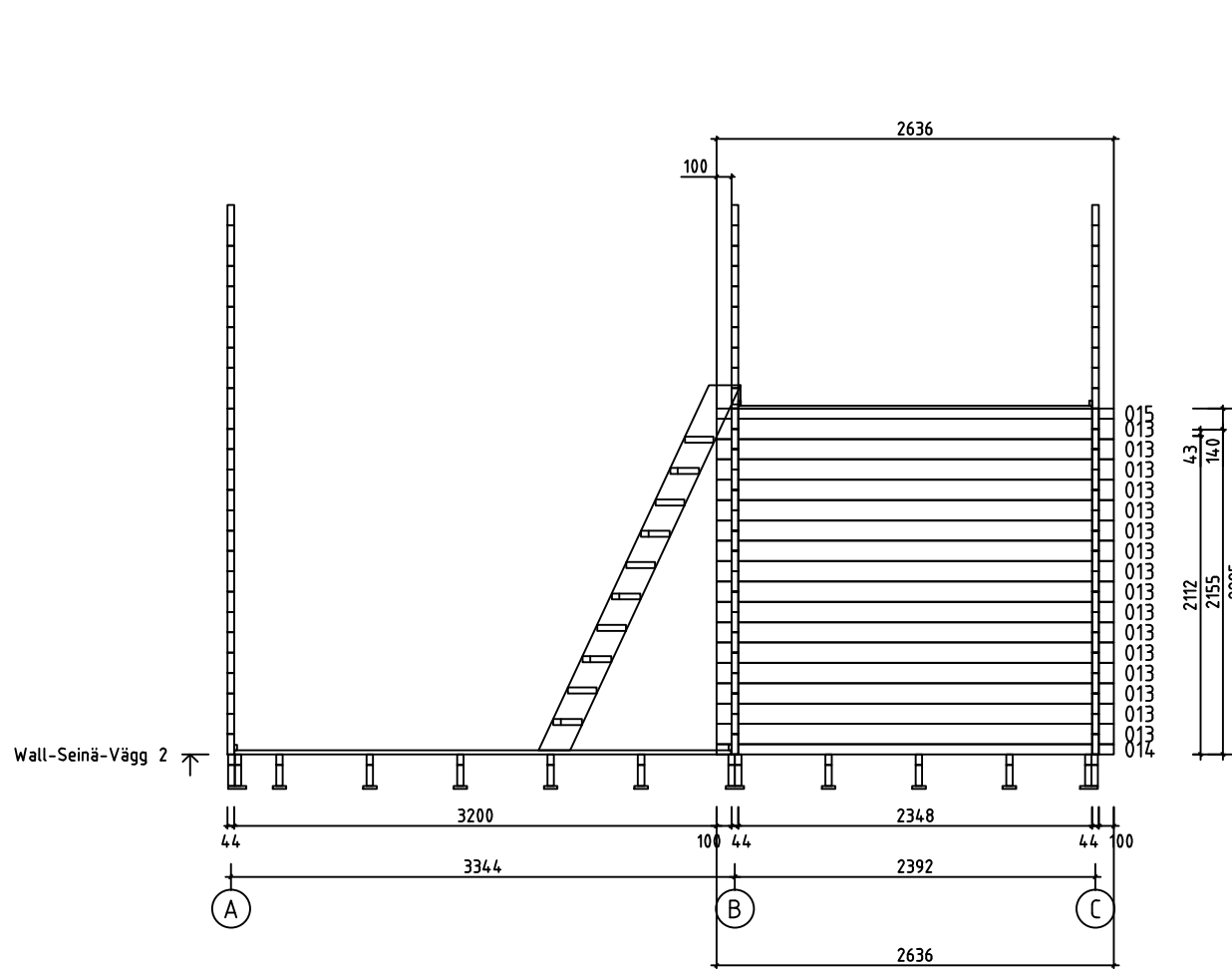





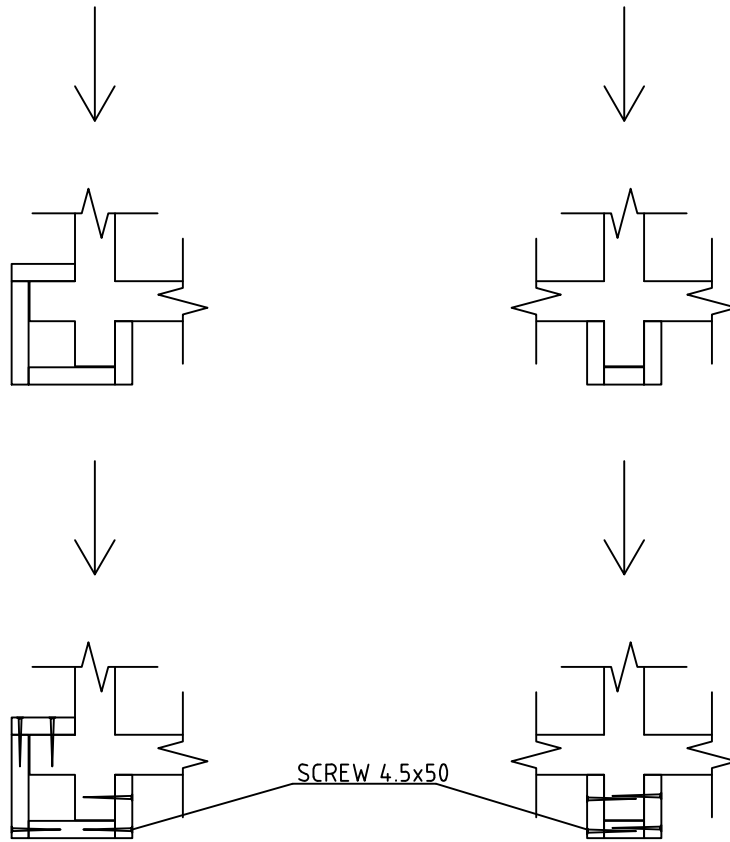
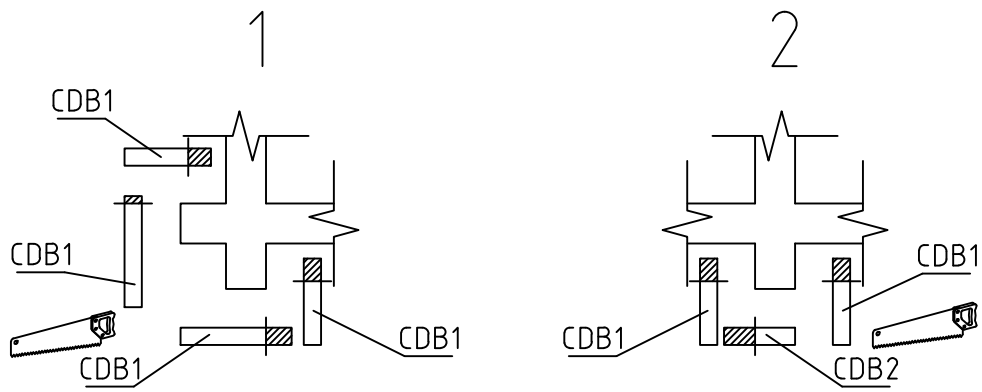
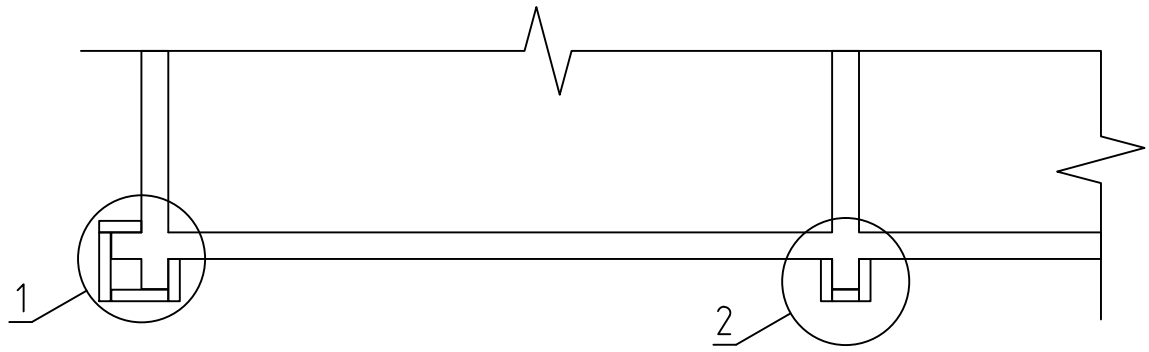



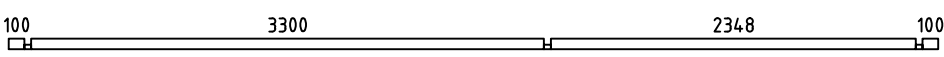
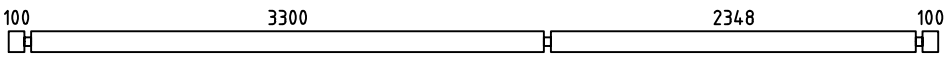
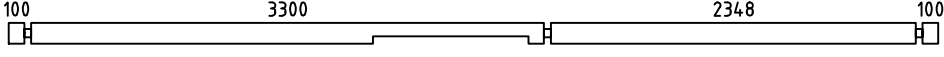
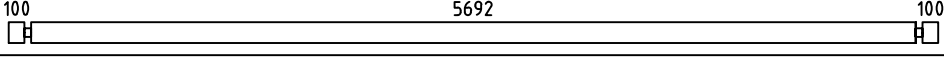
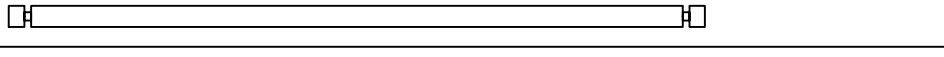
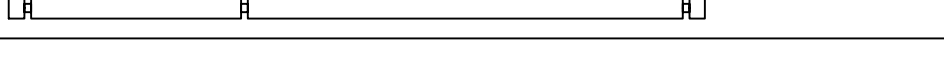
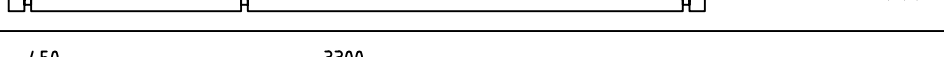
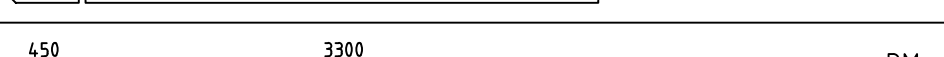
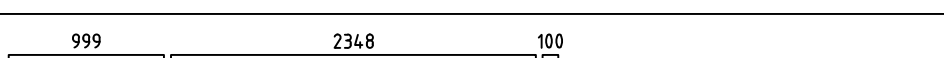
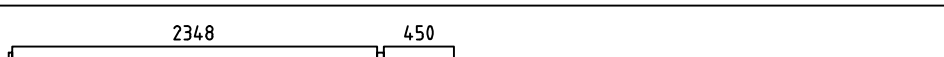

House	P5843-44 Eva	Sheet	12
Drawing	WALL-SEINÄ-VÄGG 2	Scale	1:50
Material	44x135	Date	22.11.2017
Drawer	RP	File	P5843-44 Eva.dwg



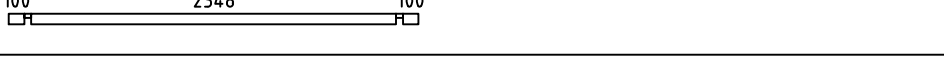
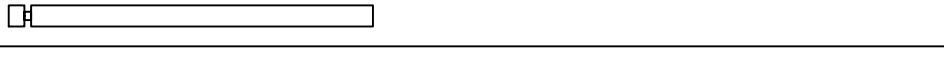
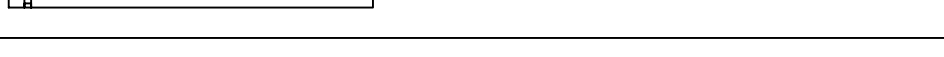
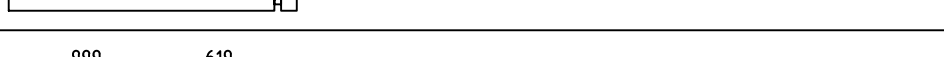
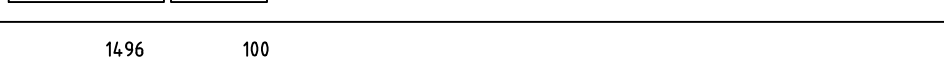
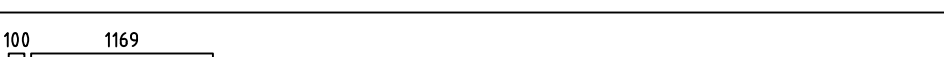
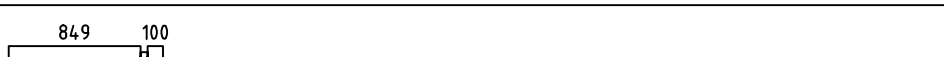



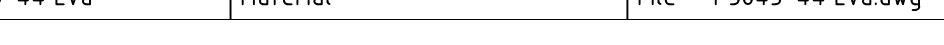





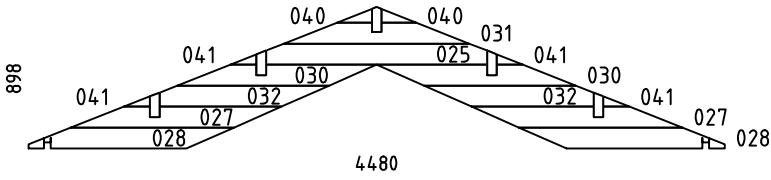
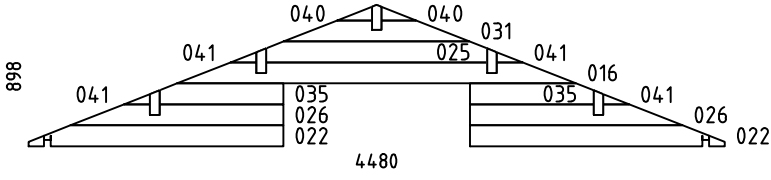
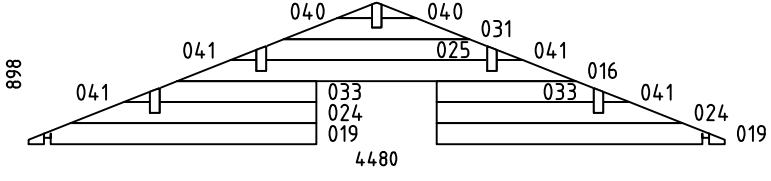

SCREW 4.5x50













House	P5843-44 Eva	Sheet	14
Drawing	CORNER DECORATION - HÖRN DEKORATION	Scale	1:50
Material		Date	22.11.2017
Drawer	RP	File	P5843-44 Eva.dwg

Pos	P5843-44 Eva	Pcs. St.	Profil(e) (mm)	L (mm)
001		1	44x68	5980
002		5	44x135	5980
003		1	44x135	5980
004	SPARE BEAM - VARALLAPALKI - RESERVDEL 	1	44x135	5980
005		6	44x135	4480
006		18	44x135	4480
007		PM 1	44x135	4480
008		2	44x135	3816
009		PM 2	44x135	3816
010		10	44x135	3535
011		2	44x135	2864
012		PM 2	44x135	2864
013		26	44x135	2636
014		2	44x68	2636
015		1	44x68	2636
017		10	44x135	2344
018		1	44x68	2344
020		4	44x135	1853
021		5	44x135	1662
023		6	44x135	1640
029		15	44x135	1313
034		10	44x135	993
036		25	44x135	763
037		5	44x135	471
038		45	44x135	435

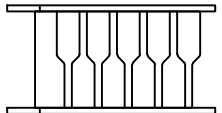
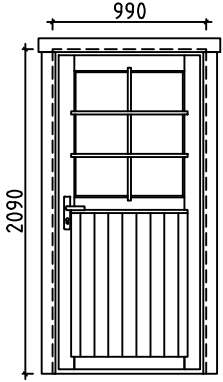

Pos	P5843-44 Eva		Pcs. St.	Profil(e) (mm)	L (mm)
039			15	44x135	384
WA-1			1	44x898	4480
WB-1			1	44x898	4480
WC-1			1	44x898	4480
HB	HIT BLOCK-ASENNUSPALKI-SLAG BRÄDA		2	44x135	300
LB1	LOFT FLOOR BEAMS-PARVIAPALKIT-LOFTBJÄLKAR		11	43x140	2345
FB3	FLOORBEAMS - LATTIAPALKIT - GOLVBJÄLKAR		2	43x140	5770
FB2	FLOORBEAMS - LATTIAPALKIT - GOLVBJÄLKAR		14	43x140	4184
FB4	FLOORBEAMS - LATTIAPALKIT - GOLVBJÄLKAR		2	43x70	5770
FB1	FLOORBEAMS - LATTIAPALKIT - GOLVBJÄLKAR		14	43x70	4184
BB1	COUNTERFLOOR HOLDING BOARDS - ROSSIPOHJAA KANNATTELEVAT LAUDAT - BRÄDER SOM HALLER TROSSBOTTEN		3	18x120	4270
BB2	COUNTERFLOOR HOLDING BOARDS - ROSSIPOHJAA KANNATTELEVAT LAUDAT - BRÄDER SOM HALLER TROSSBOTTEN		8	18x90	4270
FS2	SLEEPING FLOOR SUPPORTING SLAT - PARVIALATTIA TUKILISTA - LOFTGOLVLIST		2	43x43	2795
FS1	SLEEPING FLOOR SUPPORTING SLAT - PARVIALATTIA TUKILISTA - LOFTGOLVLIST		2	43x43	1345
RB5	 450	PURLINS - KATTO-ORRET - TAKASAR 3300	2	68x190	3816
RB1	 450	PURLINS - KATTO-ORRET - TAKASAR 3300	2	68x190	3816
RB3	 450	PURLINS - KATTO-ORRET - TAKASAR 3300	1	68x190	3816
RB6	 2348	PURLINS - KATTO-ORRET - TAKASAR 450	2	68x190	2864
RB2	 2348	PURLINS - KATTO-ORRET - TAKASAR 450	2	68x190	2864
House	P5843-44 Eva	Material	File	P5843-44 Eva.dwg	Sheet 16

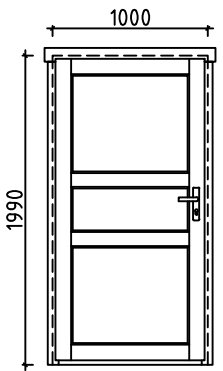
Pos	P5843-44 Eva			Pcs. St.	Profil(e) (mm)	L (mm)
RB4	<p>PURLINS - KATTO-ORRET - TAKASAR</p>			1	68x190	2864
F1	FLOORBOARD - LATTIALAUTA - GOLVBRÄDE		114 or-tai-eller 88	37+1 48+1	28x114 28x88	3295
F2	FLOORBOARD - LATTIALAUTA - GOLVBRÄDE		114 or-tai-eller 88	37+1 48+1	28x114 28x88	2345
L1	LOFT BOARD - PARVIALATTIA - LOFTGOLV		114 or-tai-eller 88	21+1 28+1	18x114 18x88	4185
R1	ROOFBOARD - KATTOLAUTA - TAKBRÄDE		114 or-tai-eller 88	118+2 154+2	18x114 18x88	2750
FF1	SKIRTING SLAT - LATTIALISTA - GOLVLIST				18x35	46m
GB1	GABLE BOARD - KAAPELILAUTA - GAVELBRÄDA			4	18x120	2800
GS1	BOARD MATCHING WITH GABLE BOARD - KAAPELILAUTA VASTAVA LAUTA - BRÄDA OVANPÅ GAVELBRÄDA			4	18x70	2800
EB1	EAVE BOARD - RÄYSTÄSLAUTA - TAKFOTBRÄDE			4	18x90	3340
ES1	EAVE SLAT - RÄYSTÄSLISTA - TAKFOTLIST			4	30x40	3340
DB1	DECORATIVE - KORISTE - PRYDNADS			2	18x90	200
CDB1	CORNER DECORATION BOARD - HÖRN DEKORATION BRÄDE			22	18x120	2790
CDB2	CORNER DECORATION BOARD - HÖRN DEKORATION BRÄDE			3	18x90	2790
WF1	SIDEWALL SKIRTING SLAT-KATTOLISTA-PÄÄDYT - TAKLIST-GAVLAR			2	18x70	3295
WF2	SIDEWALL SKIRTING SLAT-KATTOLISTA-PÄÄDYT - TAKLIST-GAVLAR			2	18x70	2345
WF3	SIDEWALL SKIRTING SLAT-KATTOLISTA-PÄÄDYT - TAKLIST-GAVLAR			2	18x70	450
CB1	COVERING BOARD - PEITELAUTA - HYLLBRÄDA			1	18x120	3900
SB1	SUPPORT BOARD - TUKILAUTA - KONSOL			2	28x85	80
SS1	STORM SLAT - MYRSKY LISTA - OVÄDER SPJÄLA			4	18x35	2700
SS2	STORM SLAT - MYRSKY LISTA - OVÄDER SPJÄLA			2	18x35	2020
RCM	ROOFBEAMS CONNECTING METAL - METALL FÖR SAMMANFOGNING AV TAKASAR - KATTO-ORRE YHTEENLITYSMETALLT			5	ø6.0	200
WCM	WALLBEAMS CONNECTING METAL - METALLPLATTA FÖR SAMMANFOGNING AV VÄGGEN BALKAR - SEINÄPALKKEJA METALLISET YHTEENLIITYMISLAATAT			4	25	25
	SCREWS-RUUVIT-SKRUVAR FOR-VARTEN-FÖR SS1, SS2			18	ø6.0	50
	WASHER-ALUSLAATTA-BRICKA FOR-VARTEN-FÖR SS1, SS2			18	ø6.0	18
	NAILS-NAULAT-SPIKAR FOR-VARTEN-FÖR FF1			110	ø2.0	40
	NAILS-NAULAT-SPIKAR FOR-VARTEN-FÖR F1, F2, L1, R1, BB1, BB2			1600	ø2.5	60
House	P5843-44 Eva	Material	File	P5843-44 Eva.dwg	Sheet	17

Pos	P5843-44 Eva		Pcs. St.	Profil(e) (mm)	L (mm)	
	SCREWS-RUUVIT-SKRUVAR FOR-VARTEN-FÖR	WCM		20	Ø3.5	35
	SCREWS-RUUVIT-SKRUVAR FOR-VARTEN-FÖR	CDB1, CDB2, WF1, WF2, WF3 GB1, GS1, EB1, ES1, DB1, CB		300	Ø4.5	50
	SCREWS-RUUVIT-SKRUVAR FOR-VARTEN-FÖR	FS1, FS2, LB1, SB		50	Ø4.5	70
	SCREWS-RUUVIT-SKRUVAR FOR-VARTEN-FÖR	001, 014, 015, 018 FB1, FB2, FB3, FB4		70	Ø4.5	90
	SCREWS-RUUVIT-SKRUVAR FOR-VARTEN-FÖR	FB2, FB4		60	Ø5.0	120
	SCREWS-RUUVIT-SKRUVAR FOR-VARTEN-FÖR	RB1, RB2, RB3, RB4, RB5, RB6		20	Ø6.0	160
LD1	LADDER-TIKAPUUT-STEGE		1	700	2760	
D1	DOOR-OVI-DÖRR (right-oikea-höger) ORT_ST 	  	P 1 1 1	990	2090	
D2	DOOR-OVI-DÖRR (left-jäljellä-vänster) AST 	 	V 2 2	1000	1990	
House P5843-44 Eva		Material	File P5843-44 Eva.dwg	Sheet 18		

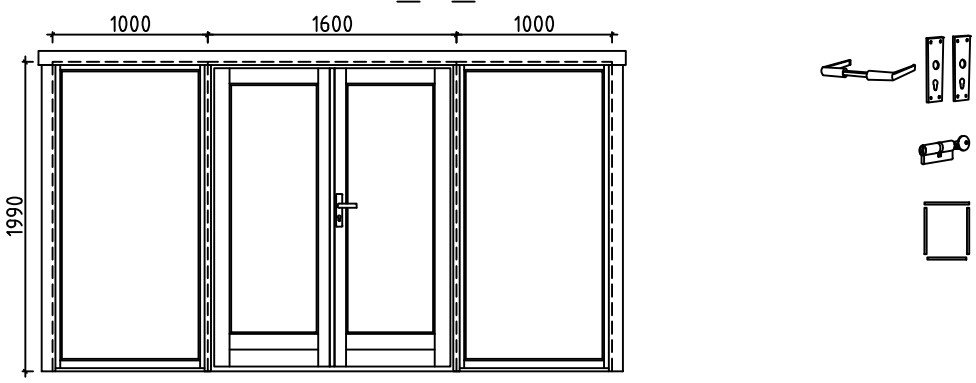
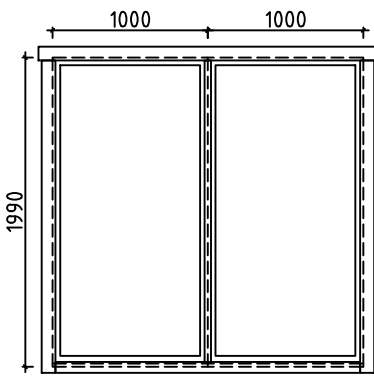
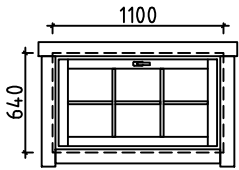
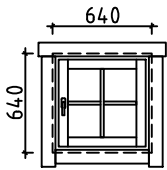
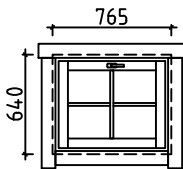
Pos	P5843-44 Eva	Pcs. St.	Profil(e) (mm)	L (mm)
D3	DOOR-OVI-DÖRR (right-oikea-höger) ORT_ST	P 1	1600	1990
W1	WINDOW-IKKUNAN-FÖNSTER ORT_ST_K 	2 1 1 1	1000	1990
W2	WINDOW-IKKUNAN-FÖNSTER ORT_ST_K 	2	1000	1990
W3	WINDOW-IKKUNAN-FÖNSTER ORT_ST_SU 	P 2 2 2 2	1100	640
W4	WINDOW-IKKUNAN-FÖNSTER (right-oikea-höger) ORT_ST 	P 1 1 1 1	640	640
W5	WINDOW-IKKUNAN-FÖNSTER ORT_ST_SU 	1 1 1 1	765	640
House	P5843-44 Eva	Material	File	P5843-44 Eva.dwg
			Sheet	19

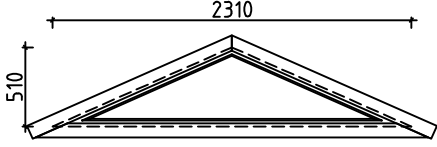
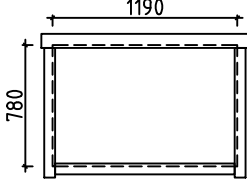
Pos	P5843-44 Eva	Pcs. St.	Profil(e) (mm)	L (mm)
W6	WINDOW-IKKUNAN-FÖNSTER ORT_ST_K 	1	2310	510
FL1	FRAME AROUND LOFT ENTRANCE 	1	1190	780

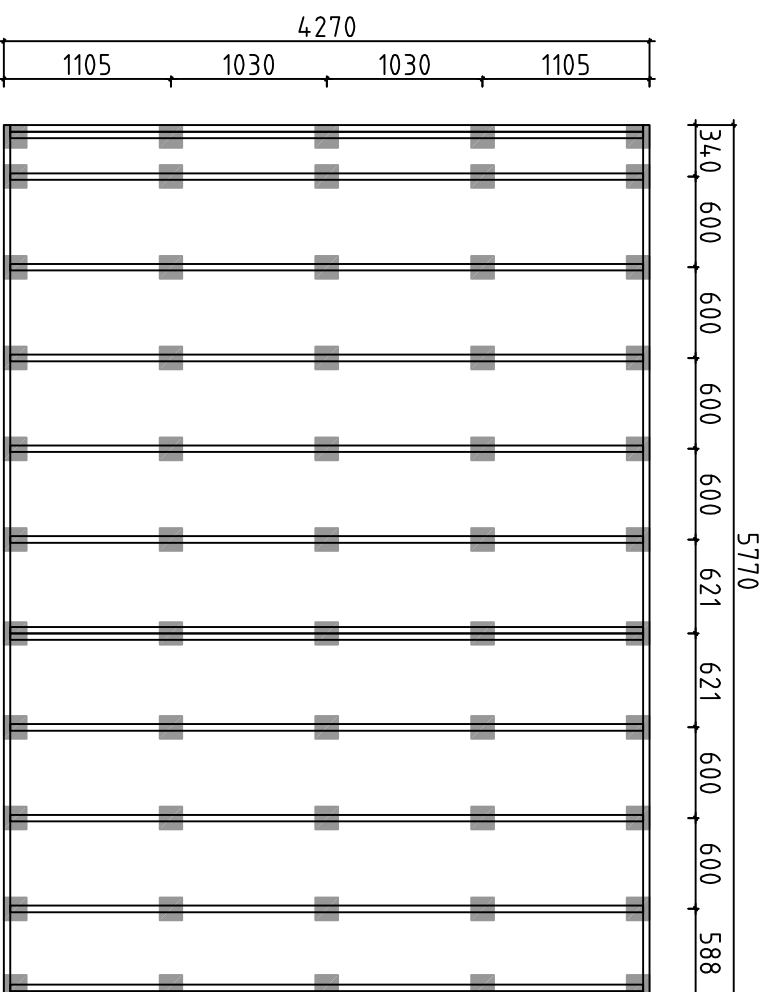

Detta är ett förslag för hur man kan placera plintarna (100-200 mm i diameter) för golvbjälklaget. Golvbjälkarna är med i byggsatsen, men inte plintarna. Använder man exempelvis 500-600mm långa murblock så kan man halvera antalet punkter. Lägg fuktskyddande papp mellan betong och trä

Tämä on ehdotus siitä, miten (100-200 mm läpimittaiset) jalat voidaan sijoittaa alapohjaa varten. Lattiapalkit ovat rakennussarjassa, mutta jalkoja ei ole. Kun käytetään esimerkiksi 500-600 mm pitkiä harkkoja, voidaan pisteiden määrä puoltaa. Aseta betonin ja puun väliin kosteudelta suojava pahvi

A proposal for placing plinths (100-200 mm in diameter) for floor beams. Floor beams are provided in the kit but plinths are not included. For example, by using 500-600 mm long masonry units, one can reduce the number of points 50%. Place cardboard between the concrete and wood to protect from moisture

House	P5843-44 Eva	Sheet	21
Drawing	PLINTPLAN - FOUNDATION PLAN	Scale	1:50
Material		Date	22.11.2017
Drawer	RP	File	P5843-44 Eva Foundation.dwg

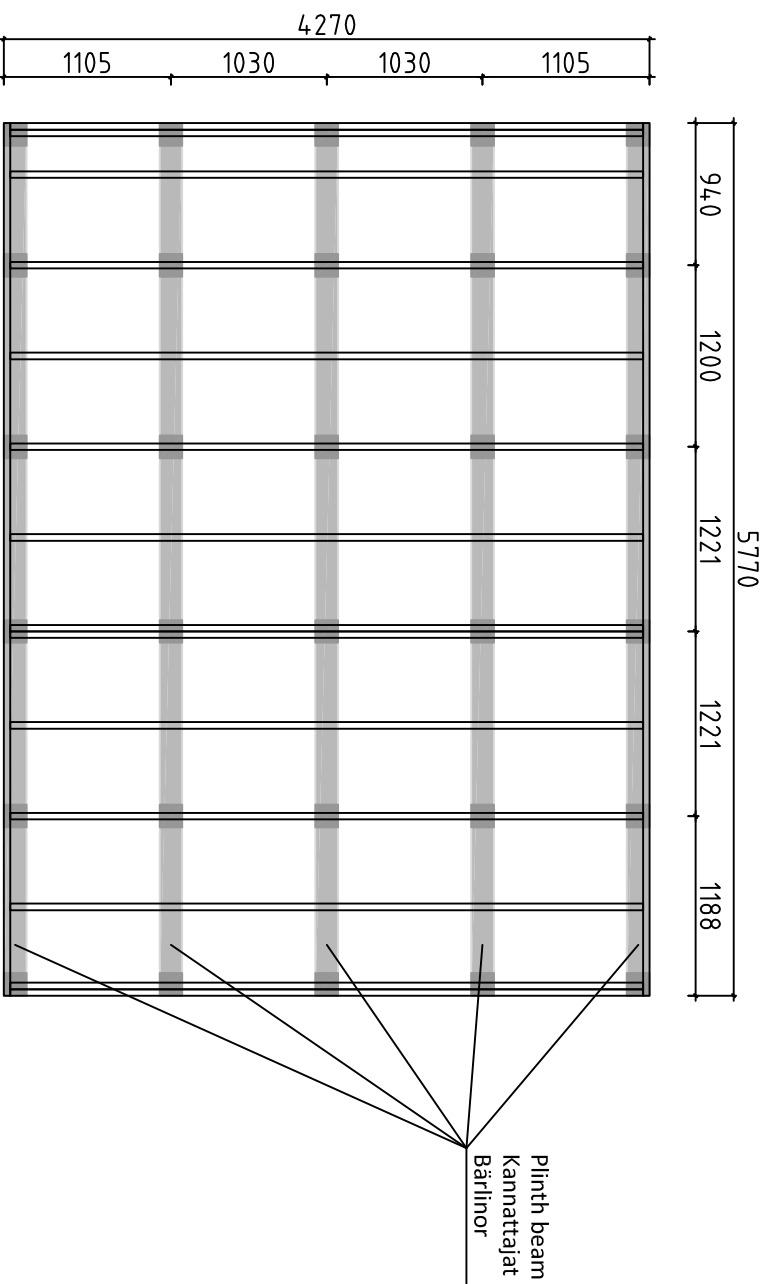

Förslag på alternativ plintplan med bärilinjor och plintar. Bärilinjor 45x95 eller 45x120 och plintar ca 100-200 mm i diameter. (Bärilinjor och plintar ingår ej i leveransen). Används exempelvis murblock, (ingår ej i leveransen) istället för plintar, kan man lägga bärilinjorna platt mot dessa och på det sättet minska höjden på konstruktionen. I denna konstruktion kan man dessutom lägga en "boardskiva" mellan bärilinjorna och golvbjälkarna och på det sättet bära upp bjälklagsisoleringen. Lagg fuktskyddande papp mellan betong och trä

Endotus valtoehtoisesesta jalustasta kannattajilla ja jalolla. Kannattajat 45x95 tai 45x120 ja jalat läpimitataan n. 100-200 mm (kannattajat ja jalat ei ole toimituksessa). Käytettäessä esimerkiksi harkkoja (ei kuulu toimitukseen) jalkojen sijasta, voi kannattajat asettaa lappeelleen niitä vasten ja sillä tavoin vähentää rakenteen korkeutta. Tässä rakenteessa voi lisäksi asettaa levyä kannattajien ja lattiapalkkien väliin ja sillä tavoin kannattaa alapohjan eristystä. Aseta betonin ja puun väliin kosteudelta suojaava pähvi

A proposal for alternative plinth beam layout plan. Plinth beams 45x95 or 45x120 and plinths ca 100-200 mm in diameter (plinth beams and plinths are not included in the kit). For example, by using masonry units (not included in the kit) instead of plinths, one can lay plinth beams flat against the masonry units and in that way reduce the height of the structure. In this construction one can also add "plywood board" between plinth beams. Place cardboard between the concrete and wood to protect from moisture

House	P5843-44 Eva	Sheet	22
Drawing	PLINTPLAN - FOUNDATION PLAN	Scale	1:50
Material		Date	22.11.2017
Drawer	RP	File	P5843-44 Eva Foundation.dwg

#001	3	5980	1
#002	1,3	5980	5
#003	1	5980	1
#004		5980	1
#005	A,C	4480	6
#006	B,C	4480	18
#007	B	4480	1
#008	1,3	3816	2
#009	1,3	3816	2
#010	3	3535	10
#011	1,3	2864	2
#012	1,3	2864	2
#013	1,2	2636	26
#014	1,2	2636	2
#015	2	2636	1
#016	B,C	2565	2
#017	1	2344	10
#018	1	2344	1
#019	C	1853	2
#020	C	1853	4
#021	3	1662	5
#022	B	1640	2
#023	B	1640	6
#024	C	1582	2
#025	A,B,C	1424	3
#026	B	1369	2
#027	A	1357	2
#028	A	1323	2
#029	B	1313	15
#030	A	1283	2
#031	A,B,C	1194	3
#032	A	1092	2
#033	C	1011	2
#034	1	993	10
#035	B	798	2
#036	1,3,B	763	25
#037	1	471	5
#038	3,A	435	45
#039	B	384	15
#040	A,B,C	224	6
#041	A,B,C	168	12