

Linnea-44 ISO

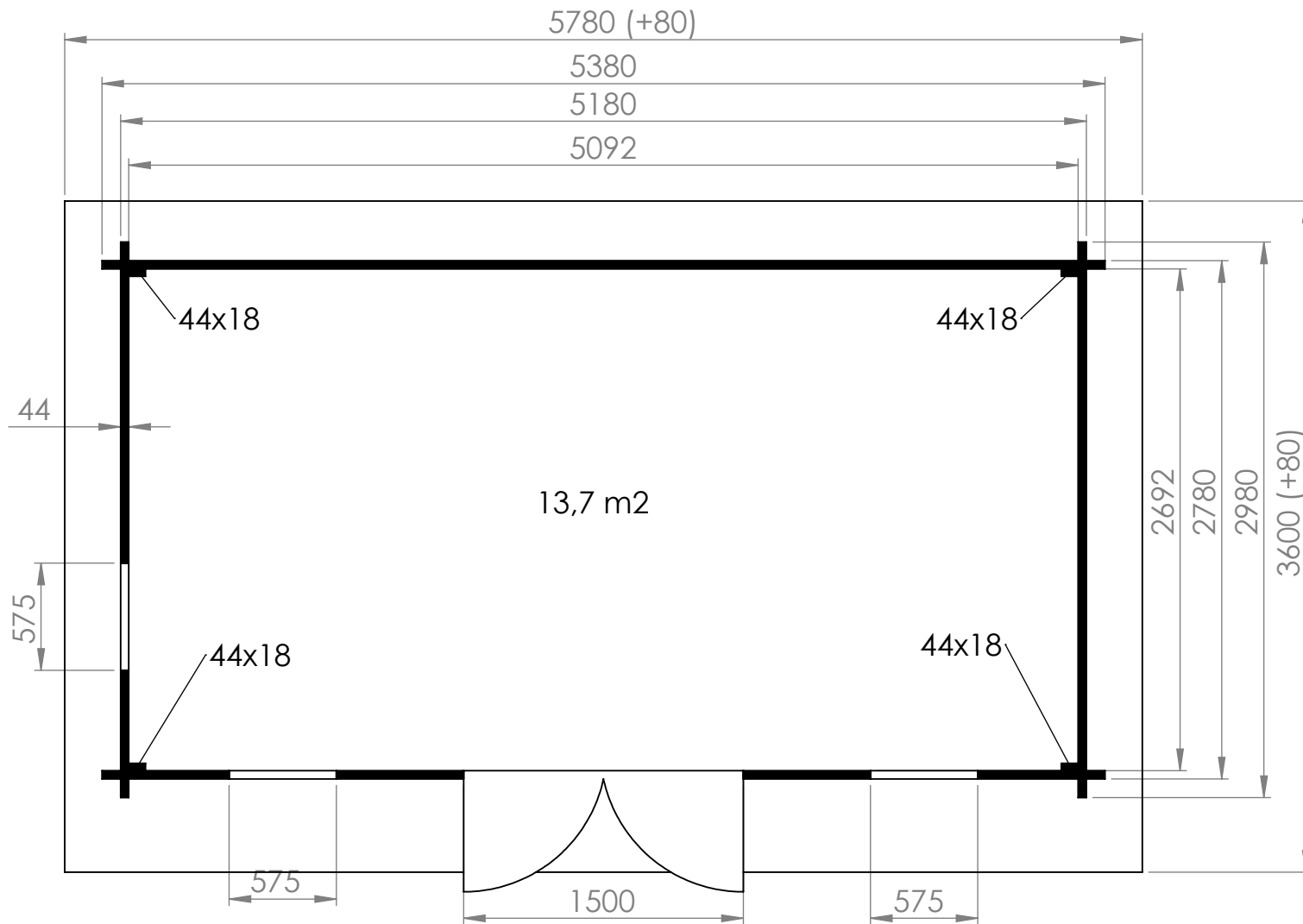

20.05.2019

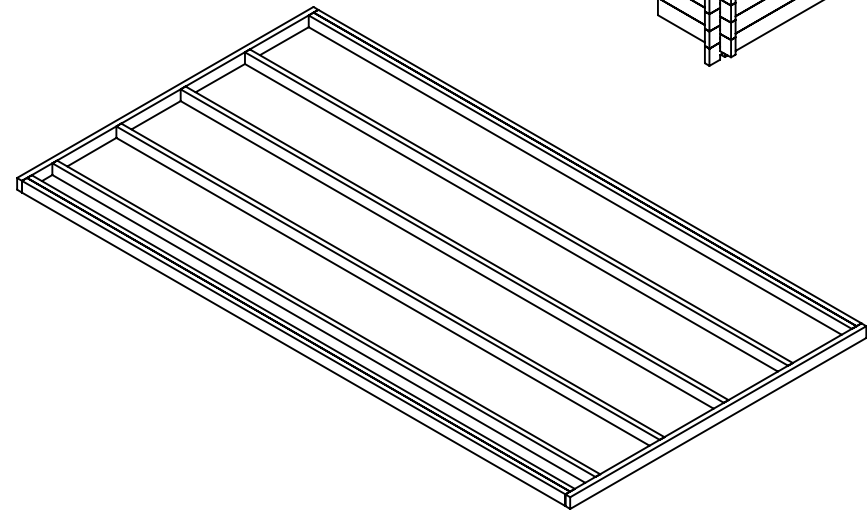
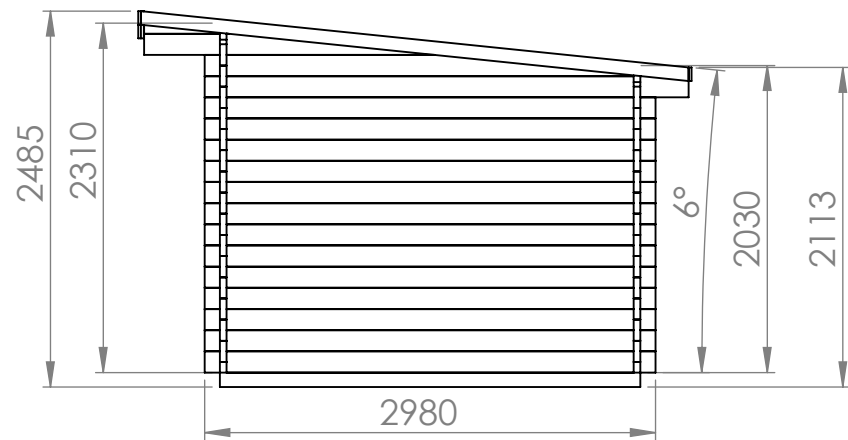
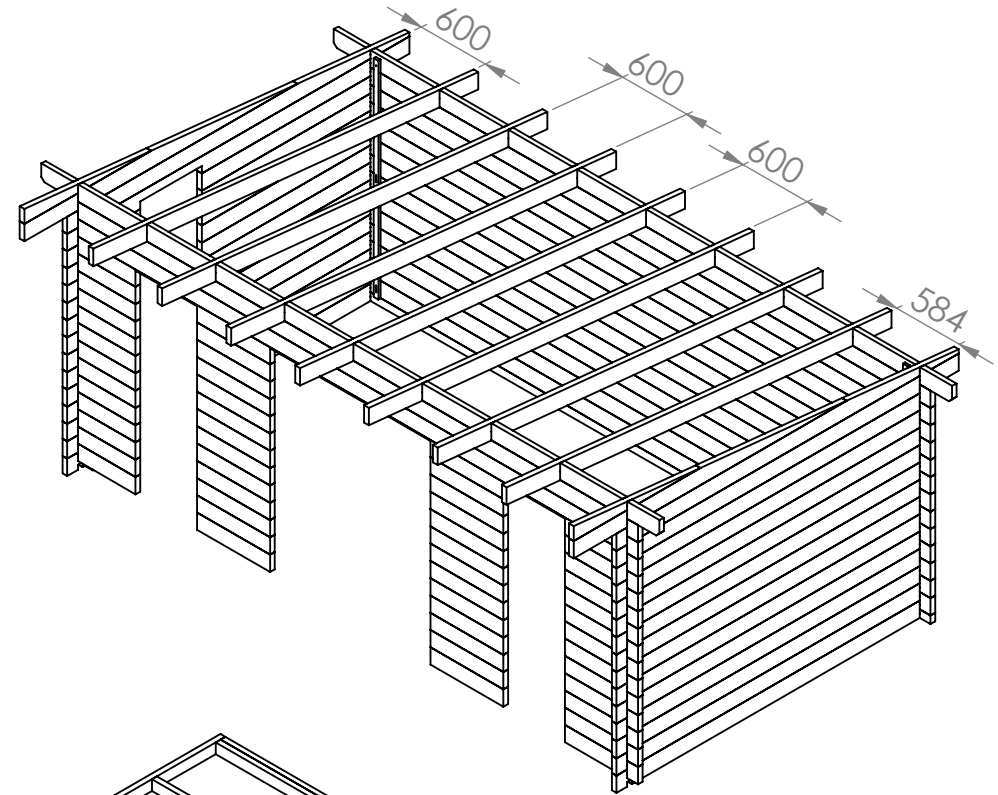
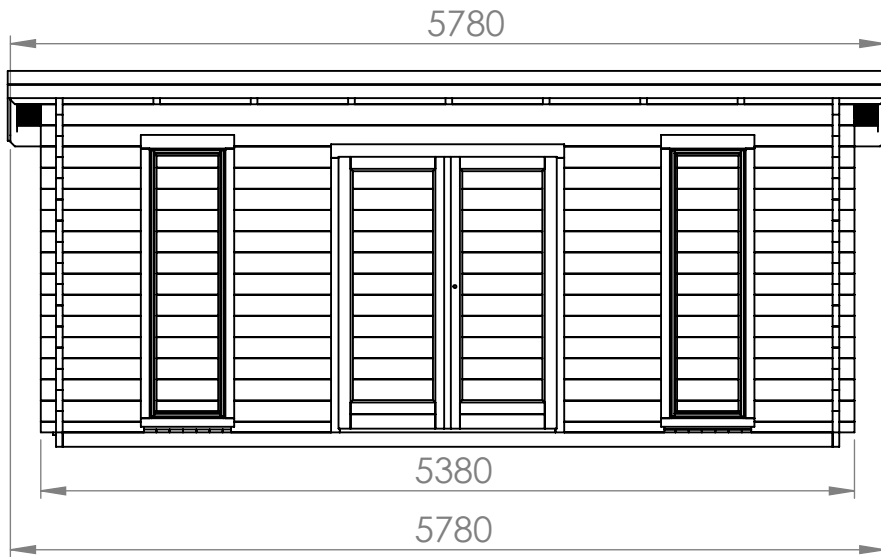

Detta är ett förslag för hur man kan placera plintarna (100- 200 mm i diameter) för golvbjälklaget. Golvbjälkarna är med i byggsatsen, men inte plintarna. Använder man exempelvis 500-600mm långa murblock så kan man halvera antalet punkter. Lägg fuktskyddande papp mellan betong och trä



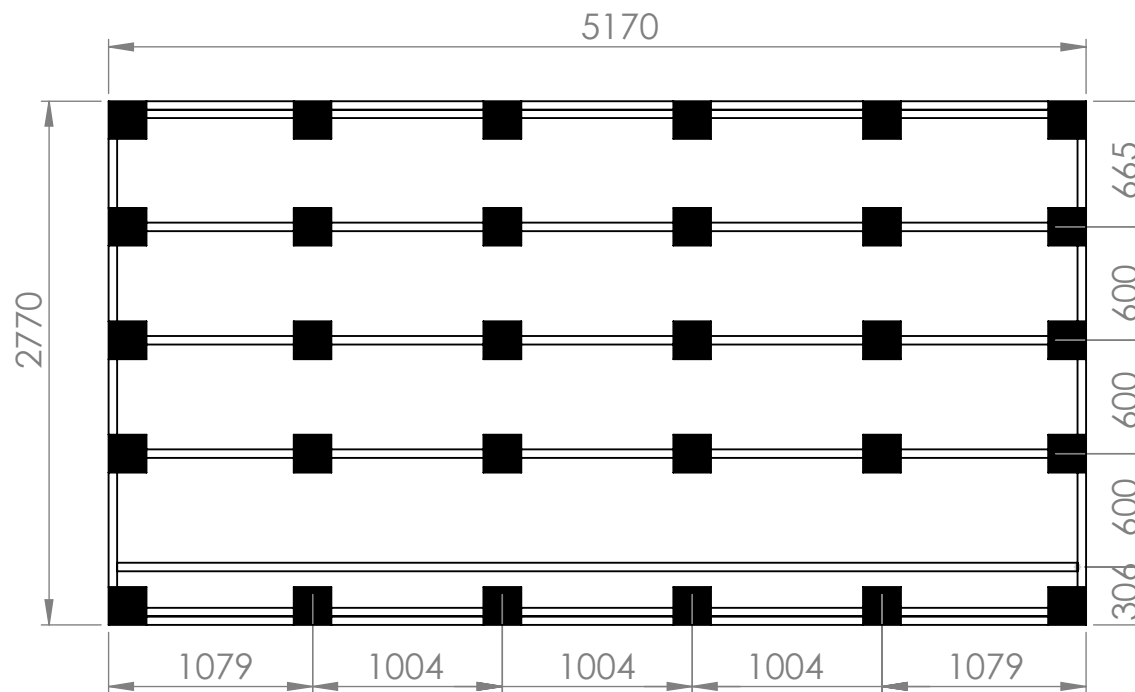

Tämä on ehdotus siitä, miten (100-200 mm läpimittaiset) jalat voidaan sijoittaa alapohjaa varten. Lattiapalkit ovat rakennussarjassa, mutta jalvoja ei ole. Kun käytetään esimerkiksi 500-600 mm pitkiä harkkoja, voidaan pisteiden määrä puolittaa. Aseta betonin ja puun väliin kosteudelta suojaava pahvi

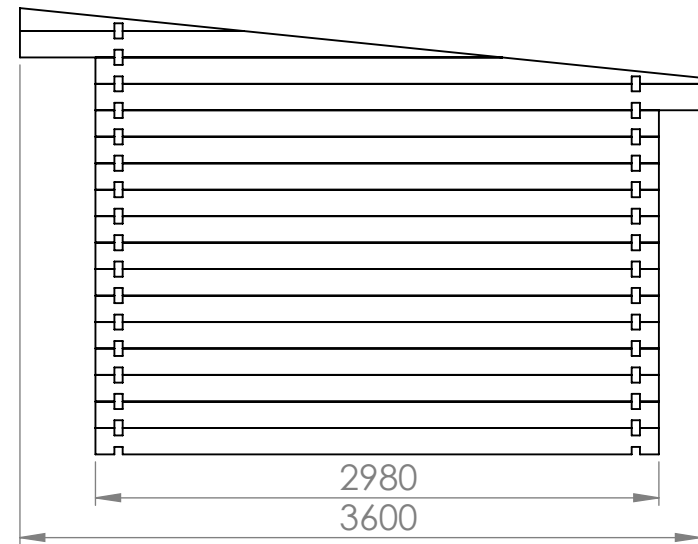
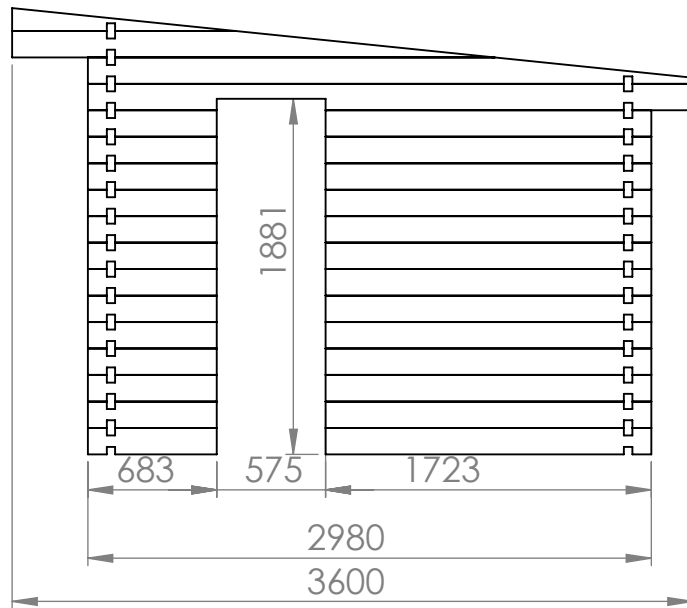
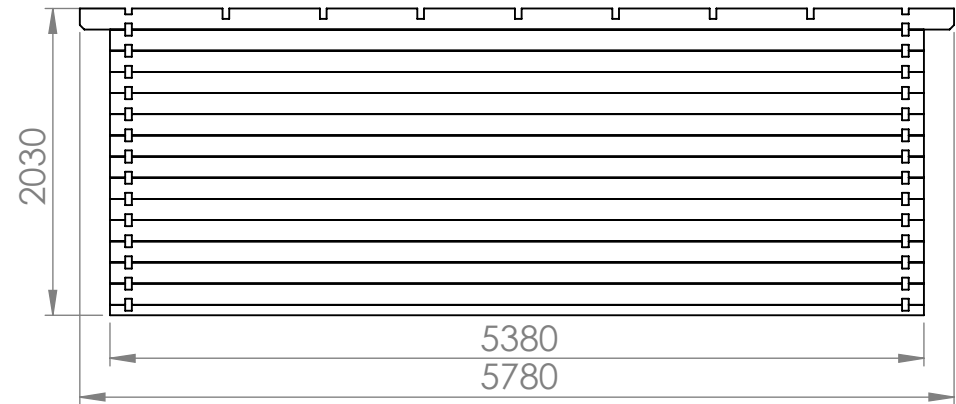
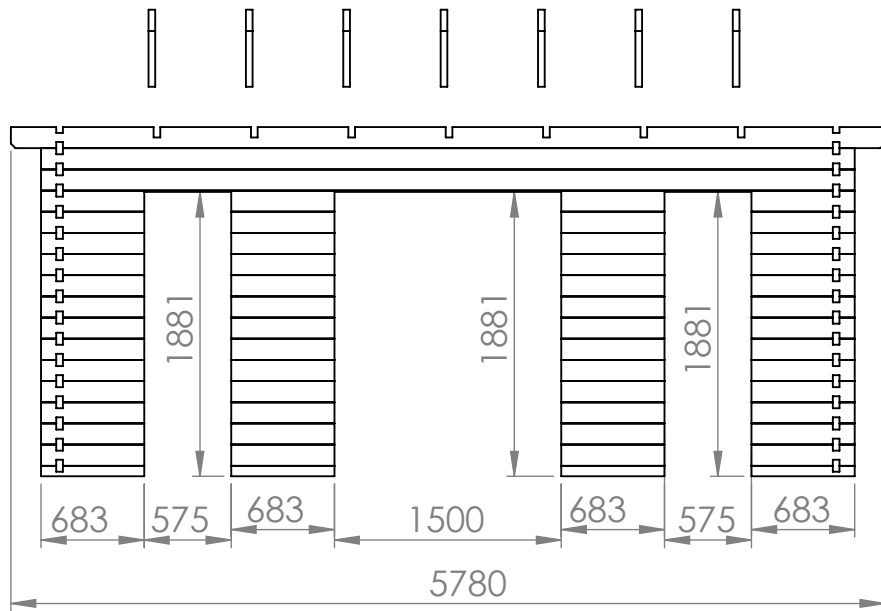
A proposal for placing plinths (100-200 mm in diameter) for floor beams. Floor beams are provided in the kit but plinths are not included. For example, by using 500-600 mm long masonry units, one can reduce the number of points 50%. Place cardboard between the concrete and wood to protect from moisture

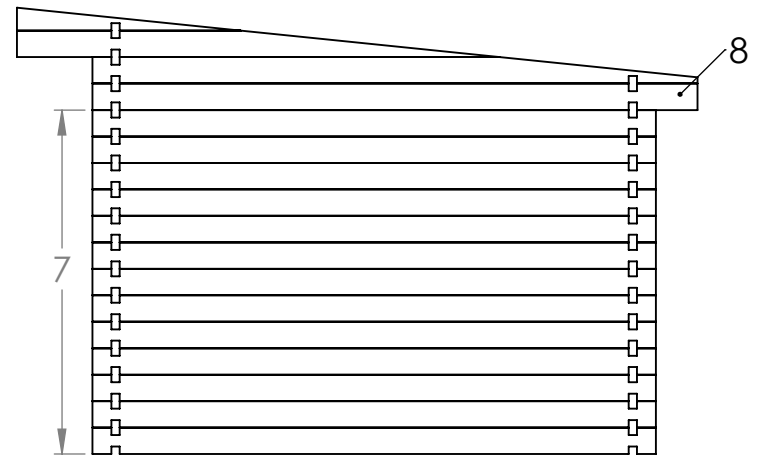
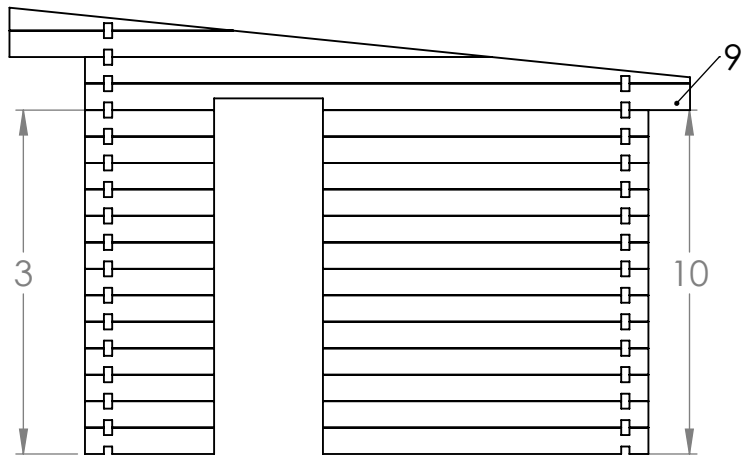
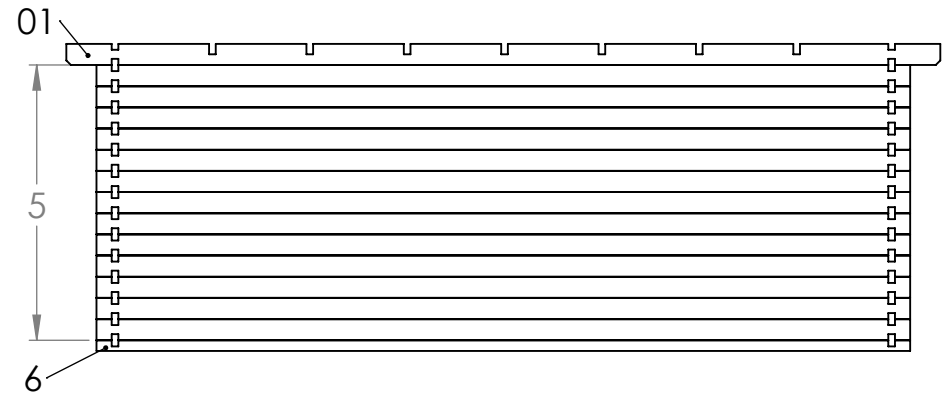
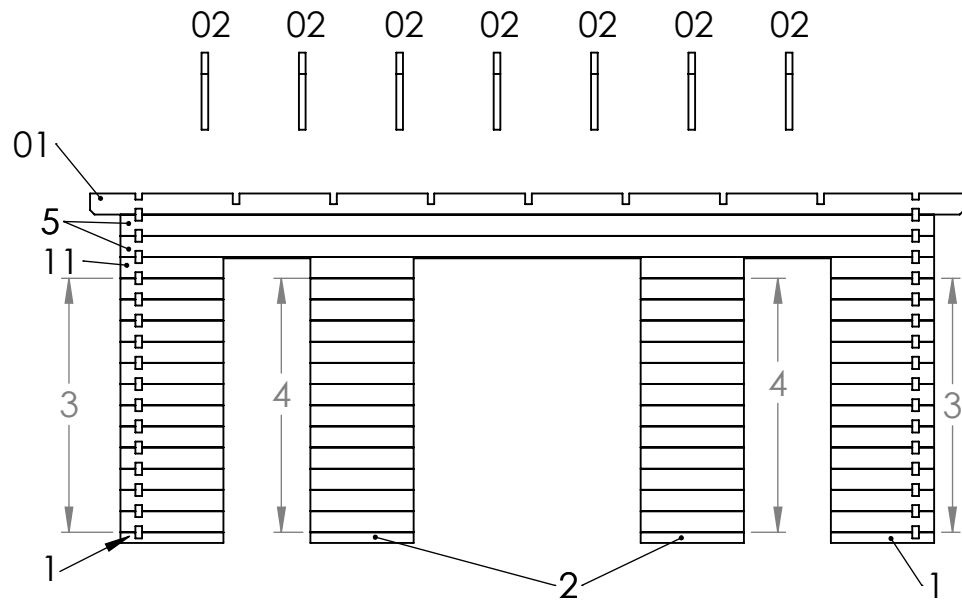

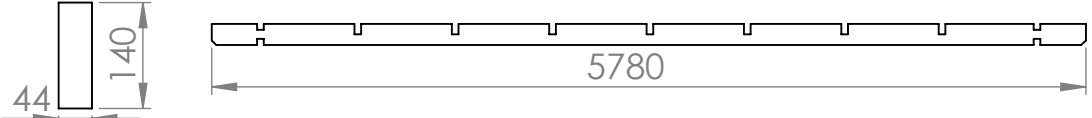
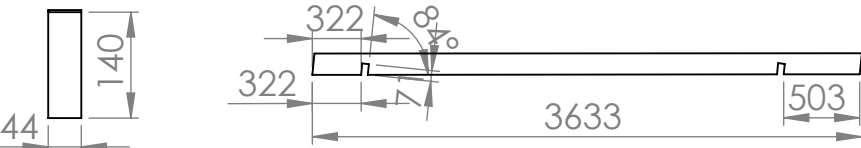
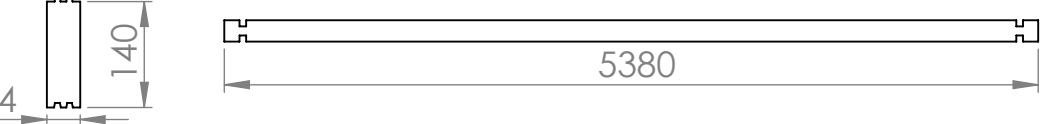
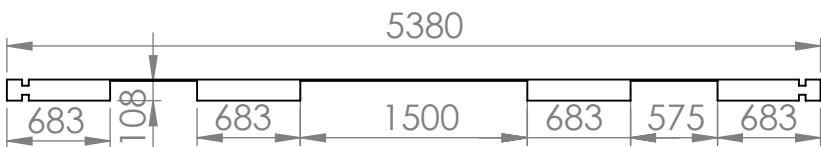
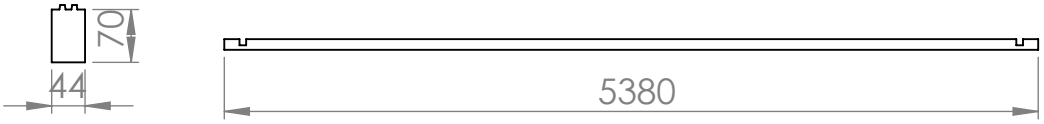

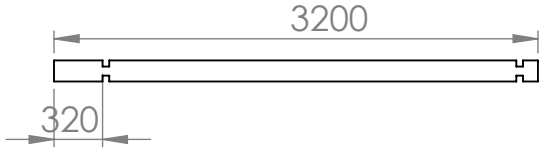
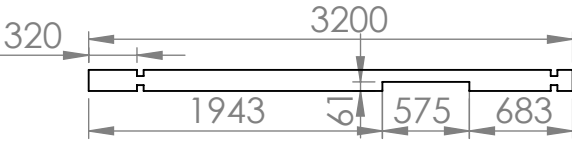

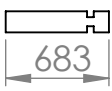
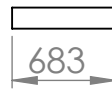
Num	Qty	Linnea-44 ISO	22.05.2019
①	2		
②	7		
⑤	15		
⑪	1		
⑥	1		
1	1		extra detail
⑧	1		
⑨	1		
⑦	13		
⑩	13		
③	37		
④	24		

Num

Qty

Linnea-44 ISO

22.05.2019

②

2

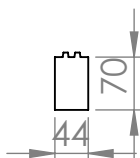

①



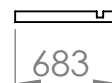
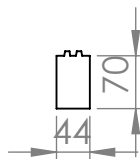

2

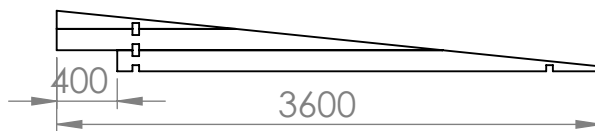



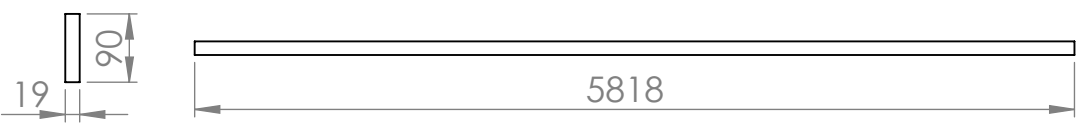
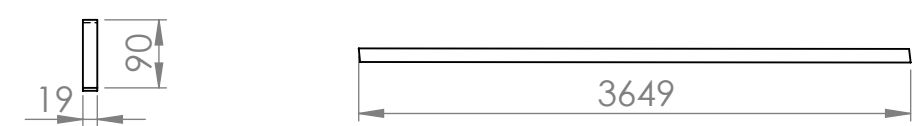
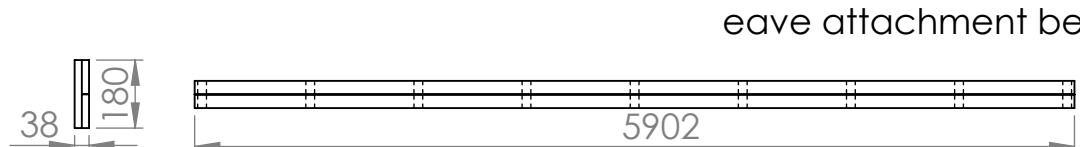
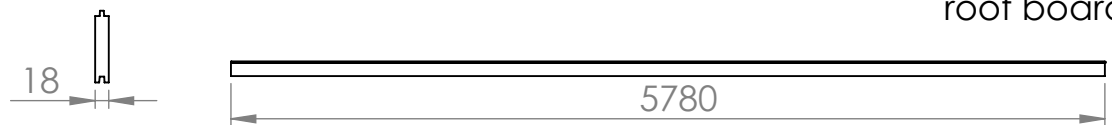
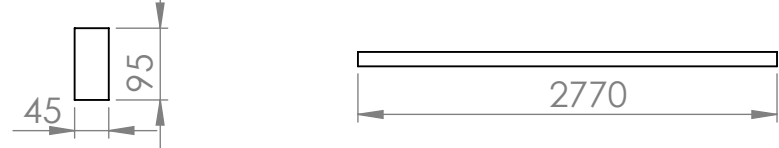
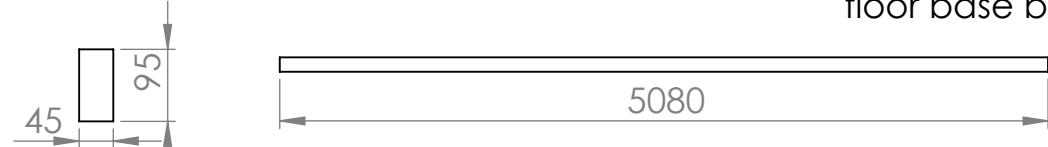
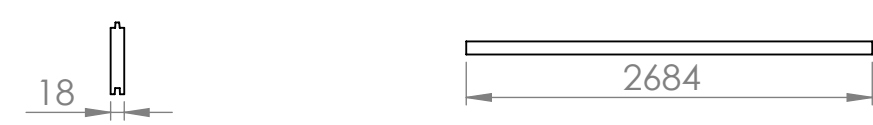

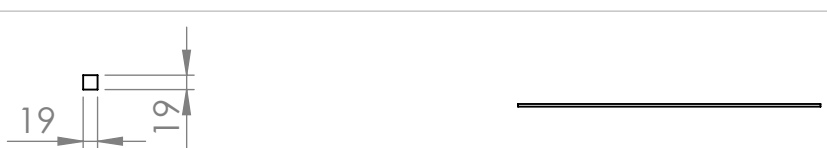
2



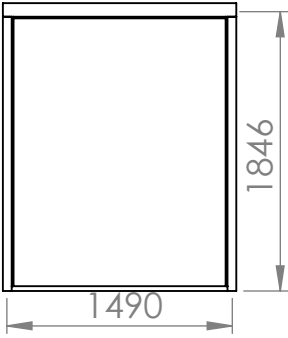
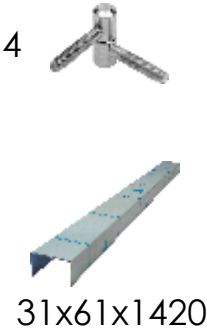

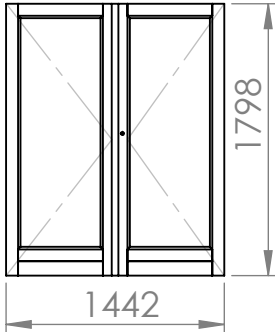
Num	Qty	Linnea-44 ISO	22.05.2019
			eave boards
	1		
	2		
	1		
18x88	43		roof boards
18x118	33		
18x140	28		
	2		
	8		
18x88	60		floor boards
18x118	45		
18x140	38		
	2		
	2		
			
	2		

Num	Qty	Linnea-44 ISO	22.05.2019
	1	 <p>attached</p>  <p>4</p> <p>31x61x1420</p>	<p>in package</p>  <p>4</p> <p>4,5x80</p>
	1	  <p>2</p>	
	3	