

House	Madelaideine 70	Sheet	1
Drawing	3D	Scale	
Material	70x135	Date	26.01.2021
Drawer	RP	File	Madelaideine 70 3D.dwg

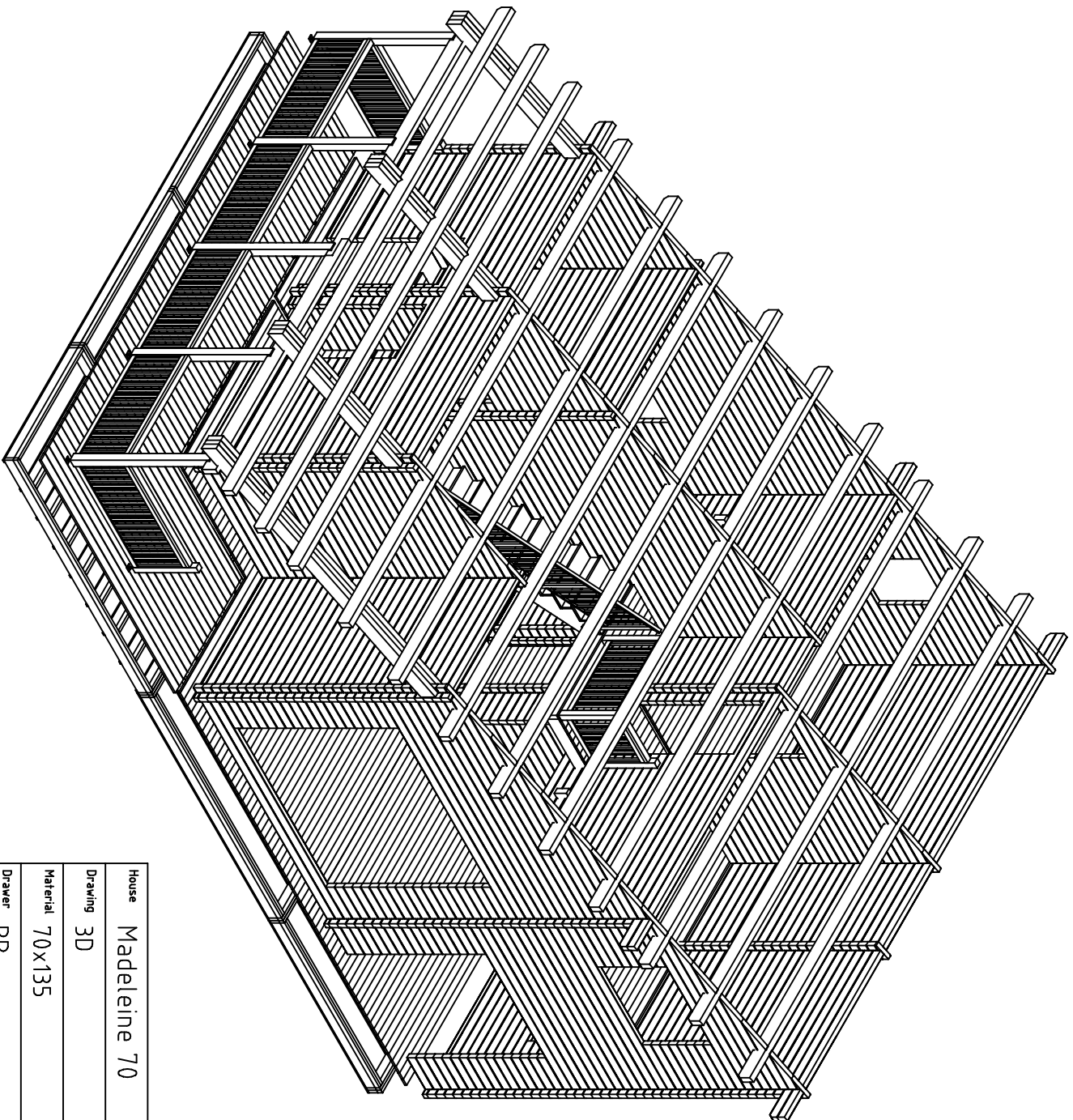

House	Madelineine 70	Sheet	2
Drawing	3D	Scale	
Material	70x135	Date	26.01.2021
Drawer	RP	File	Madelineine 70 3D.dwg

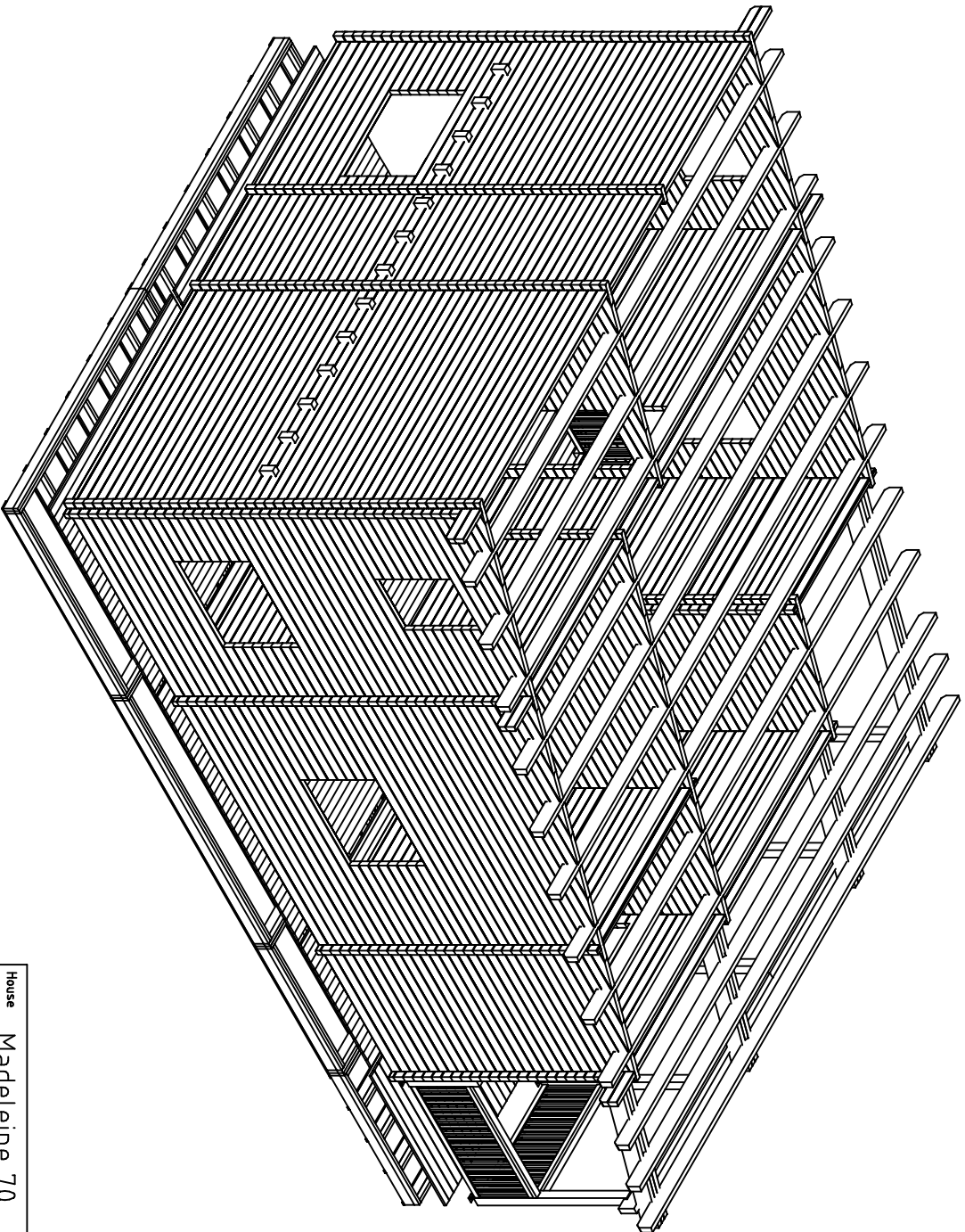

House	Madeline 70	Sheet	3
Drawing	3D	Scale	
Material	70x135	Date	26.01.2021
Drawer	RP	File	Madeline 70 3D.dwg

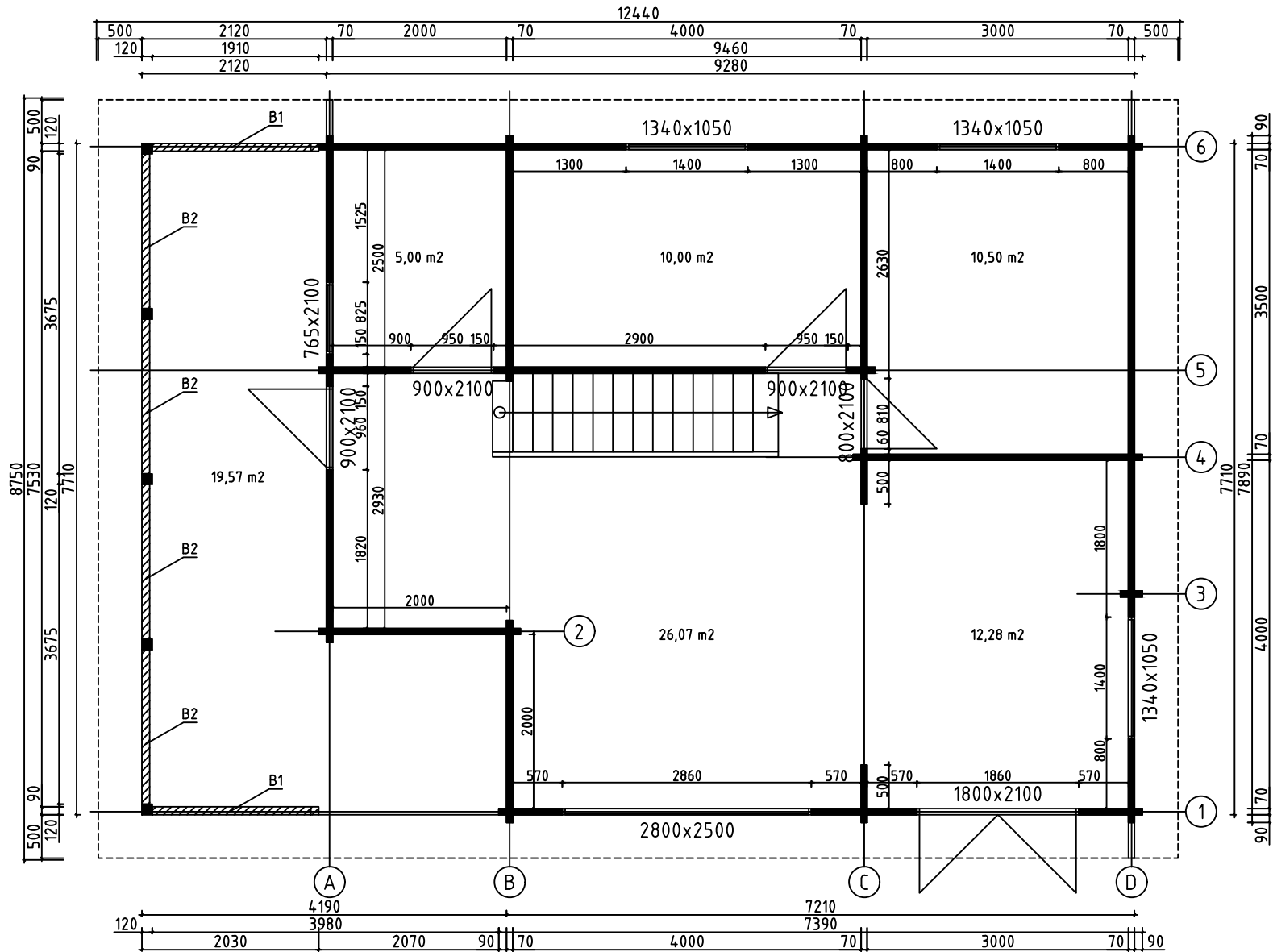

House	Madeleine 70	Sheet	4
Drawing	PLAN-SUUNNITELMA-PLANEN	Scale	1:70
Material	70x135	Date	26.01.2021
Drawer	RP	File	Madeleine 70.dwg

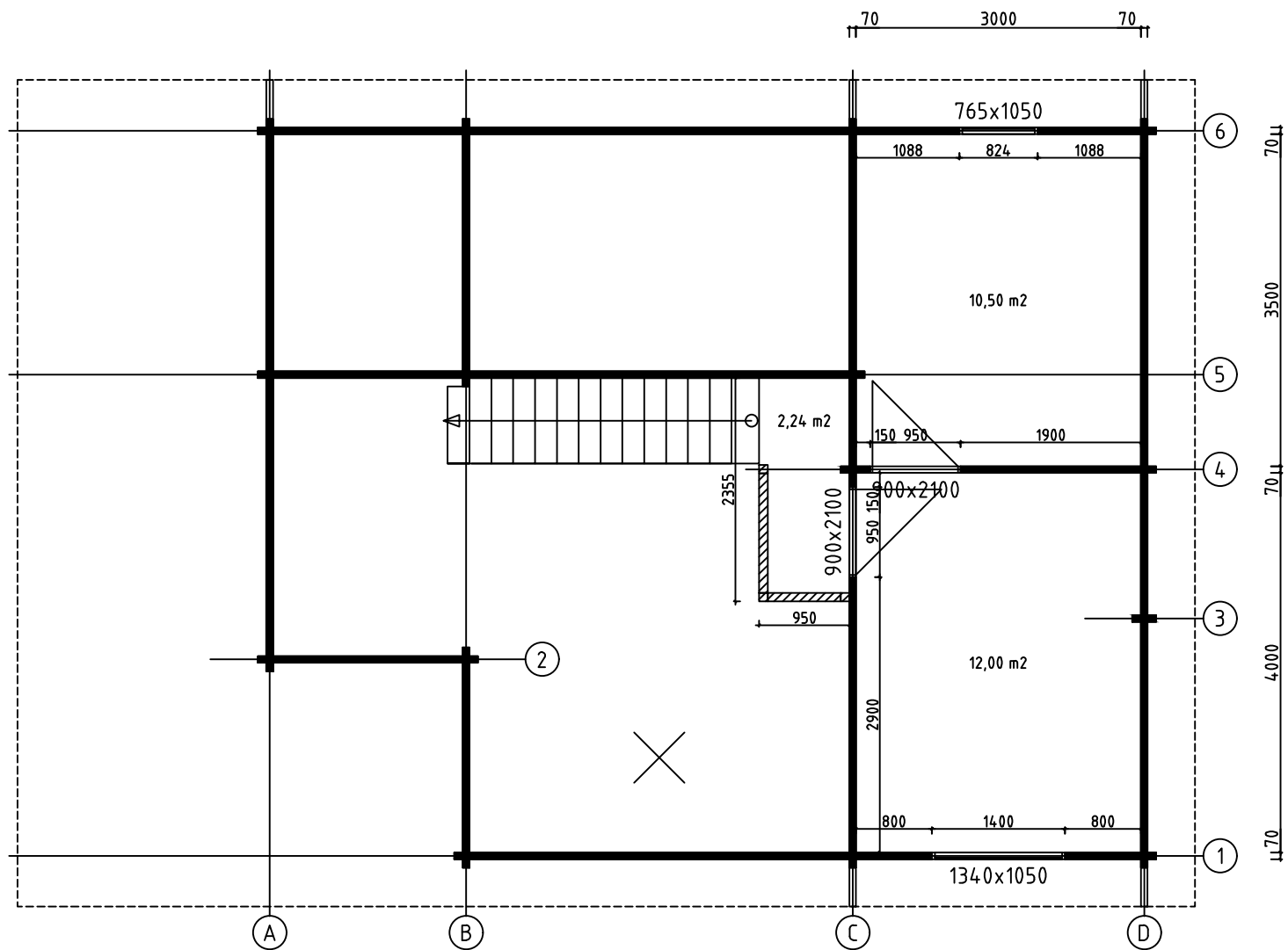

House	Madeleine 70	Sheet	5
Drawing	LOFT FLOOR-PARVI LATTIA-LOFT GOLV	Scale	1:70
Material	70x135	Date	26.01.2021
Drawer	RP	File	Madeleine 70.dwg

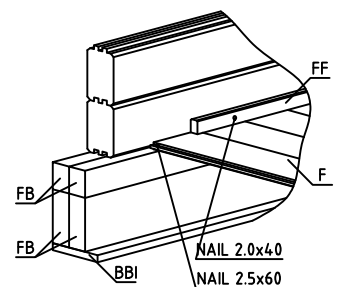
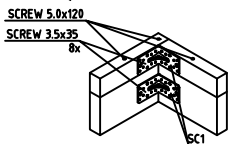
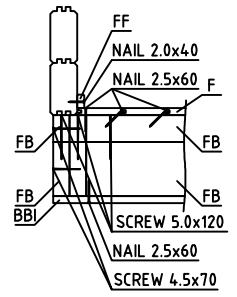
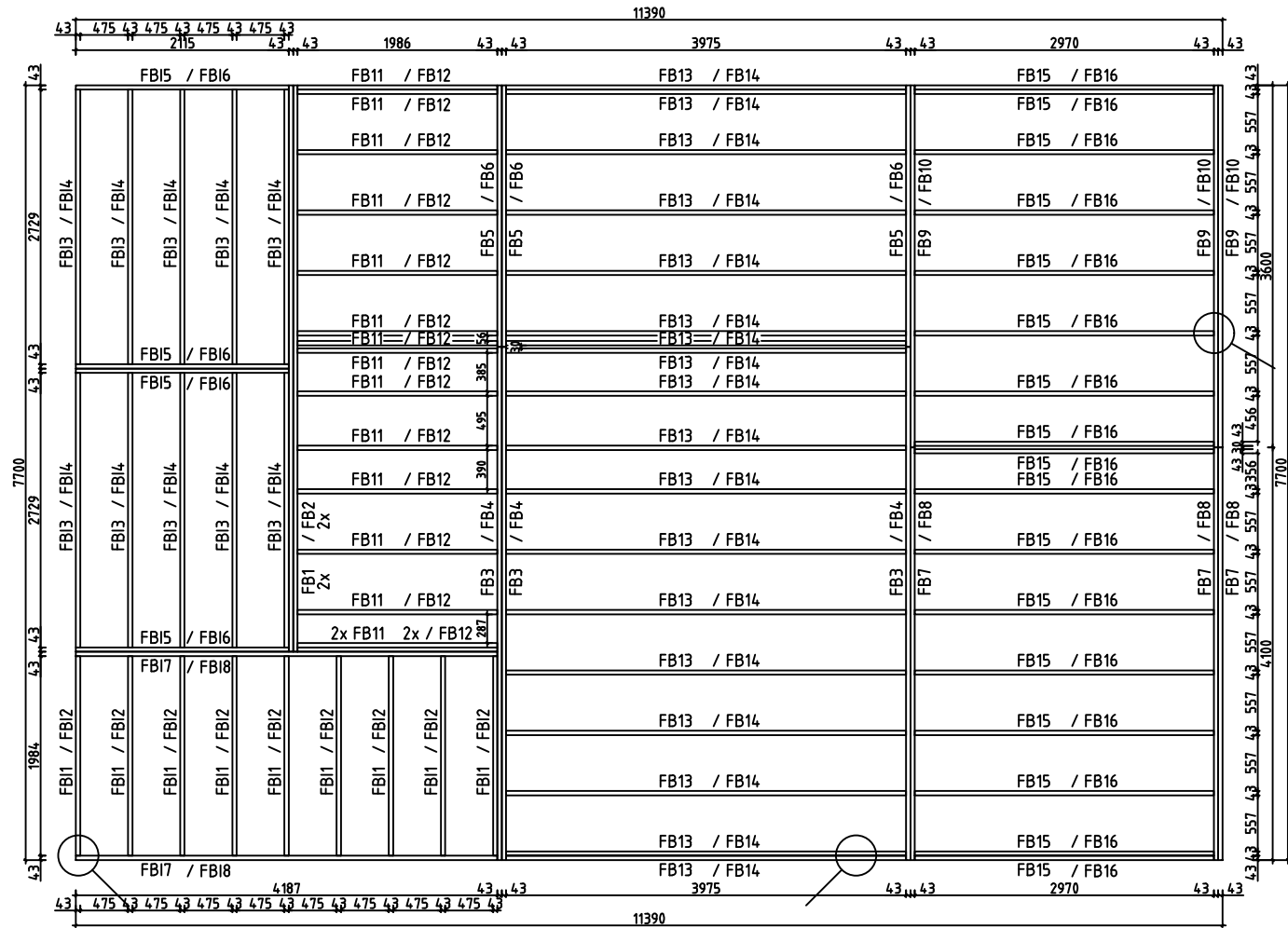

House	Madeleine 70	Sheet	6
Drawing	FLOORBEAMS-LATTIAPALKIT-GOLVBJÄLKAR	Scale	1:70
Material	43x140, 43x70	Date	26.01.2021
Drawer	RP	File	Madeleine 70.dwg

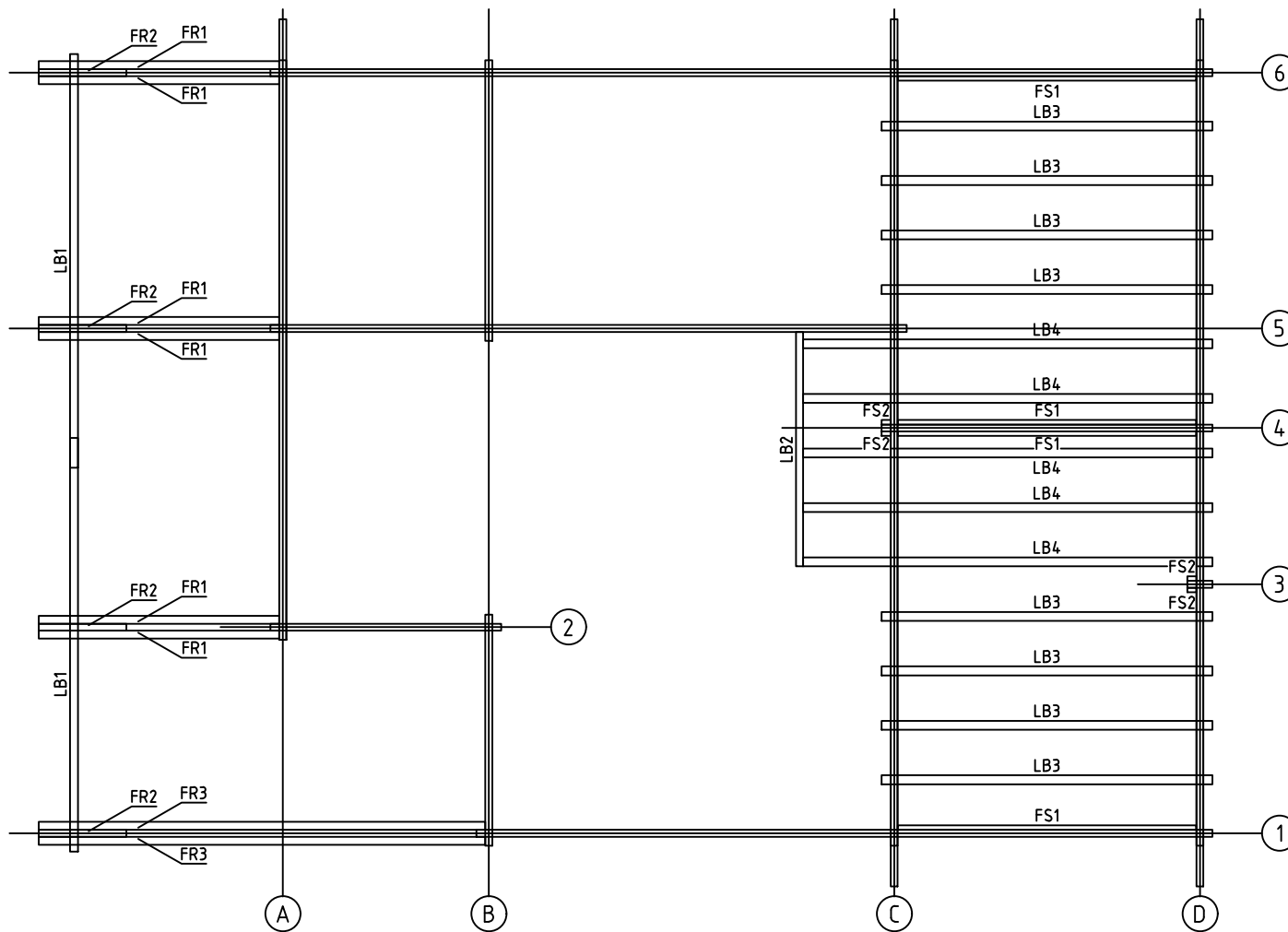

House	Madeleine 70	Sheet	7
Drawing	LOFT FLOOR BEAMS - PARVIA LATTIAPALKIT - LOFT GOLVBJÄLKAR	Scale	1:70
Material	80x220, 70x220, 90x190, 45x70	Date	26.01.2021
Drawer	RP	File	Madeleine 70.dwg

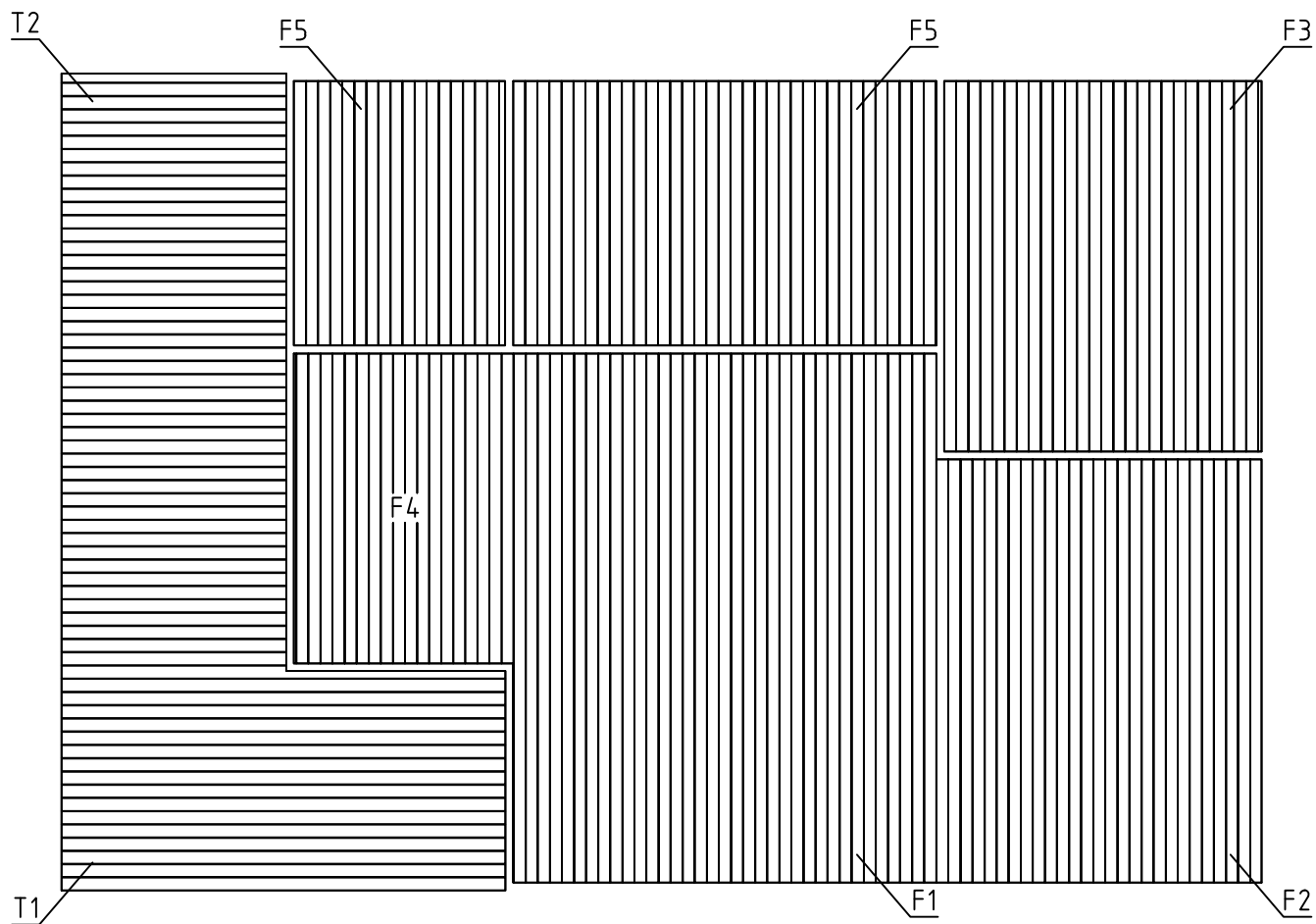

FLOORBOARD-LATTIALAUTA-GOLVBRÄDE

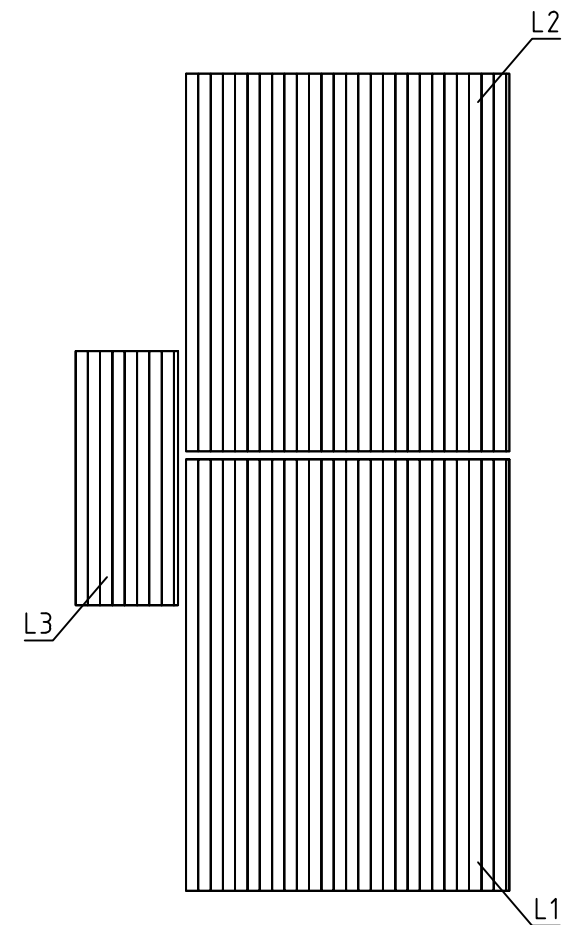

LOFT FLOORBOARD - PARVIA  
LATTIALATTIA - LOFT GOLVBRÄDE

House	Madeleine 70	Sheet	8
Drawing	FLOORBOARD-LATTIALAUTA-GOLVBRÄDE	Scale	1:70
Material	28x114, 28x120	Date	26.01.2021
Drawer	RP	File	Madeleine 70.dwg



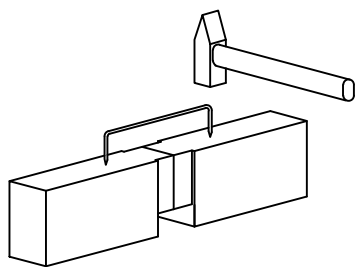
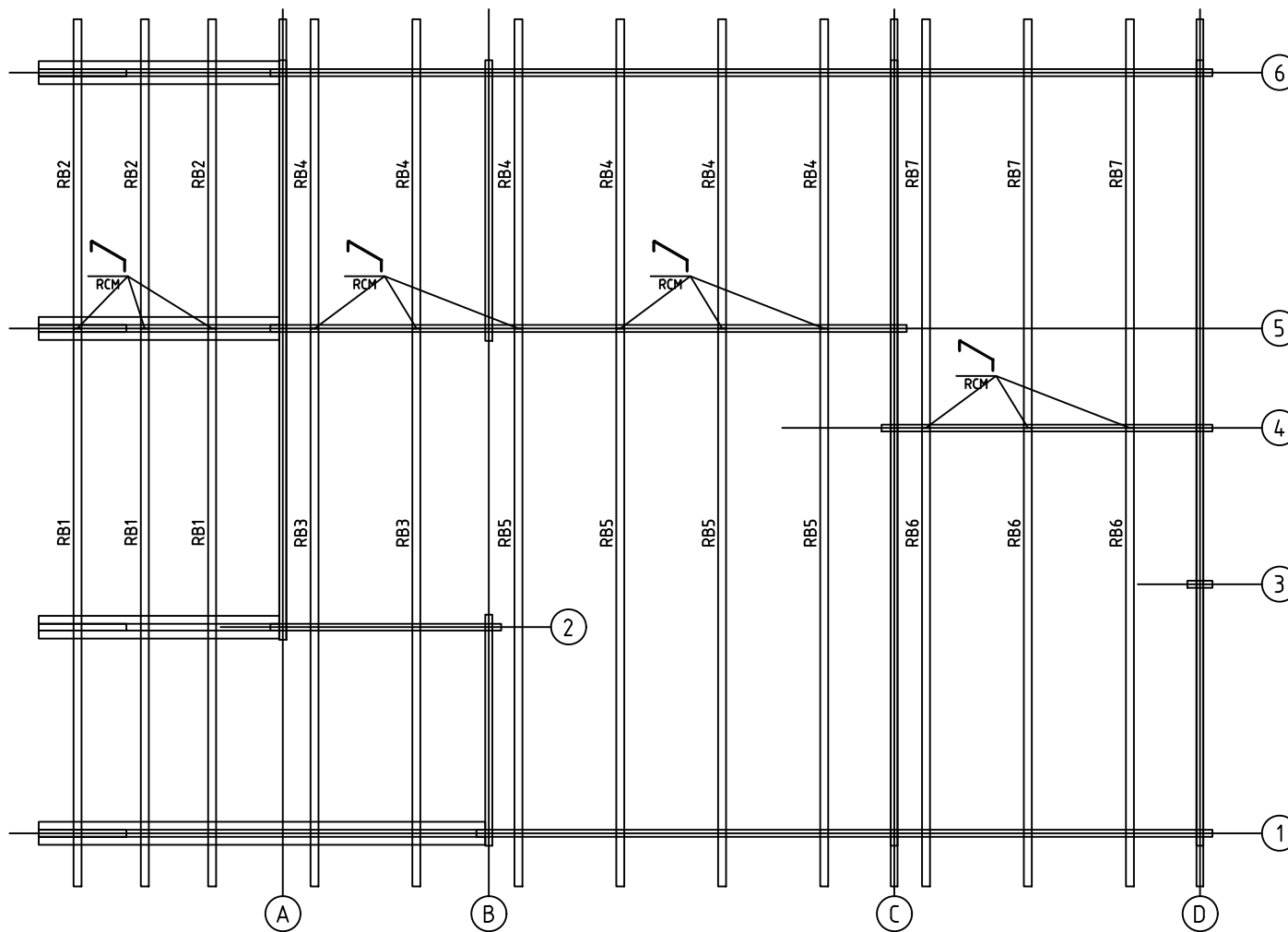

House	Madeleine 70	Sheet	9
Drawing	PURLINS-KATTO-ORRET-TAKÅSAR	Scale	1:70
Material	80x220	Date	26.01.2021
Drawer	RP	File	Madeleine 70.dwg

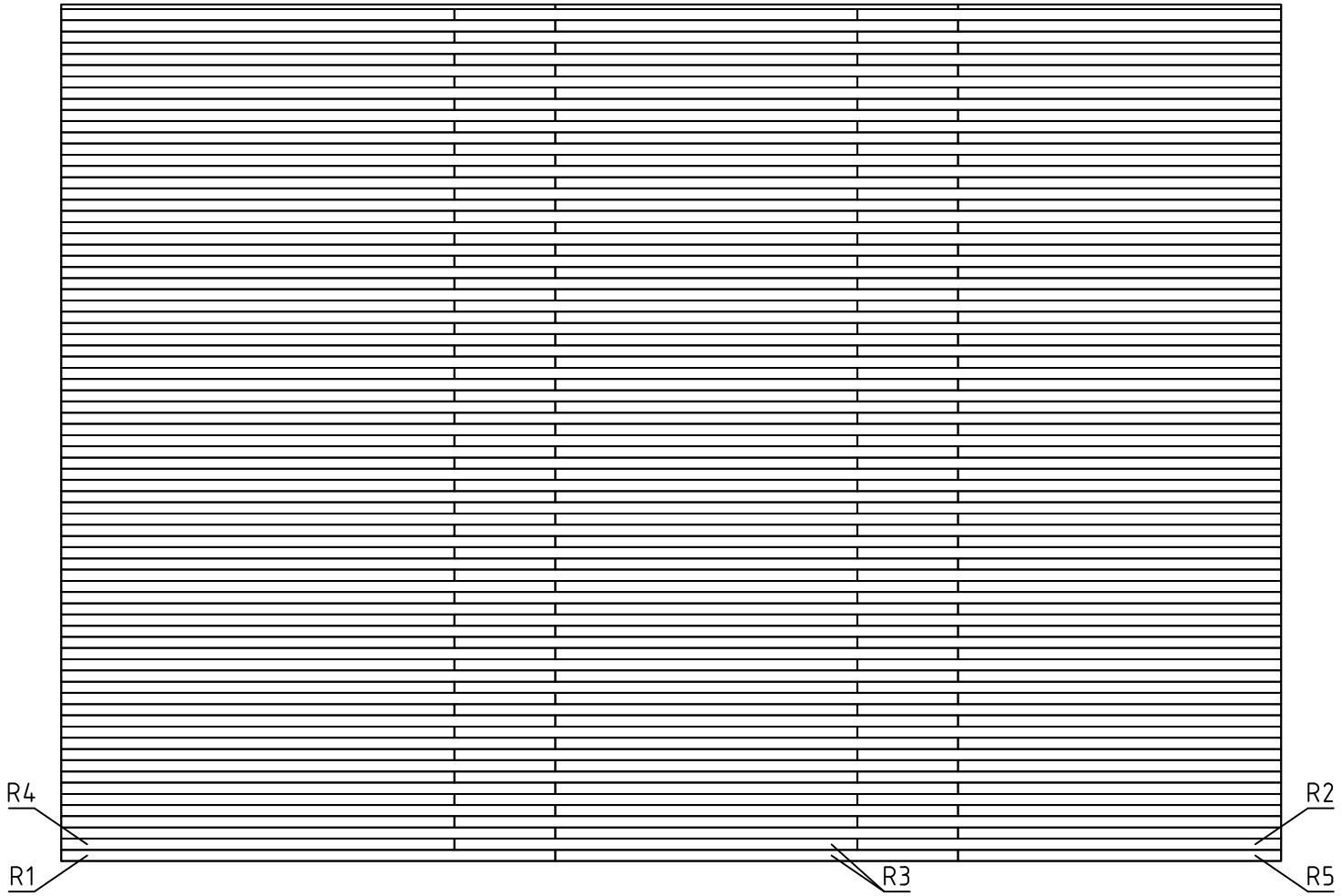

House	Madeleine 70	Sheet	10
Drawing	ROOFBOARD - KATTOLAUTA - TAKBRÄDE	Scale	1:70
Material	18x114	Date	26.01.2021
Drawer	RP	File	Madeleine 70.dwg

Wall-Seinä-Vägg A ↑

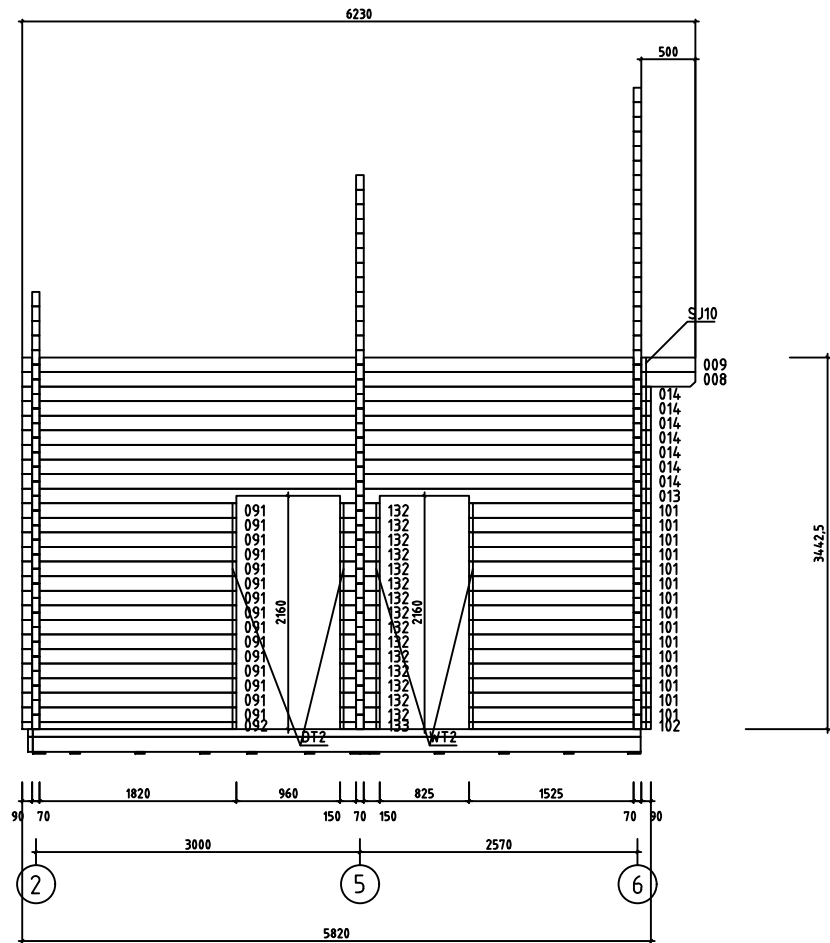

House	Madeleine 70	Sheet	11
Drawing	WALL-SEINÄ-VÄGG A	Scale	1:70
Material	70x135	Date	26.01.2021
Drawer	RP	File	Madeleine 70.dwg

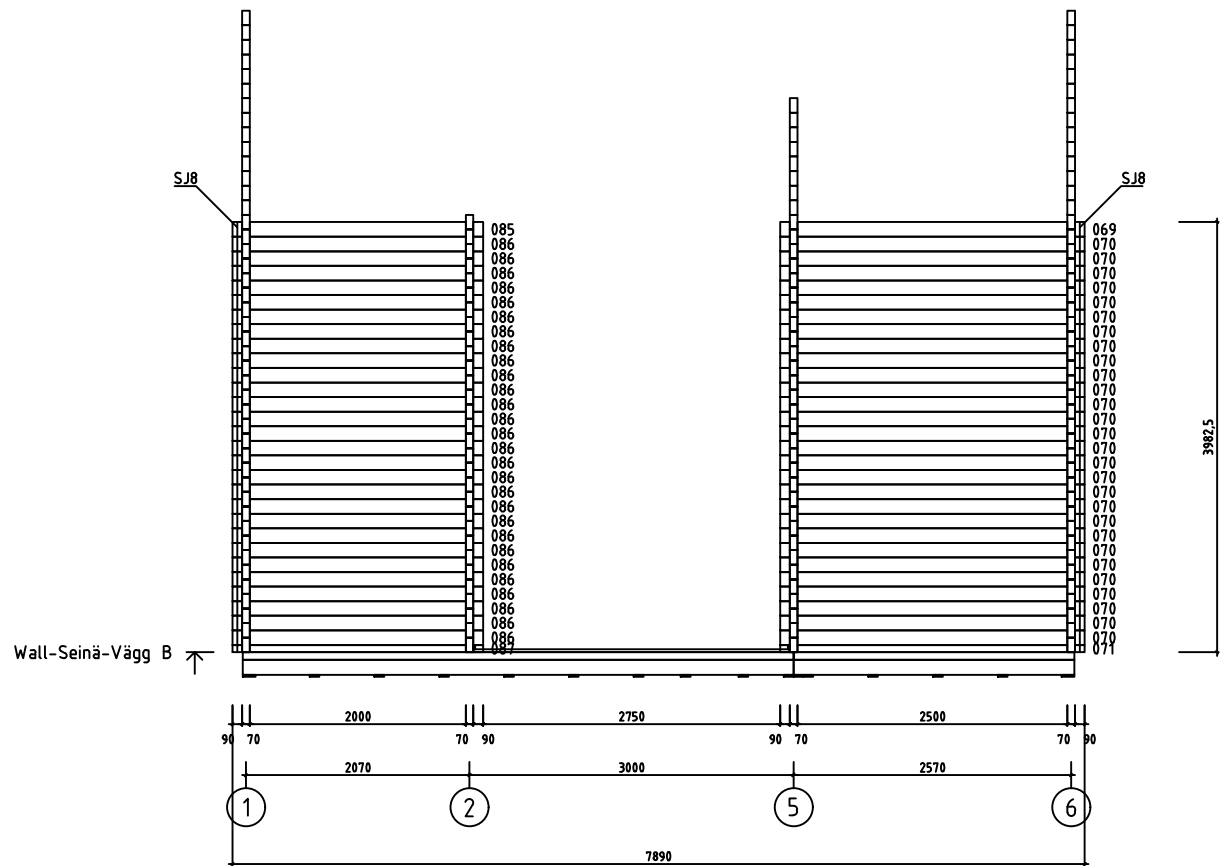

House	Madeleine 70	Sheet	12
Drawing	WALL-SEINÄ-VÄGG B	Scale	1:70
Material	70x135	Date	26.01.2021
Drawer	RP	File	Madeleine 70.dwg

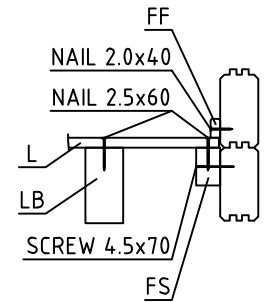
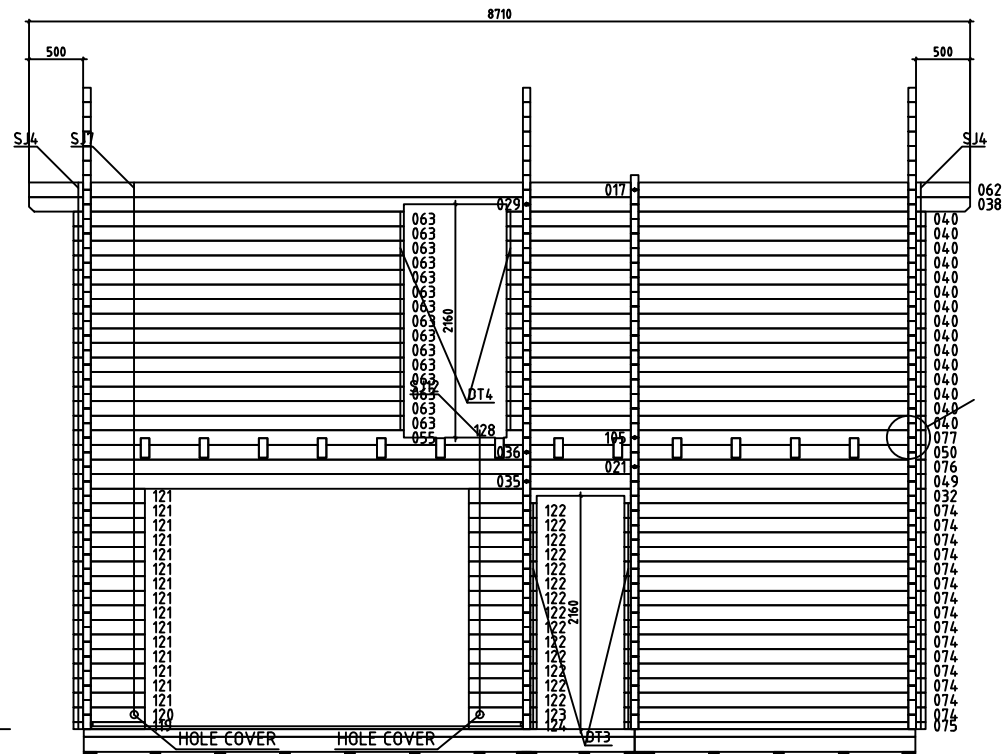

Wall-Seinä-Vägg C ↗

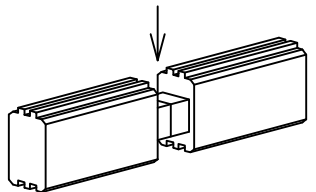
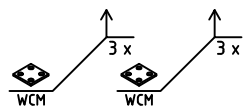
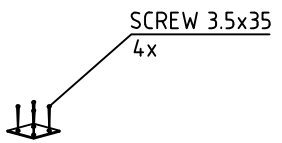
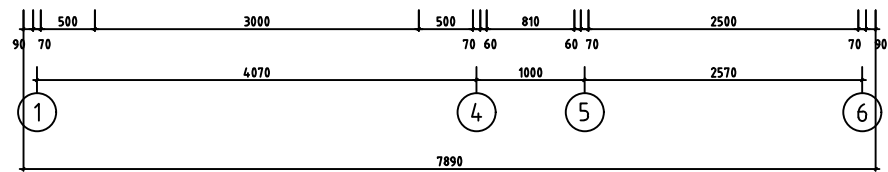

House	Madeleine 70	Sheet	13
Drawing	WALL-SEINÄ-VÄGG C	Scale	1:70
Material	70x135	Date	26.01.2021
Drawer	RP	File	Madeleine 70.dwg

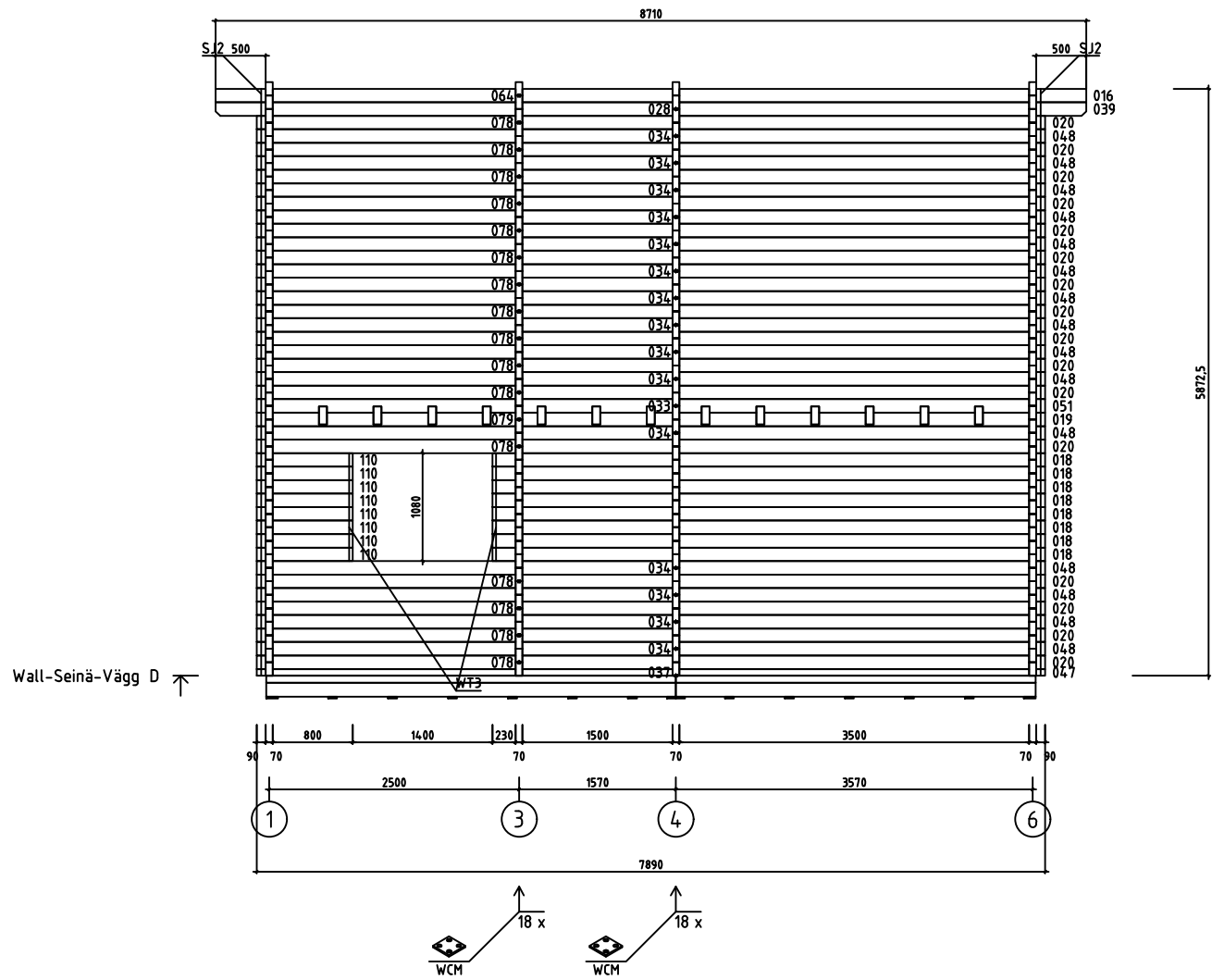

House	Madeleine 70	Sheet	14
Drawing	WALL-SEINÄ-VÄGG D	Scale	1:70
Material	70x135	Date	26.01.2021
Drawer	RP	File	Madeleine 70.dwg







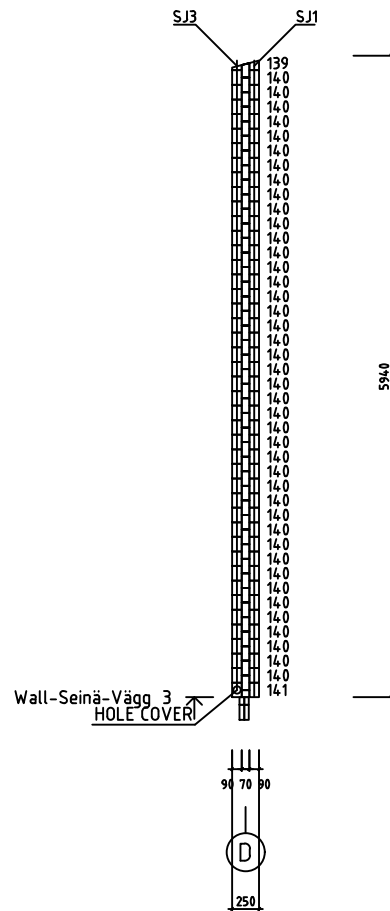

House	Madeleine 70	Sheet	17
Drawing	WALL-SEINÄ-VÄGG 3	Scale	1:70
Material	70x135	Date	26.01.2021
Drawer	RP	File	Madeleine 70.dwg



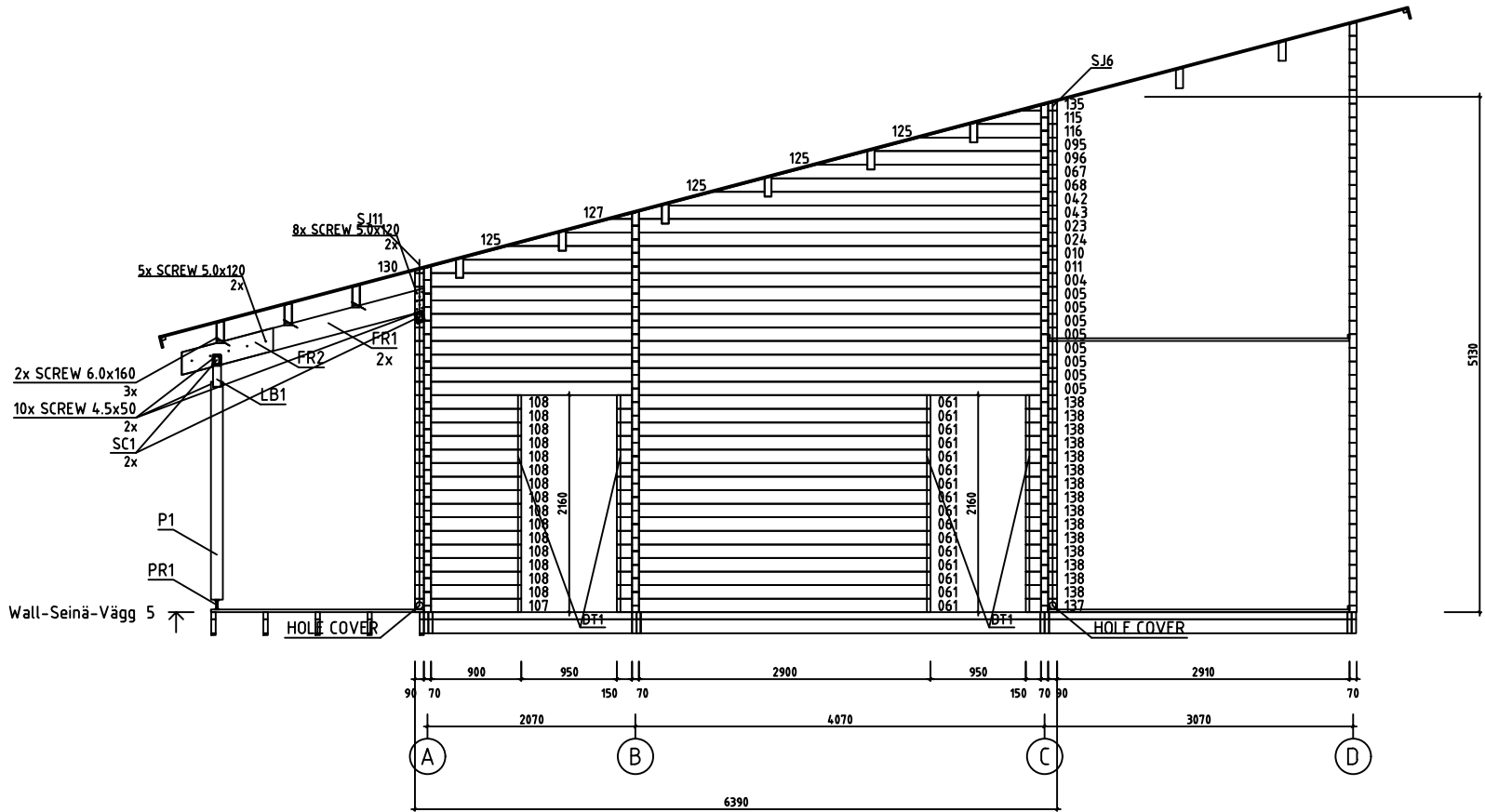

House	Madeleine 70	Sheet	19
Drawing	WALL-SEINÄ-VÄGG 5	Scale	1:70
Material	70x135	Date	26.01.2021
Drawer	RP	File	Madeleine 70.dwg

