

Views and ground plan – Fasader och grundplan – Julkisivut ja pohjapiirustus

Roof MAX 100kg/m²

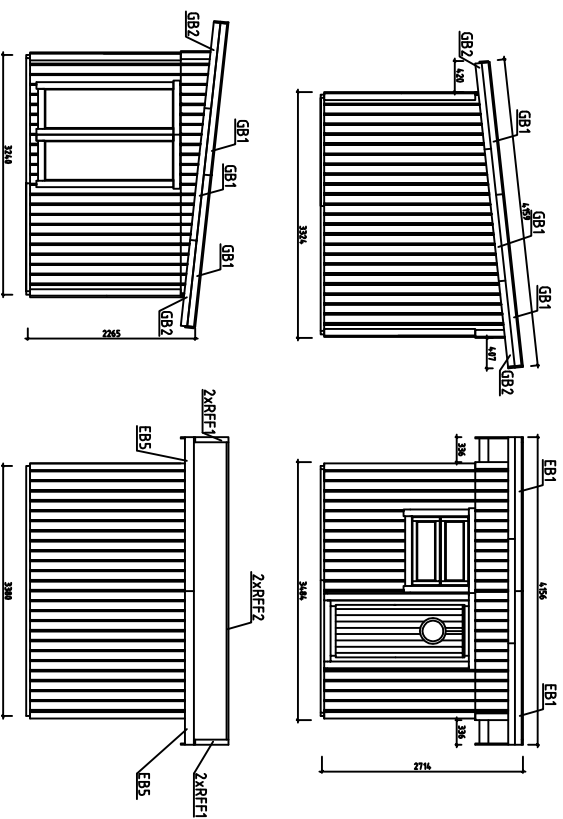
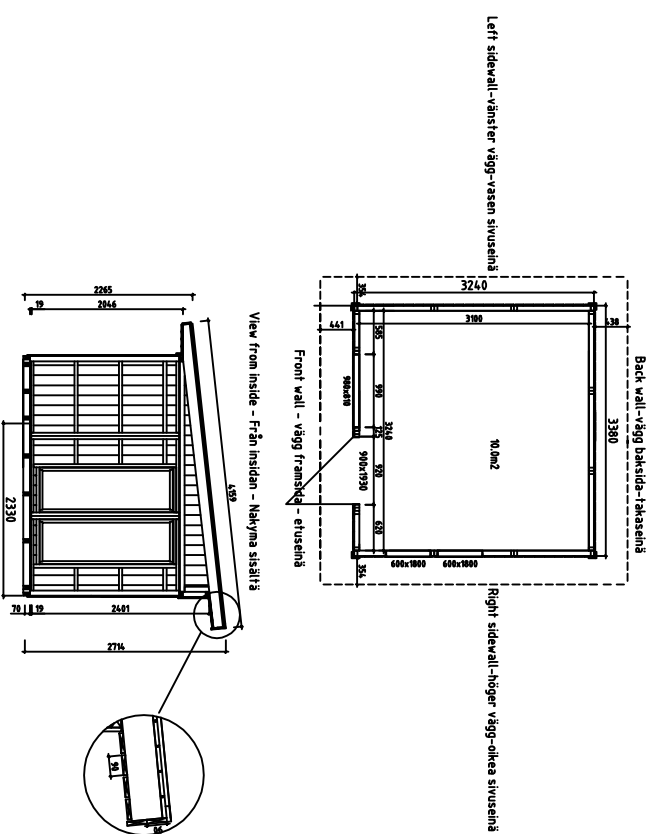

V 1.0

Date rev. Description

		House	Sheet 1
		Friggebod Christel	Scale 1:100
Drawing		Material	Date 27.01.2021
Drawer	K.K.	File	Friggebod Christel.dwg

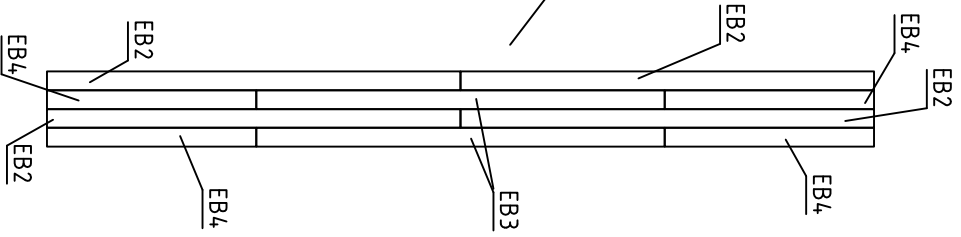
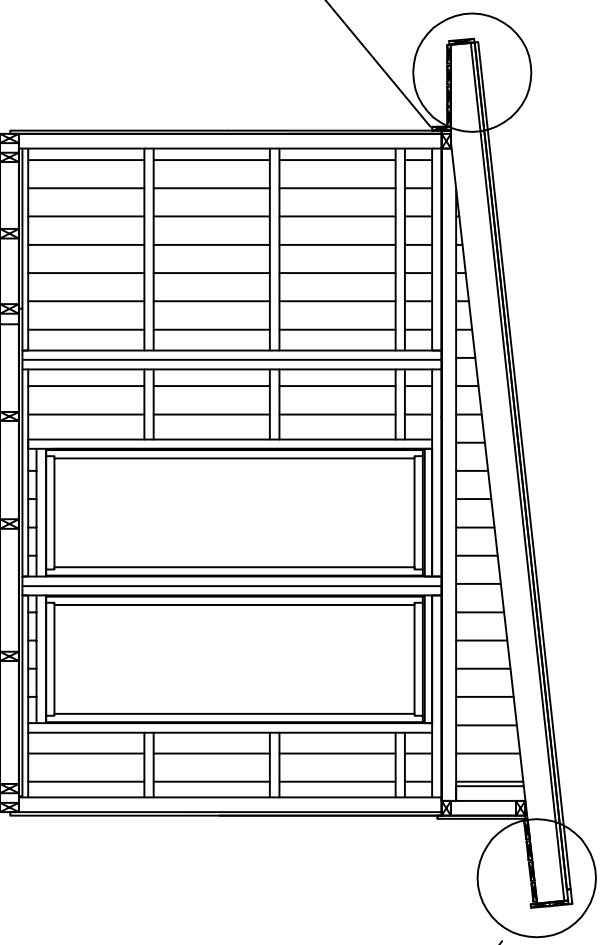
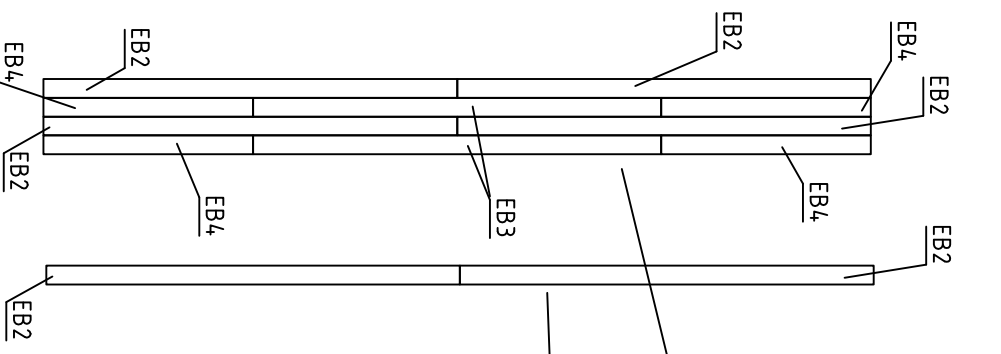

Date rev. Description

House	Friggebod Christel	Sheet	1A
Drawing	Eave boards view	Scale	1:35
Material		Date	27.01.2021
Drawer	K.K.	File	Friggebod Christel.dwg

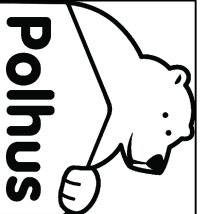

GABLE BOARD CONNECTING BOARD 18x70
 KAAPELLILAUTA YHDISTAMISLAUTA GCB
 BRÄDE FÖR FIXERA VINDBRÄDE

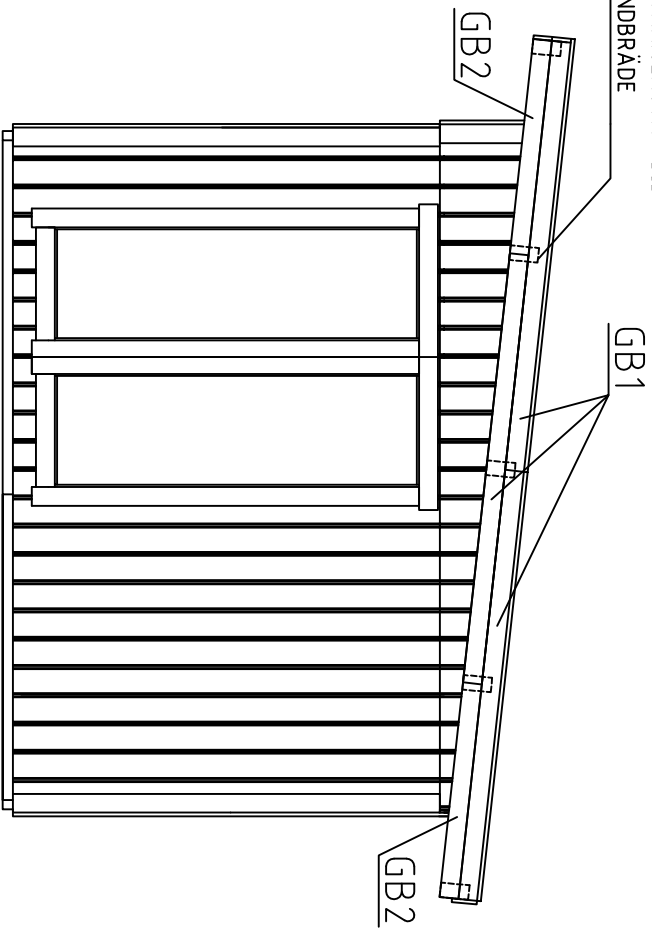

ROOF FELT FILLET 19x35
 KATON PÄÄTYLAUTA RFF
 TAKBRÄDE FÖR VINDBRÄDE

Gable slat 30x40
 Vindlist GS
 Kaapelitista GS

GABLE BOARD 19x90
 KAAPELLILAUTA GB
 VINDBRÄDE

GABLE BOARD CONNECTING BOARD 19x70
 KAAPELLILAUTA YHDISTAMISLAUTA GCB
 BRÄDE FÖR FIXERA VINDBRÄDE

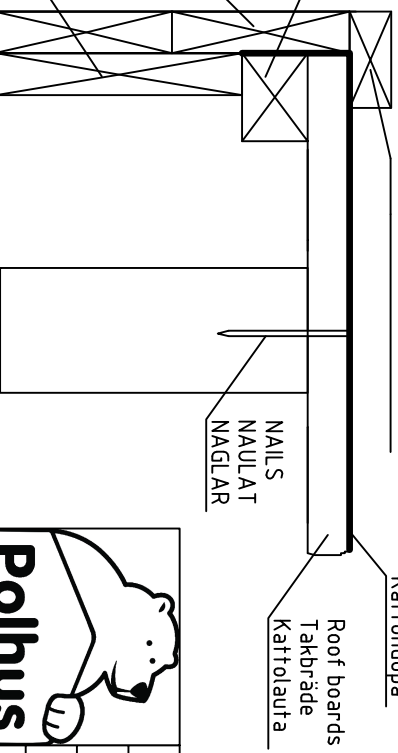

Date rev. Description

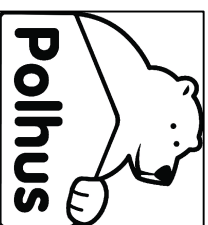

House	Friggebod Christel	Sheet	1B
Drawing	Gable boards view	Scale	1:35
Material		Date	27.01.2021
Drawer	K.K.	File	Friggebod Christel.dwg

GABLE BOARD CONNECTING BOARD 19x70
KAAPELLAUTA YHDISTAMISLAUTA GCB
BRÄDE FÖR FIXERA VINDBRÄDE

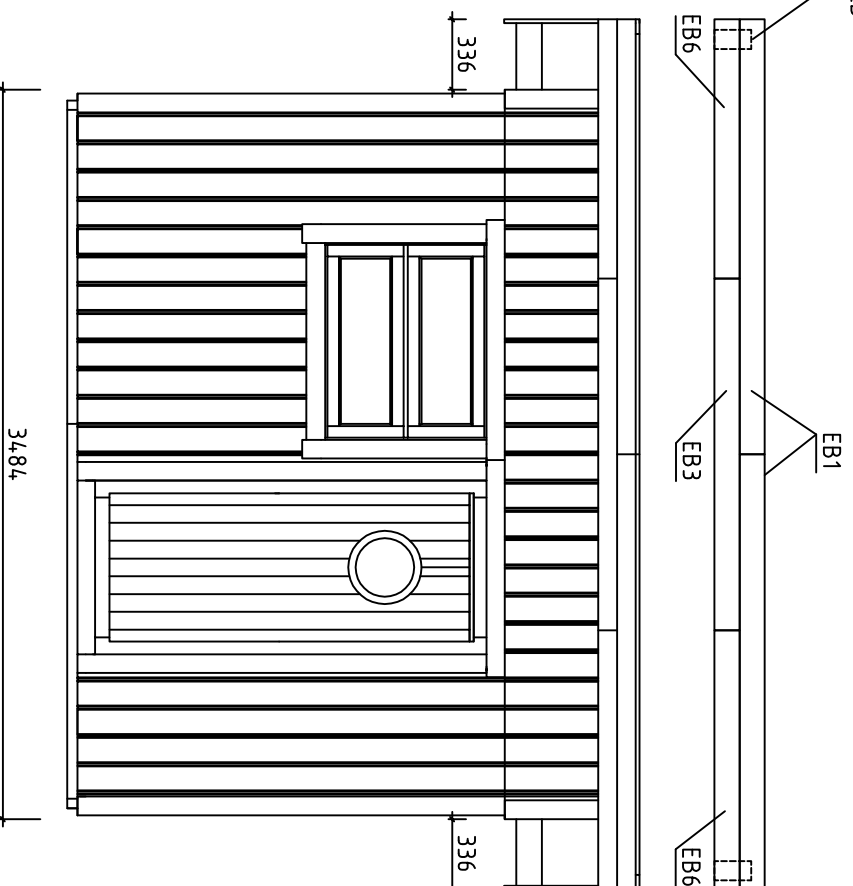

Date rev. Description

 Polhus	House	Friggebod Christel	Sheet	1C
	Drawing	Eave boards view	Scale	1:35
	Material		Date	27.01.2021
Drawer	K.K.	File	Friggebod Christel.dwg	

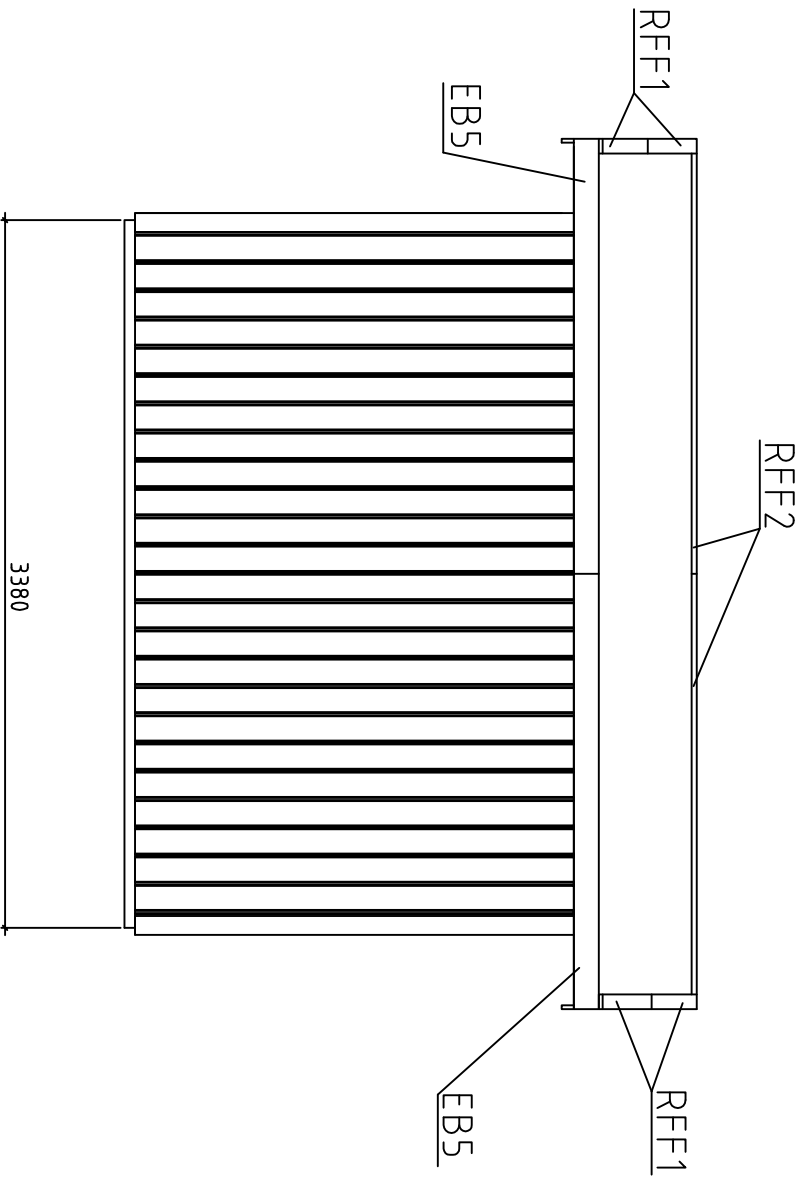

Date rev. Description

 Polhus		House	Friggebod Christel	Sheet	1D
Drawing	Eave boards view	Scale	1:35	Date	27.01.2021
Drawer	K.K.	File	Friggebod Christel.dwg		

Overview description of the manual - Översikts beskrivning för monteringen - Kokoonpano - ohjeiden kuvaminen

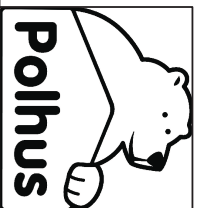
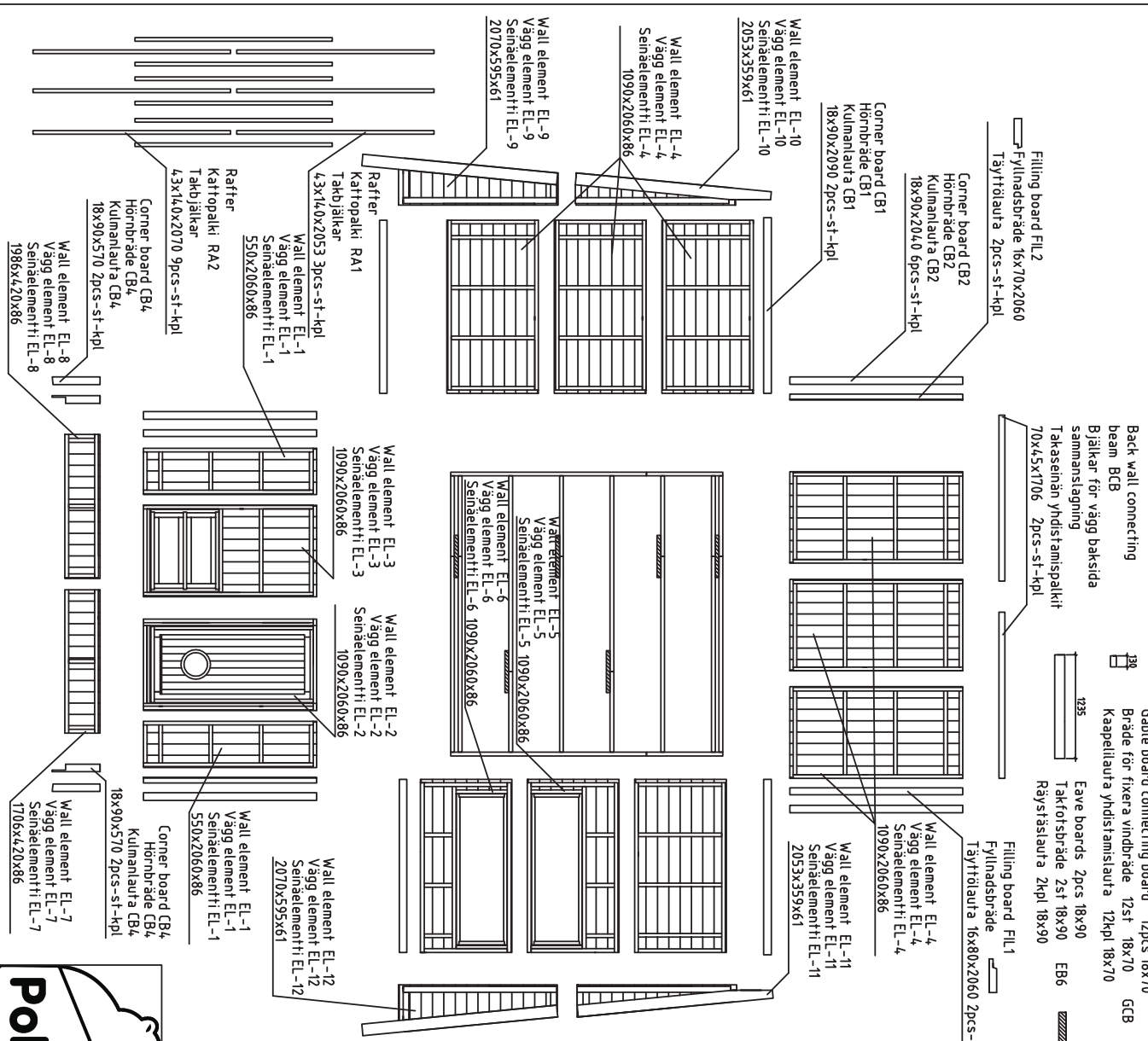

House	Friggebod Christel	Sheet	2
Drawing		Scale	1:35
Material		Date	13.01.2021
Drawer	K.K.	File	Friggebod Christel.dwg

Material	Quantity	Description	Code	Notes
Roofboard	38pcs (18x114) or 50pcs (18x88)	R1		
Takbräde	38st (18x114) och 50st (18x88)			
Katrolautta	38kpl (18x114) tai 50kpl (18x88)			
Roofboard	18pcs (18x114) or 24pcs (18x88)	R2		
Takbräde	18st (18x114) och 24st (18x88)			
Katrolautta	18kpl (18x114) tai 24kpl (18x88)			
Roofboard	36pcs (18x114) or 46pcs (18x88)	R3		
Takbräde	36st (18x114) och 46st (18x88)			
Katrolautta	36kpl (18x114) tai 46kpl (18x88)			
Floorboard	58pcs (18x114) or 76pcs (18x88)	F1		
Golvbräde	58st (18x114) och 76st (18x88)			
Lattilautta	58kpl (18x114) tai 76kpl (18x88)			
Floorboard	59pcs (18x114) or 76pcs (18x88)	F2		
Golvbräde	59st (18x114) och 76st (18x88)			
Lattilautta	58kpl (18x114) tai 76kpl (18x88)			
Floor fillet	7pcs 18x35	FF		
Golvilist	7st 18x35			
Lattilist	7kpl 18x35			
Gable board	6pcs 18x90	GB1		
Vindbräde	6st 18x90			
Kaapellautta	6kpl 18x90			
Gable board	4pcs 18x90	GB2		
Vindbräde	4st 18x90			
Kaapellautta	4kpl 18x90			
Gable slat	4pcs 30x40	GS		
Vindilist	4st 30x40			
Kaapellist	4kpl 30x40			
Roof felt fillet	4pcs 18x70	RF1		
Takbräde för vindbräde	4st 18x70			
Katon päällylauta	4kpl 18x70			
Roof felt fillet	2pcs 18x70	RF2		
Takbräde för vindbräde	2st 18x70			
Katon päällylauta	2kpl 18x70			
Eave boards	2pcs 18x90	EB1		
Taktrofsträde	2st 18x90			
Rävstäläutä	2kpl 18x90			
Eave boards	10pcs 18x90	EB2		
Taktrofsträde	10st 18x90			
Rävstäläutä	10kpl 18x90			
Eave boards	5pcs 18x90	EB3		
Taktrofsträde	5st 18x90			
Rävstäläutä	5kpl 18x90			
Eave boards	8pcs 18x90	EB4		
Taktrofsträde	8st 18x90			
Rävstäläutä	8kpl 18x90			
Eave boards	2pcs 18x120	EB5		
Taktrofsträde	2st 18x120			
Rävstäläutä	2kpl 18x120			

Installation of floorbeams and floorboards - monteringen av golvbjälkar samt golvbrädor - lattiapalkkien ja lattialautojen asennus

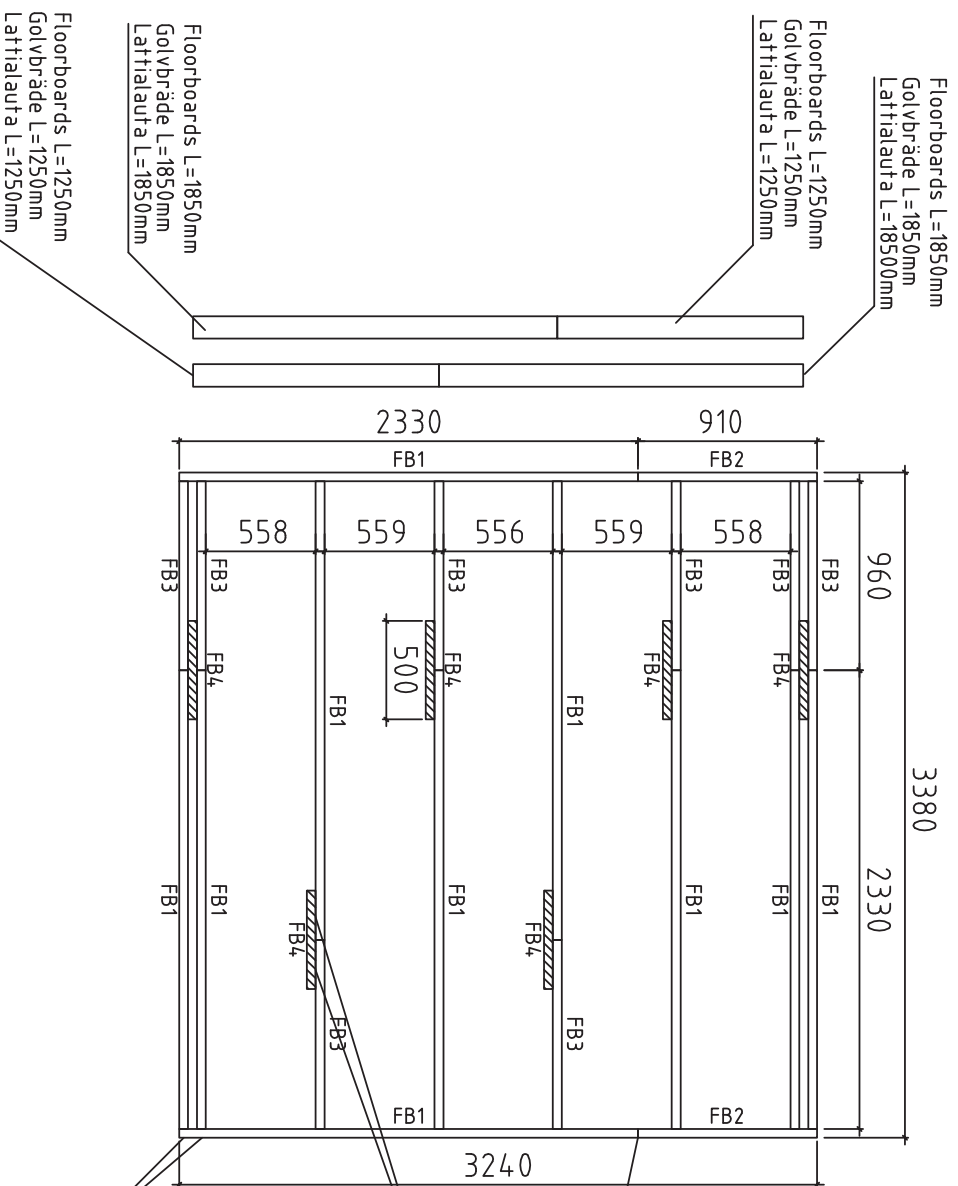

Connect with metal plate 60x160+screws 4,5x4,5 8pcs
 Skarvas med metall platta 60x160+skruvar 4,5x4,5 8st
 Liitetään metallilevyllä 60x160+ruuvit 4,5x4,5 8kpl

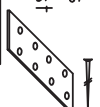

Connect with screws 4,5x70
 Skruvas samman med skruvar 4,5x70
 Kiinnitetään ruuveilla 4,5x70

Connect with screws 4,5x70
 Skruvas samman med skruvar 4,5x70
 Kiinnitetään ruuveilla 4,5x70

- NB!!! Change the floorboard positions after every row
- NB!!! Skarva golvräderna olika efter varje rad
- NB!!! Muuta lattialautojen sijaintia jokaisen rivin jälkeen

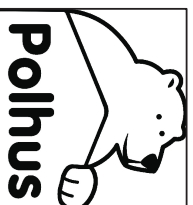

Date	rev.	Description	Sheet
		House Friggebod Christel	3
		Drawing Floorbeams-lattiapalkit-golvbjälkar	Scale 1:35
		Material 4,5x90	Date 13.01.2021
		Drawer K.K.	File Friggebod Christel.dwg

Installation of wall element EL-1 - monterering av vägg element EL-1 - seinäelementin EL-1 asennus
(Front wall - vägg framsida - etuseinä)

View from inside - Från insidan - Näkymä sisältä

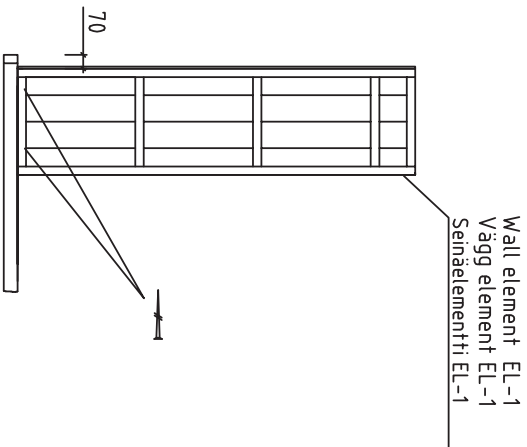

Fix wall element EL-1 with screws
4.5x70 into floorbeam
Fixera vägg element EL-1 med skruvar
4.5x70 i golvbjälke
Kiinnitä seinäelementti EL-1 ruuveilla
4.5x70 lattipalkkin

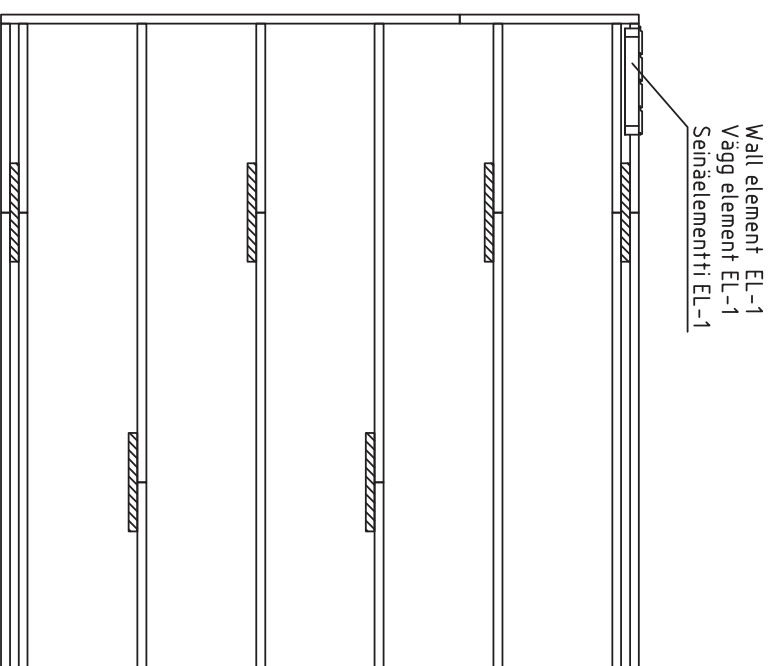

Date rev. Description

 Polhus		House	Friggebod Christel	Sheet	4
Drawer	K.K.	Drawing		Scale	1:35
		Material		Date	13.01.2021
		File	Friggebod Christel.dwg		

Installation of wall element EL-2 and EL-1 – montering av vägg element EL-2 och EL-1 – seinäelementin EL-2 ja EL-1 asennus
(Front wall – vägg framsida – etuseinä)

View from inside – Från insidan – Nakyma sisältä

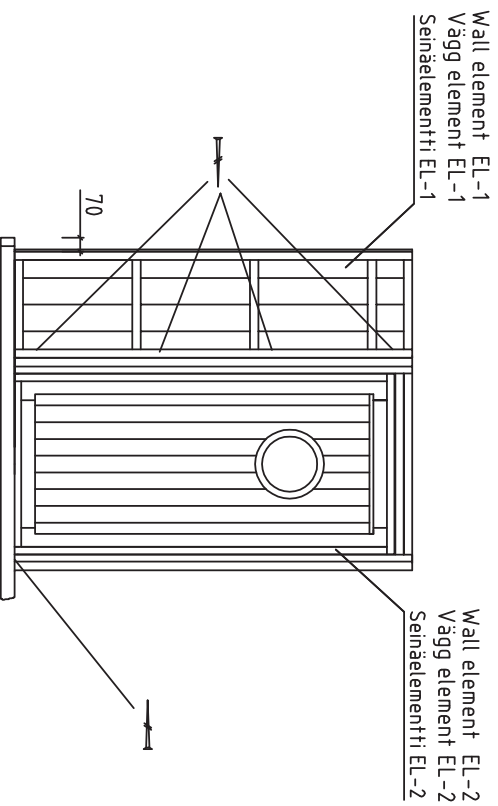

Fix wall element EL-2 with screws

4.5x70 into floorbeam

Fixera vägg element EL-2 med skruvar

4.5x70 i golvbjälke

Kiinnitä seinäelementti EL-2 ruuveilla

4.5x70 lattiapalkkin

Fix wall elements EL-2 and EL-1 with screws

4.5x70 together

Fixera vägg element EL-2 och EL-1 med skruvar

4.5x70 tillsammans

Kiinnitä seinäelementit EL-2 ja EL-1

yhteen ruuveilla 4.5x70

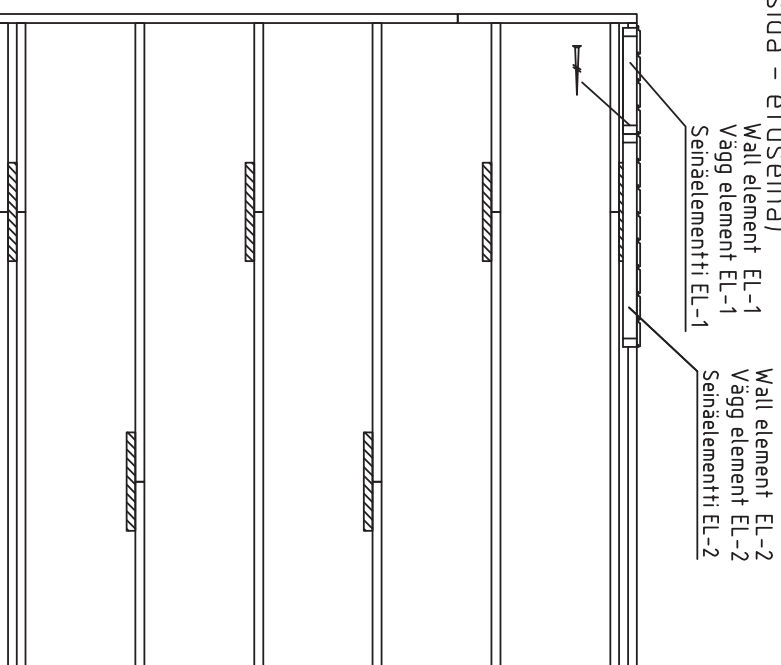

Date rev. Description

		House	Friggebod Christel	Sheet	5
		Drawing		Scale	1:35
Material		Date	13.01.2021		
Drawer	K.K.	File	Friggebod Christel.dwg		

Installation of wall element EL-3 and EL-2 – monterering av vägg element EL-3 och EL-2 –seinäelementin EL-3 ja EL-2 asennus
(Front wall – vägg framsida – etuseinä)

View from inside – Från insidan – Näkymä sisältä

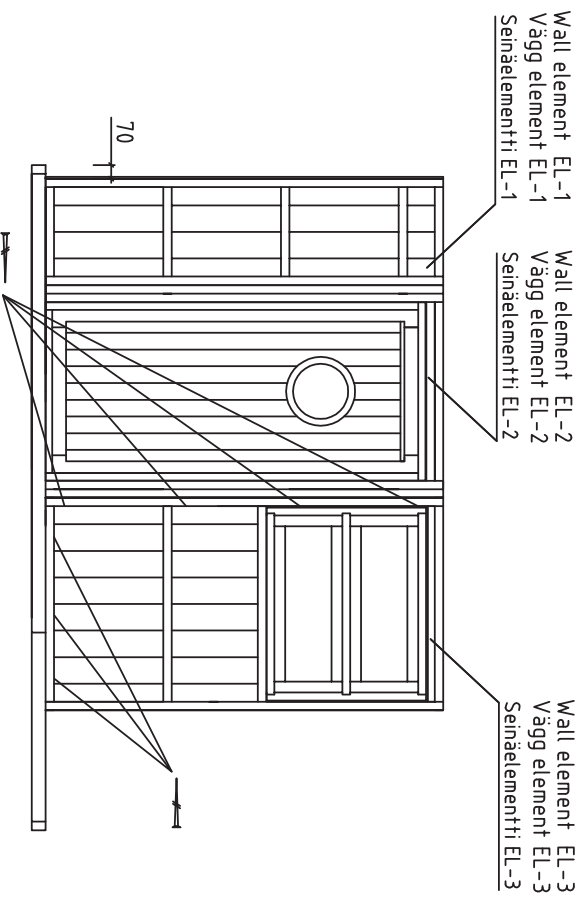

Fix wall element EL-3 with screws
4.5x70 into floorbeam

Fixera vägg element EL-3 med skruvar
4.5x70 i golvbjälke

Kiinnitä seinäelementti EL-3 ruuveilla
4.5x70 lattiapalkkin

Fix wall elements EL-3 and EL-2 with screws
4.5x70 together

Fixera vägg element EL-3 och EL-2 med skruvar
4.5x70 tillsammans

Kiinnitä seinäelementit EL-3 ja EL-2
yhteen ruuveilla 4.5x70

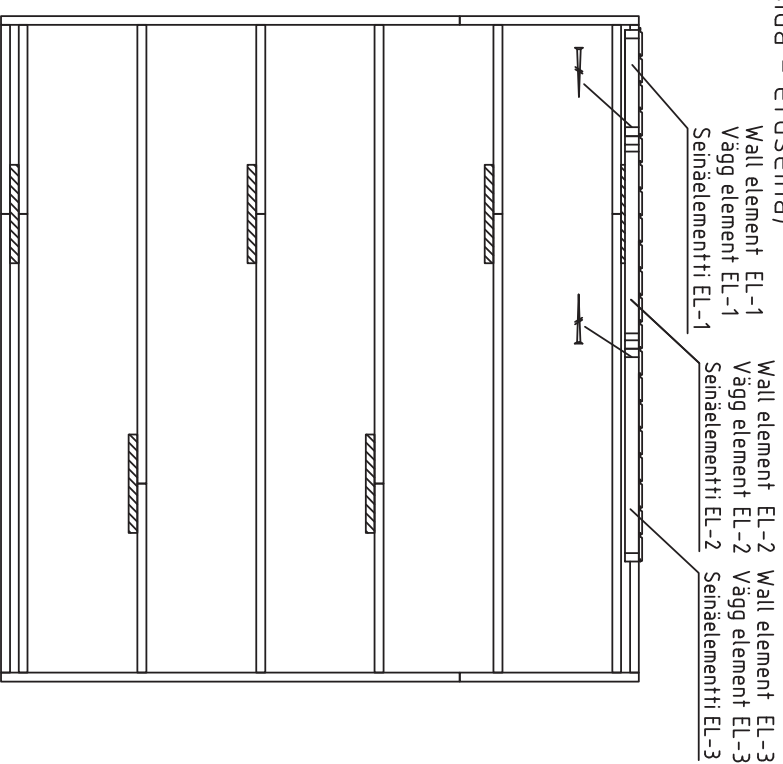

Date rev. Description

		House	Friggebod Christel	Sheet	7
Drawer	K.K.	Drawing		Scale	1:35
		Material		Date	13.01.2021
		File	Friggebod Christel.dwg		

Installation of wall element EL-3 and EL-1 – montering av vägg element EL-3 och EL-1 –seinäelementin EL-3 ja EL-1 asennus
(Front wall – vägg framsida – etuseinä)

View from inside – Från insidan – Näkymä sisältä

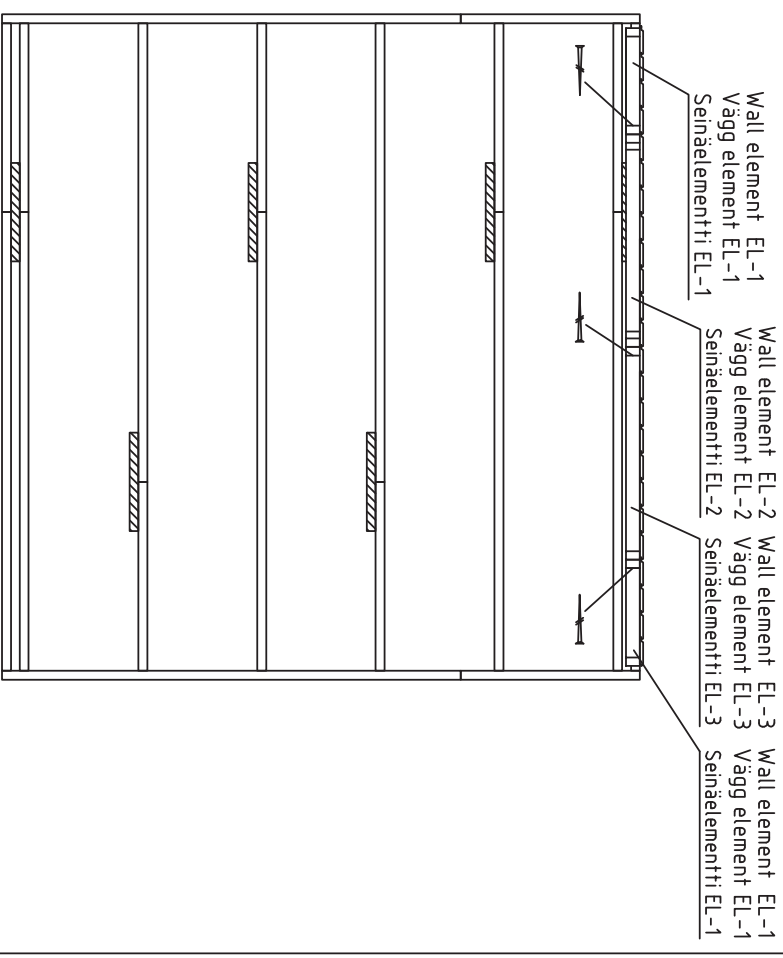
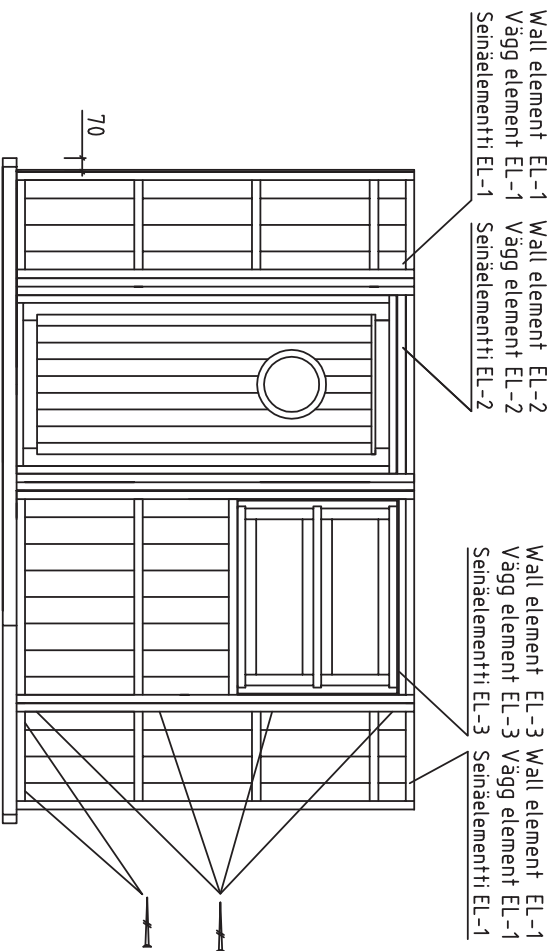

Fix wall element EL-1 with screws

4.5x70 into floorbeam

Fixera vägg element EL-1 med skruvar

4.5x70 i golvbjälke

Kiinnitä seinäelementti EL-1 ruuvella

4.5x70 lattiapalkkin

Fix wall elements EL-1 and EL-3 with screws

4.5x70 together

Fixera vägg element EL-1 och EL-3 med skruvar

4.5x70 tillsammans

Kiinnitä seinäelementit EL-1 ja EL-3

yhteen ruuvella 4.5x70

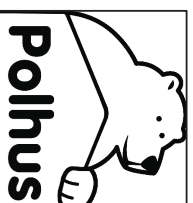

Date	rev.	Description	Sheet
		House Friggebod Christel	8
		Drawing	Scale 1:35
		Material	Date 13.01.2021
Drawer	K.K.	File	Friggebod Christel.dwg

Installation of left sidewall – montering av vänster sidovägg – vasen sivuseinä asennus

View from inside – Från insidan – Näkymä sisältä

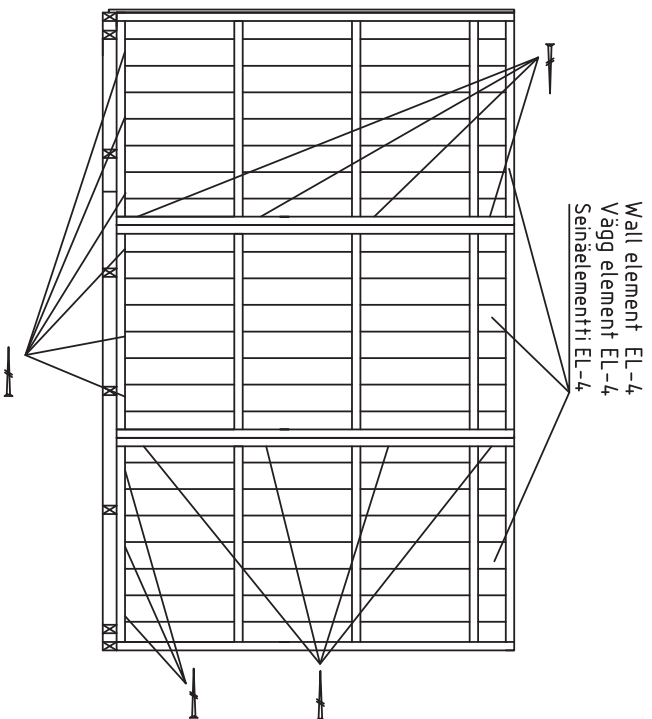

Fix wall element EL-4 (3pcs) with screws

4.5x70 into floorbeam

Fixera vägg element EL-4 (3st) med skruvar

4.5x70 i golvbjälke

Kiinnitä seinäelementti EL-4 (3kpl) ruuveilla

4.5x70 lattiapalkkin

Fix wall elements EL-1 and EL-4 with screws 4.5x70 together

Fixera vägg element EL-1 och EL-4 med skruvar 4.5x70 tillsammans

Kiinnitä seinäelementit EL-1 ja EL-4 yhteen ruuveilla 4.5x70

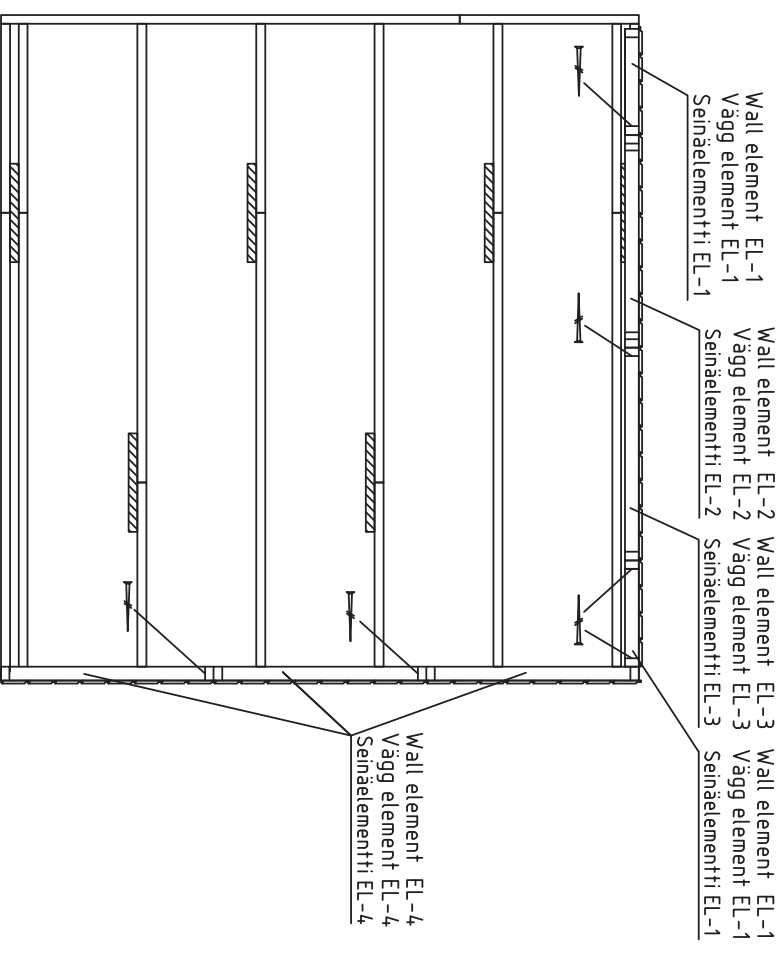

Date rev. Description

 Polhus	House	Friggebod Christel	Sheet	9
	Drawing		Scale	1:35
	Material		Date	13.01.2021
	Drawer	K.K.	File	Friggebod Christel.dwg

Installation of back wall – montering av vägg baksida – takaseinä asennus

View from inside – Från insidan – Nakyma sisältä

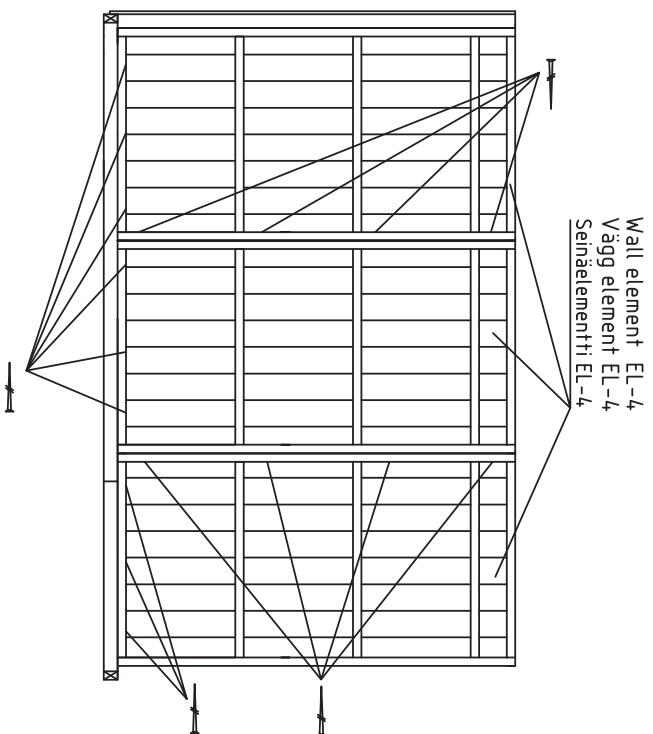

Fix wall element EL-4 (3pcs) with screws

4.5x70 into floorbeam

Fixera vägg element EL-4 (3st) med skruvar

4.5x70 i golvbjälke

Kiinnitä seinäelementti EL-4 (3kpl) ruuveilla

4.5x70 lattiapalkkin

Fix wall elements EL-4 with screws 4.5x70 together

Fixera vägg element EL-4 med skruvar 4.5x70 tillsammans

Kiinnitä seinäelementit EL-4 yhteen ruuveilla 4.5x70

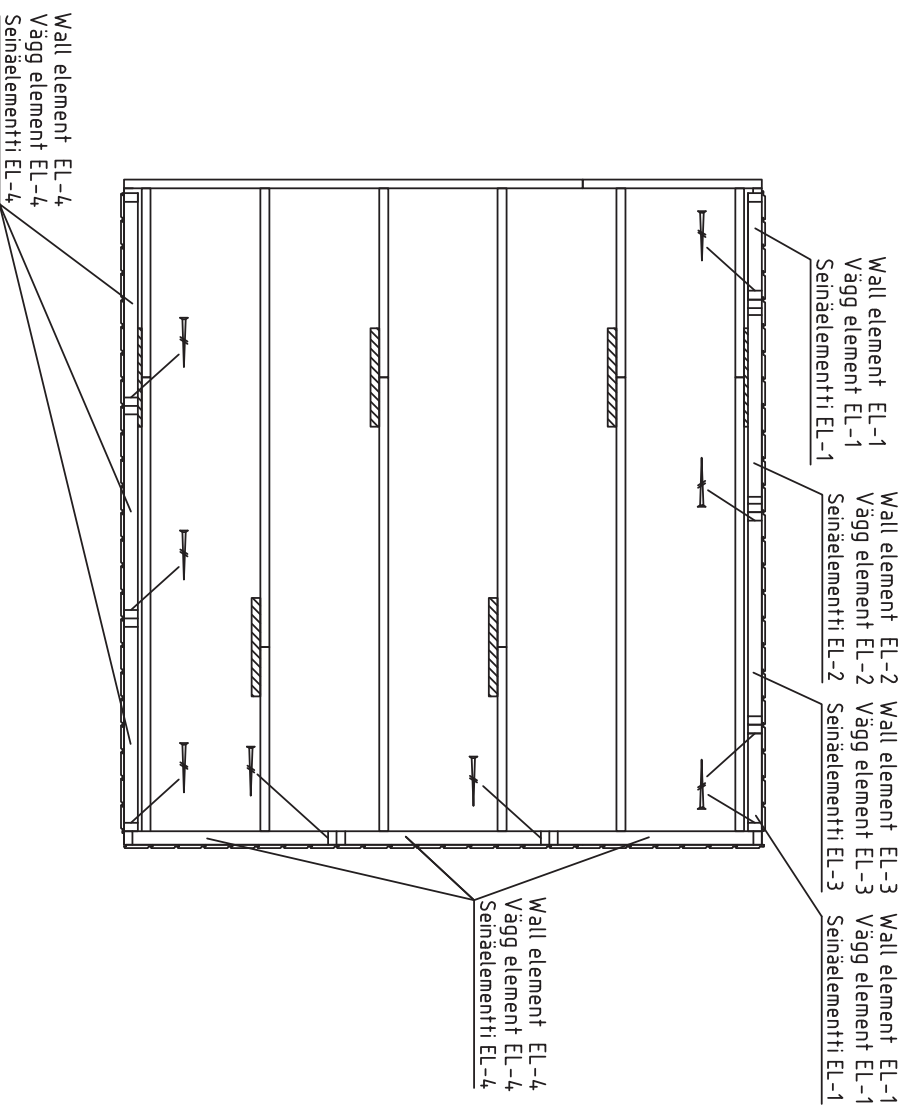

Wall element EL-4
Vägg element EL-4
Seinäelementti EL-4

Date rev. Description

	House	Friggebod Christel	Sheet	10
	Drawing		Scale	1:35
	Material		Date	13.01.2021
Drawer	K.K.	File	Friggebod Christel.dwg	

Installation of right sidewall – montering av höger sidovägg – oikea sivuseinä asennus

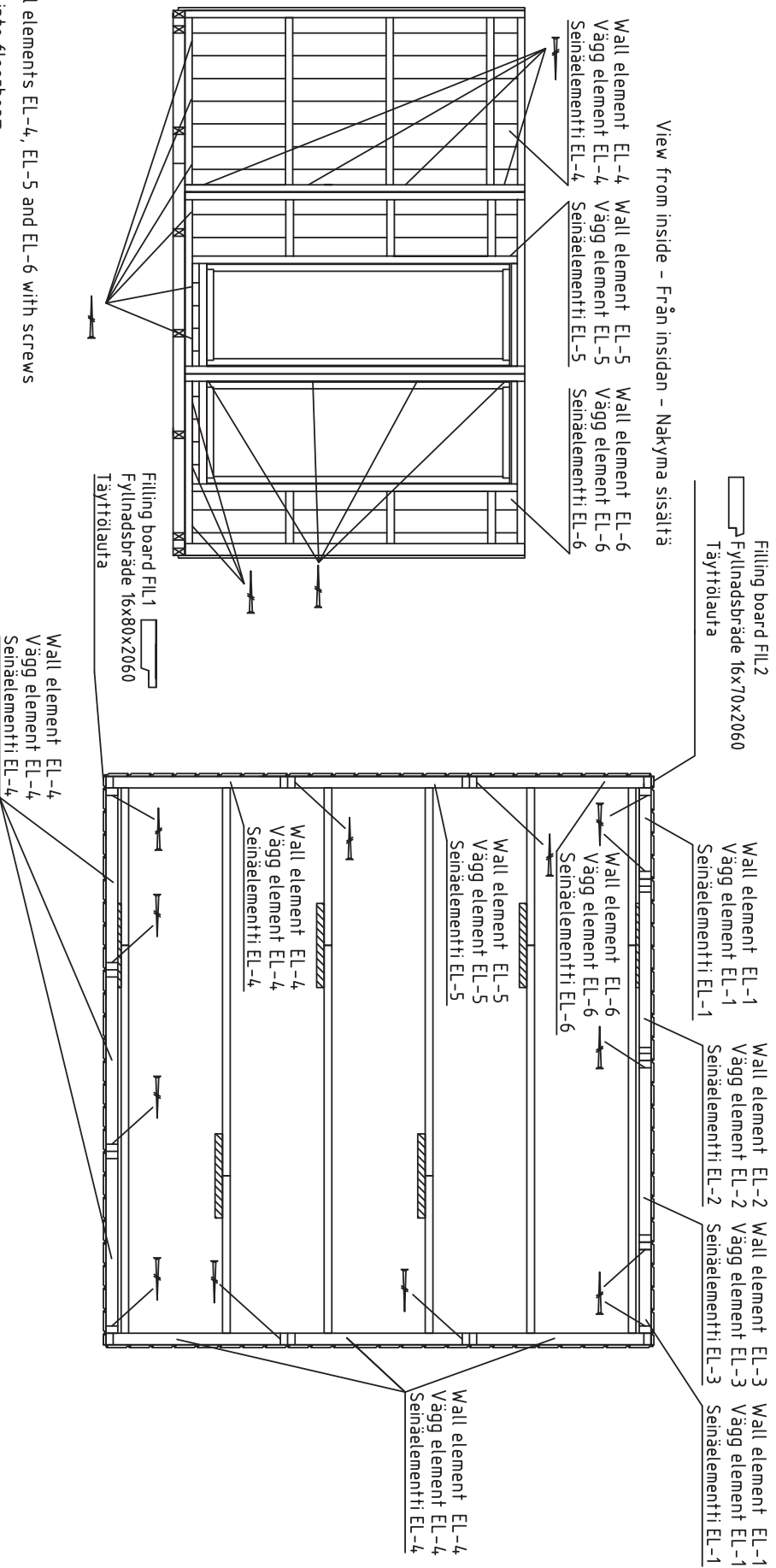

Fix wall elements EL-4, EL-5 and EL-6 with screws

4,5x70 into floorbeam

Fixera vägg element EL-4, EL-5 och EL-6 med skruvar

4,5x70 i golvbjälke

Kiinnitä seinäelementti EL-4, EL-5 ja EL-6 ruuveilla

4,5x70 lattiapalkkin

Fix wall elements EL-1; EL-4; EL-5 and EL-6 with screws 4,5x70 together

Fixera vägg element EL-1; EL-4; EL-5 och EL-6 med skruvar 4,5x70 tillsammans

Kiinnitä seinäelementit EL-1; EL-4; EL-5 ja EL-6 yhteen ruuveilla 4,5x70

Täyttölauta

Date rev. Description

House Friggebod Christel Sheet 11

Drawing Material Scale 1:35

Date 13.01.2021

Drawer K.K. File Friggebod Christel.dwg

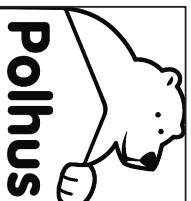

Installation of back wall connecting beams - montering av bjälkar för vägg baksida sammanslagning - takaseinän yhdistämispalkit asennus

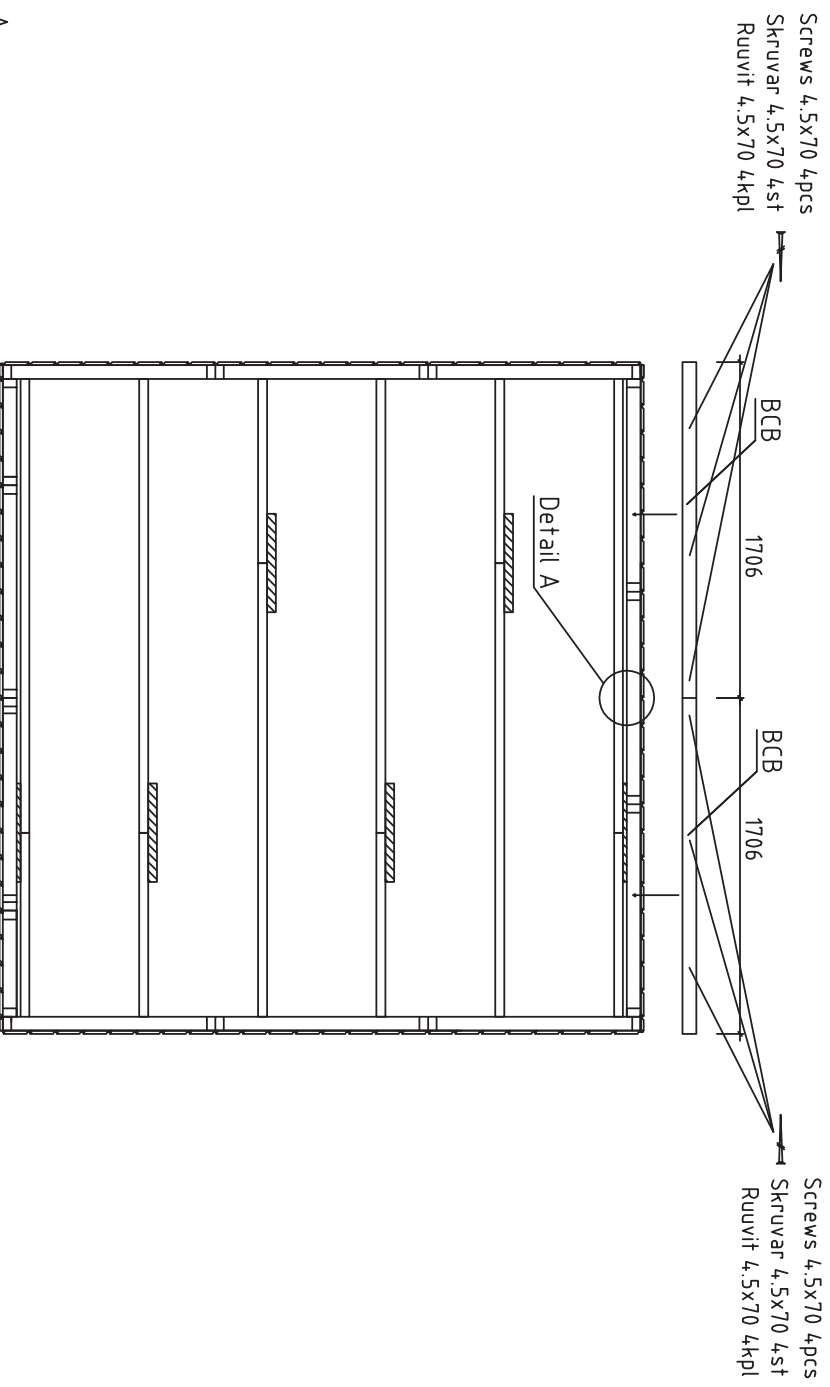

Screws 4.5x70
Skruvar 4.5x70
Ruuvit 4.5x70

Detail A

BCB

Back wall-vägg baksida-takaseinä

Date rev. Description

House Friggebod Christel Sheet 12

Drawing Scale 1:35

Material Date 13.01.2021

Drawer K.K. File Friggebod Christel.dwg

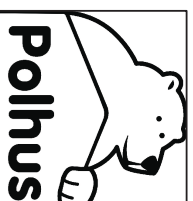

Installation of wall element EL-7 and EL-8 - montering av vägg element EL-7 och EL-8 - seinäelementin EL-7 ja EL-8 asennus
(Front wall - vägg framsida - etuseinä)

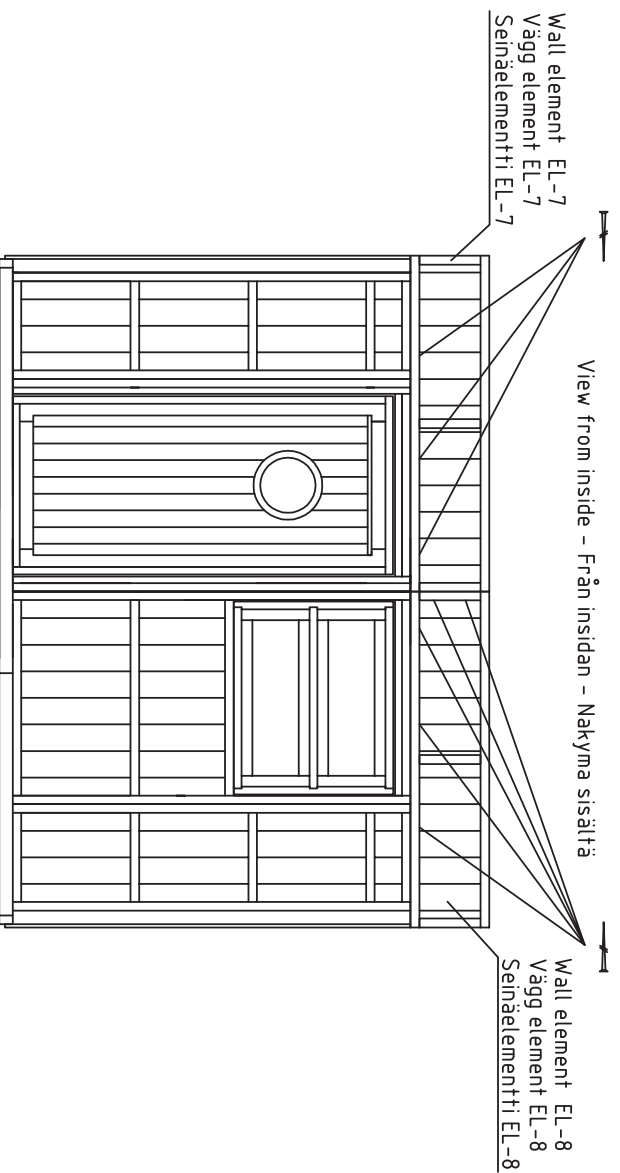

Fix wall element EL-7 with front wall elements with screws 4.5x70 together

Fixera vägg element EL-7 med elementat vägg framsida med skruvar 4.5x70 tillsammans

Kiinnitä seinäelementti EL-7 yhteen etuseinän elementit ruuveilla 4.5x70

Fix wall element EL-8 to front wall elements with screws 4.5x70 together

Fixera vägg element EL-8 med elementat vägg framsida med skruvar 4.5x70 tillsammans

Kiinnitä seinäelementti EL-8 yhteen etuseinä elementit ruuveilla 4.5x70

Fix wall elements EL-7 and EL-8 with screws 4.5x70 together

Fixera vägg element EL-7 och EL-8 med skruvar 4.5x70 tillsammans

Kiinnitä seinäelementit EL-7 ja EL-8 yhteen ruuveilla 4.5x70

 Polhus			
House	Friggebod Christel	Sheet	13
Drawing		Scale	1:35
Material		Date	13.01.2021
Drawer	K.K.	File	Friggebod Christel.dwg

Installation of wall element EL-9 and EL-10 – monterering av vägg element EL-9 och EL-10 –seinäelementin EL-9 ja EL-10 asennus
(Left sidewall – vänster sidovägg – vasen sivuseinä)

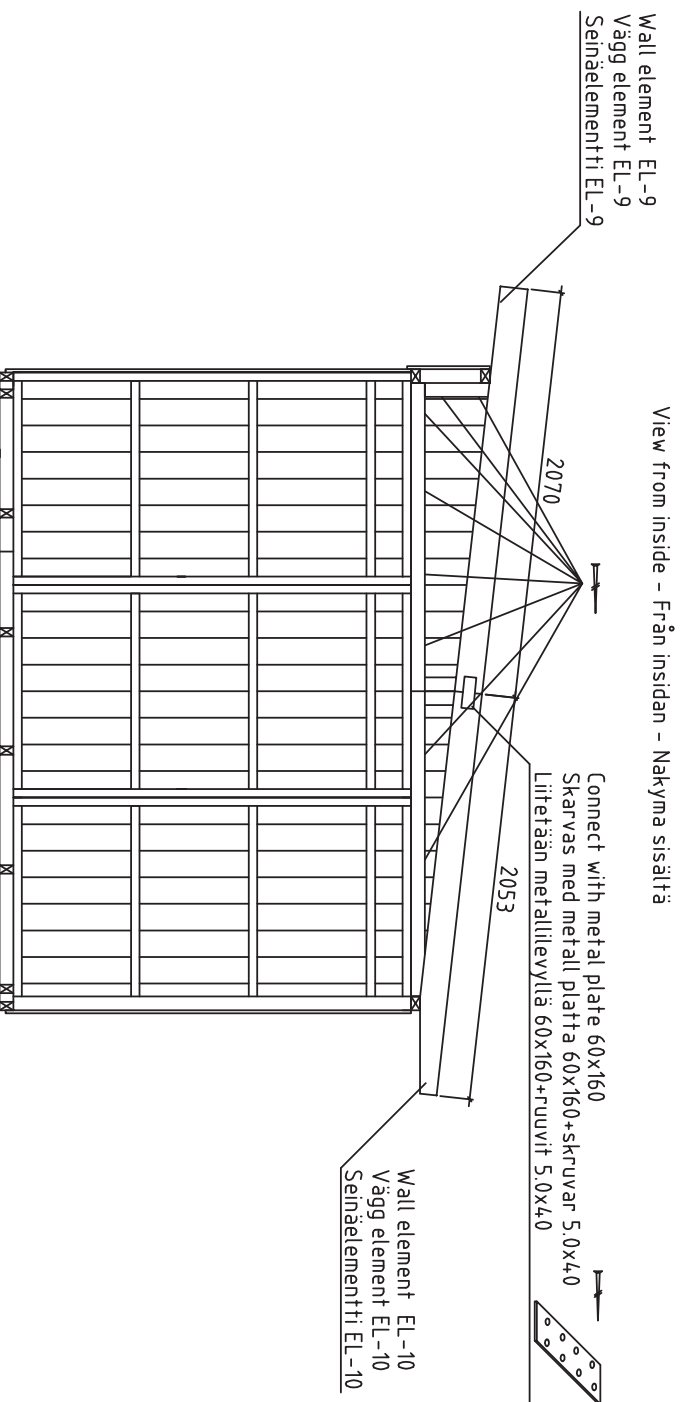

Fix wall element EL-9 with left sidewall elements with screws 5.0x120 together

Fixera vägg element EL-9 med elementat vänster sidovägg med skruvar 5.0x120 tillsammans

Kiinnitä seinäelementti EL-9 yhteen vasen sivuseinä elementit ruuveilla 5.0x120

Fix wall elements EL-9 and EL-8 with screws 5.0x120 together

Fixera vägg element EL-9 och EL-8 med skruvar 5.0x120 tillsammans

Kiinnitä seinäelementit EL-9 ja EL-8 yhteen ruuveilla 5.0x120

Fix wall element EL-10 with left sidewall elements with screws 5.0x120 together

Fixera vägg element EL-10 med elementat vänster sidovägg med skruvar 5.0x120 tillsammans

Kiinnitä seinäelementti EL-10 yhteen vasen sivuseinä elementit ruuveilla 5.0x120

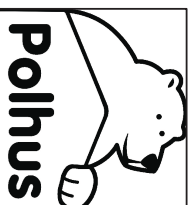

Date	rev.	Description	Sheet
		House Friggebod Christel	14
		Drawing	Scale 1:35
		Material	Date 13.01.2021
Drawer	K.K.	File	Friggebod Christel.dwg

Installation of wall element EL-11 and EL-12 – montering av vägg element EL-11 och EL-12 – seinäelementin EL-11 ja EL-12 asennus
(Right sidewall – höger sidovägg – oikea sivuseinä)

View from inside – Från insidan – Näkymä sisältä

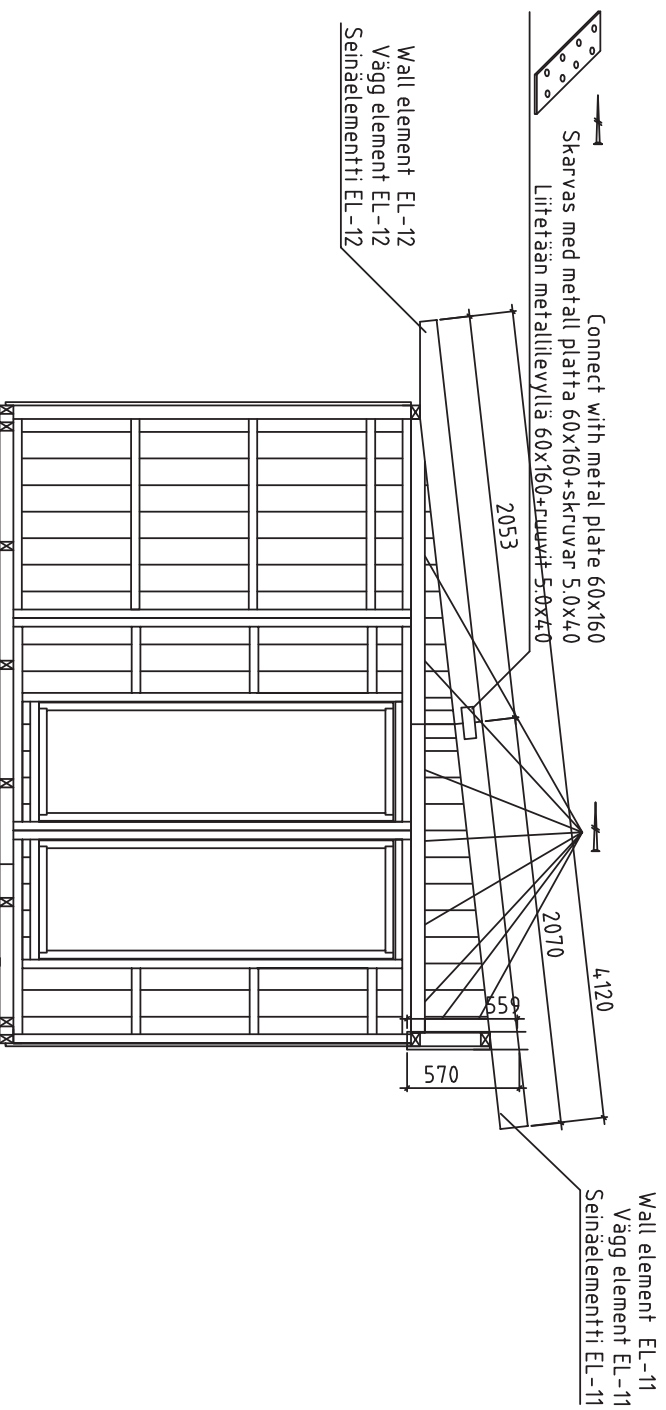

Fix wall element EL-11 with right sidewall elements with screws 5.0x120 together

Fixera vägg element EL-11 med elementat höger sidovägg med skruvar 5.0x120 tillsammans

Kiinnitä seinäelementti EL-11 yhteen oikea sivuseinä elementit ruuveilla 5.0x120

Fix wall element EL-12 with right sidewall elements with screws 5.0x120 together

Fixera vägg element EL-12 med elementat höger sidovägg med skruvar 5.0x120 tillsammans

Kiinnitä seinäelementti EL-12 yhteen oikea sivuseinä elementit ruuveilla 5.0x120

Fix wall elements EL-12 and EL-7 with screws 5.0x120 together

Fixera vägg element EL-12 och EL-7 med skruvar 5.0x120 tillsammans

Kiinnitä seinäelementit EL-12 ja EL-7 yhteen ruuveilla 5.0x120

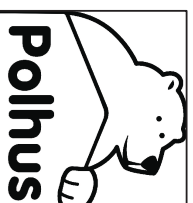

Date	rev.	Description	Sheet
		House Friggebod Christel	15
		Drawing	Scale 1:35
		Material	Date 13.01.2021
Drawer	K.K.	File	Friggebod Christel.dwg

Roofbeams connecting-montering av takbjälkar-kattopalki yhdistamine

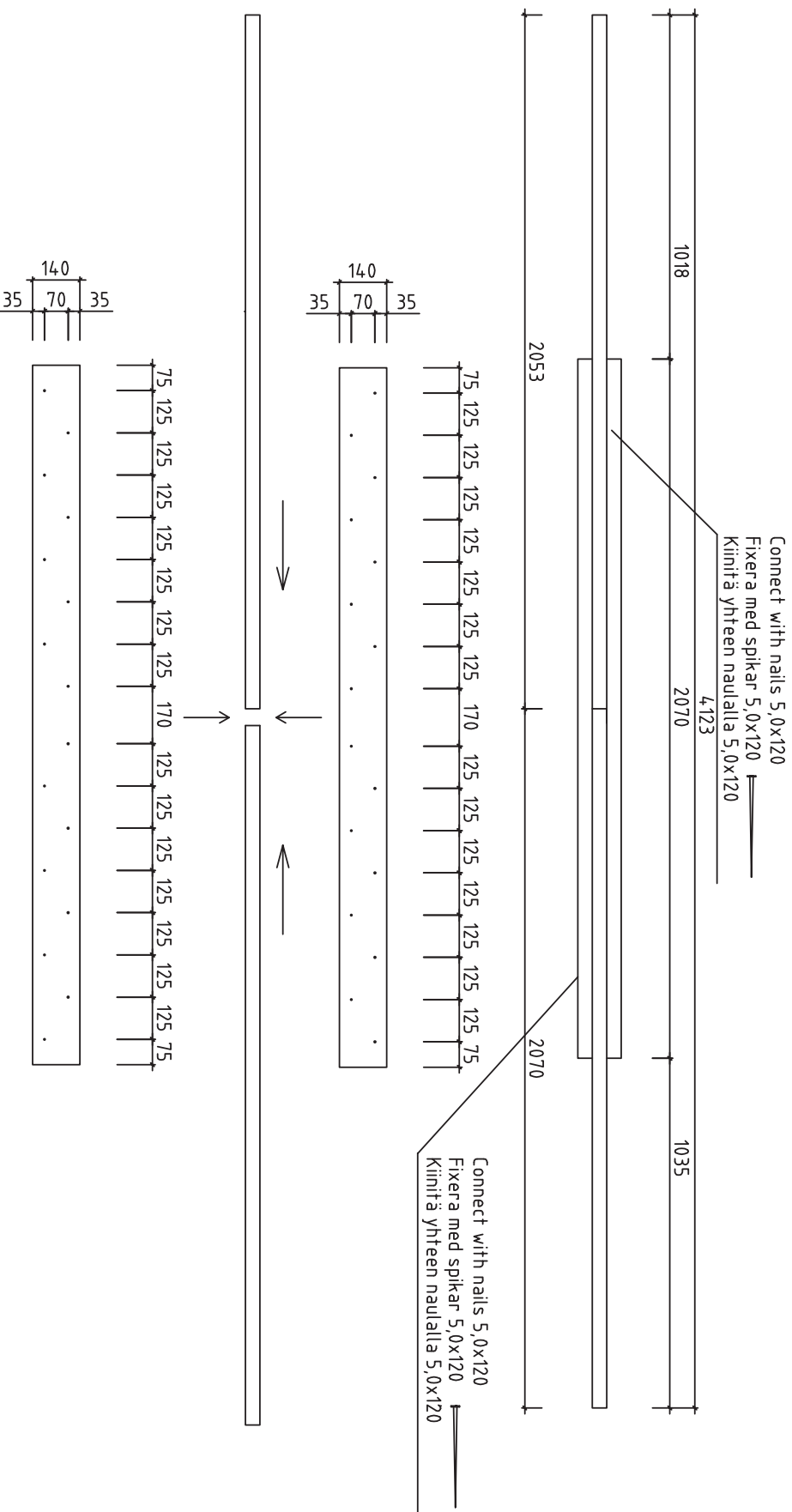

NB!!! Bore holes \varnothing 5mm before so that on one side and on other side holes dosen't match

NB!!! Skruva från båda sidorna men inte så att dessa möter varandra

Date rev. Description

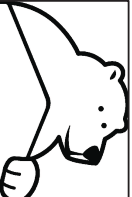
 Polhus	House	Friggebod Christel	Sheet	16
	Drawing	Roofbeams connecting-montering av takbjälkar	Scale	1:35
	Material		Date	13.01.2021
Drawer	K.K.	File	Friggebod Christel.dwg	

Ferm install-installera takläggning-kattoparru asennus

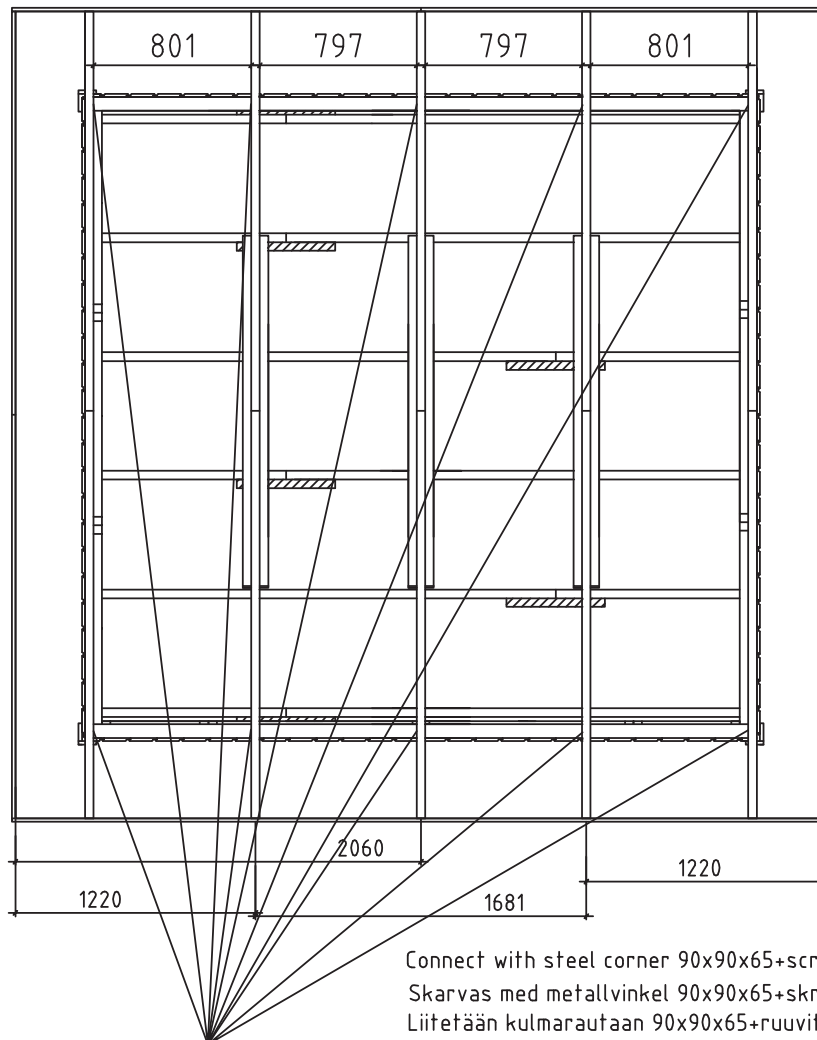
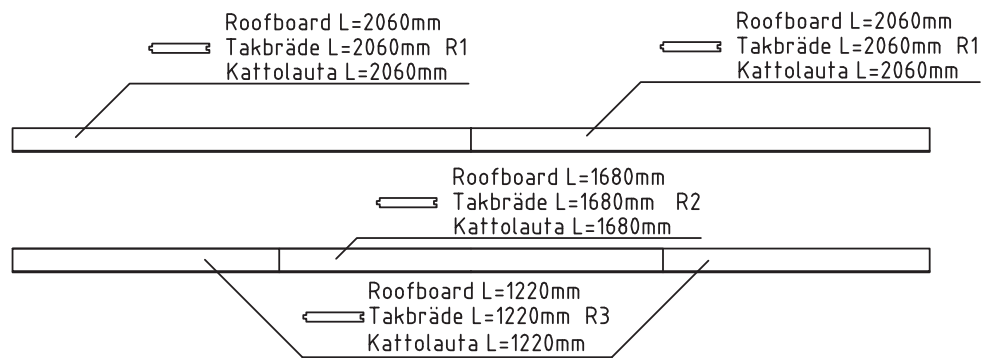

Connect with steel corner 90x90x65+screws 4.5x45 10pcs
 Skarvas med metallvinkel 90x90x65+skruvar 4.5x45 10st
 Liitetään kulmarautaan 90x90x65+ruuvit 4.5x45 10kpl



NB!!! Change the roofboard positions after every row
 NB!!! Skarva tak brädorna olika efter varje rad
 NB!!! Muuta kattolautojen sijaintia jokaisen rivin jälkeen

Date rev. Description

	House	Friggebod Christel	Sheet	17
	Drawing		Scale	1:35
	Material		Date	13.01.2021
	Drawer	K.K.	File	Friggebod Christel.dwg

2 PAKKI L<2.35m

Wall element EL-7 1pc
Vägg element EL-7 1st
Seinäelementti EL-7 1kpl
1706x420x86

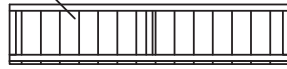

Wall element EL-8 1pc
Vägg element EL-8 1st
Seinäelementti EL-8 1kpl
1716x420x86

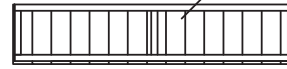

Wall element EL-1 2pcs
Vägg element EL-1 2st
Seinäelementti EL-1 2kpl
550x2060x86

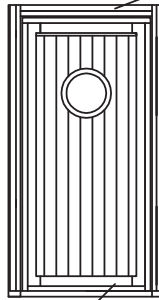
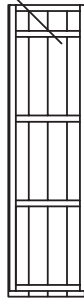

Wall element EL-3 1pc
Vägg element EL-3 1st
Seinäelementti EL-3 1kpl
1090x2060x86

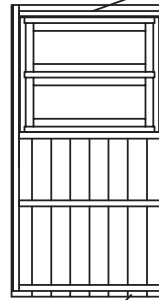

Wall element EL-4 7pcs
Vägg element EL-4 7st
Seinäelementti EL-4 7kpl
1090x2060x86

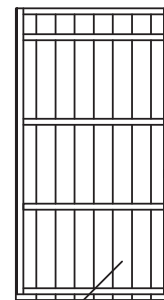

Wall element EL-2 1pc
Vägg element EL-2 1st
Seinäelementti EL-2 1kpl
1090x2060x86

Wall element EL-5 1pc
Vägg element EL-5 1st
Seinäelementti EL-5 1kpl
1090x2060x86

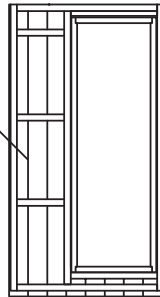

Wall element EL-6 1pc
Vägg element EL-6 1st
Seinäelementti EL-6 1kpl
1090x2060x86



Wall element EL-9 1pc
Vägg element EL-9 1st
Seinäelementti EL-9 1kpl
2070x595x61



Wall element EL-10 1pc
Vägg element EL-10 1st
Seinäelementti EL-10 1kpl
2053x359x61



Wall element EL-11 1pc
Vägg element EL-11 1st
Seinäelementti EL-11 1kpl
2053x359x61

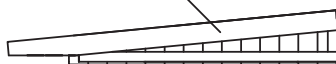









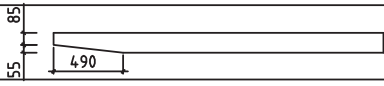
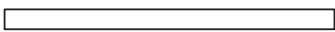
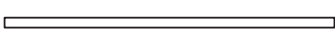
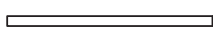
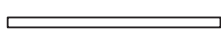















Wall element EL-12 1pc
Vägg element EL-12 1st
Seinäelementti EL-12 1kpl
2070x595x61

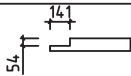

Polhus

2 PAKKI L<2.35m

Pos	Friggebod Christel	Nr. Pcs.	Profile (mm)	L (mm)
RA1	RAFTER - KATTOPALKI - TAKBJÄLKAR 	3	43x140	2053
RA2	RAFTER - KATTOPALKI - TAKBJÄLKAR 	9	43x140	2070
FB1	FLOORBEAM - LATTIAPALKI - GOLVBJÄLKAR 	10	45x90	2330
FB2	FLOORBEAM - LATTIAPALKI - GOLVBJÄLKAR 	2	45x90	910
FB3	FLOORBEAM - LATTIAPALKI - GOLVBJÄLKAR 	8	45x90	960
FB4	FLOORBEAM CONNECTING BEAM - LATTIAPALKI YHDISTAMISPALKIT BRÄDE FÖR GOLVBJÄLKAR SAMMANSLAGNING 	6	45x90	500
BCB	BACK WALL CONNECTING BEAM - TAKASEINÄ YHDISTAMISPALKIT BJÄLKAR FÖR SIDOVÄGG SAMMANSLAGNING 	2	45x70	1706
F1	FLOORBOARD - LATTIALAUTA - GOLVBRÄDE  88mm or-tai-eller 114mm	58+1 76+1	18x114 18x88	1850
F2	FLOORBOARD - LATTIALAUTA - GOLVBRÄDE  88mm or-tai-eller 114mm	58+1 76+1	18x114 18x88	1250
R1	ROOFBOARD - KATTOLAUTA - TAKBRÄDE  88mm or-tai-eller 114mm	38+1 50+1	18x114 18x88	2060
R2	ROOFBOARD - KATTOLAUTA - TAKBRÄDE  88mm or-tai-eller 114mm	18+1 24+1	18x114 18x88	1680
R3	ROOFBOARD - KATTOLAUTA - TAKBRÄDE  88mm or-tai-eller 114mm	36 46	18x114 18x88	1220
FF	FLOOR FILLET - LATTIALISTA - GOLVLIST 		18x35	13jm
GB1	GABLE BOARD - KAAPELILAUTA - GAVELBRÄDA 	6	18x90	2060
GB2		4	18x90	1031
GS	GABLE SLAT - KAAPELILISTA - VINDLIST 	4	30x40	2060
GCB	GABLE BOARD CONNECTING BOARD - KAAPELILAUTA YHDISTAMISLAUTA BRÄDE FÖR FIXERA VINDBRÄDE 	12	18x70	130
RFF1	ROOF FELT FILLET - KATON PÄÄTYLAUTA - BRÄDE OVANPÅ GAVELBRÄDE 	4	18x70	2070
RFF2		2	18x70	2010
EB1	EAVE BOARD - RÄYSTÄSLAUTA - TAKFOTSBRÄDE 	2	18x90	2080
EB2	EAVE BOARD - RÄYSTÄSLAUTA - TAKFOTSBRÄDE 	10	18x90	1725
EB3	EAVE BOARD - RÄYSTÄSLAUTA - TAKFOTSBRÄDE 	5	18x90	1680
EB4	EAVE BOARD - RÄYSTÄSLAUTA - TAKFOTSBRÄDE 	8	18x90	885
EB5	EAVE BOARD - RÄYSTÄSLAUTA - TAKFOTSBRÄDE 	2	18x120	2080
EB6	EAVE BOARD - RÄYSTÄSLAUTA - TAKFOTSBRÄDE 	2	18x90	1235
CB1	CORNER BOARD - KULMANLAUTA - HÖRNBRÄDE 	2	18x90	2090
CB2		6	18x90	2040
CB3	CORNER BOARD - KULMANLAUTA - HÖRNBRÄDE 	2	18x90	570
CB4	CORNER BOARD - KULMANLAUTA - HÖRNBRÄDE 	2	18x90	570
FIL1	FILLING BOARD- TÄYTTÖLAUTA- FYLLNADSBRÄDE 	2	16x80	2060
FIL2	FILLING BOARD- TÄYTTÖLAUTA- FYLLNADSBRÄDE 	2	16x70	2060



Polhus

















Kood Friggebod Christel

Materjal

File Friggebod Christel.dwg

Leht 19

2 PAKKI L<2.35m

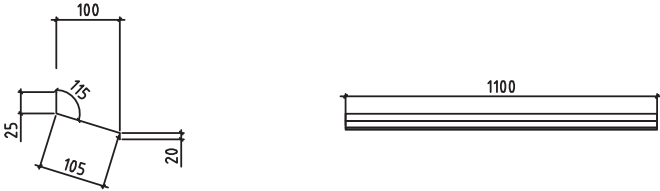
Pos	Friggebod Christel	Nr. Pcs.	Profile (mm)	L (mm)
	DOOR HANDLE - OVEN KAHVA - DÖRR HANDTAG 	1		
	DOOR LOCK+KEYS - OVENLUKKO+AVAIN - DÖRRLAS+NYCKLAR 	1		
	WINDOW HANDLE - IKKUNA KAHVA - FÖNSTER HANDTAG 	1+1+1		
	STEEL CORNER - KULMARAUTA - VINKELJÄRN 	10	90x90	65
	STEEL PLATE - METALLILEVY - METALLPLATTA 	2 2	2,5x60 2,5x60	160 120
	NAILS - NAULAT - SPIKAR  FERMS - KATTOPARRU - TAKLÄGGNING	108	5,0	120
	NAILS - NAULAT - SPIKAR  FLOORBOARD - LATTIALAUTA - GOLVBRÄDE	700	2,5	60
	NAILS - NAULAT - SPIKAR  ROOFBOARD - KATTOLAUTAT - TAKBRÄDE	32	2,0	40
	NAILS - NAULAT - SPIKAR  SKIRTING SLAT - LATTIALISTA - GOLVLIST			
	SCREW - RUUVIT - SKRUVAR  ELEMENT - ELEMENT - ELEMENTTI <small>EL-9 & EL-10 EL-11 & EL-12</small>	18	5,0	120
	SCREW - RUUVIT - SKRUVAR  FLOORBEAMS - LATTIAPALKIT - GOLVBÄLJKAR	225	4,5	70
	SCREW - RUUVIT - SKRUVAR  ELEMENT CONNECTING - ELEMENTTI YHDISTAMIS	40	5,0	40
	SCREW - RUUVIT - SKRUVAR  STEEL PLATE - METALLILEVY - METALLPLATTA			
	SCREW - RUUVIT - SKRUVAR  STEEL CORNER - KULMARAUTA - VINKELJÄRN EAVE BOARD - RÄYSTÄSLAUTA - TAKFOTSBRÄDE	370	4,5	45
	SCREW - RUUVIT - SKRUVAR  CORNER BOARD - KULMANLAUTA - HÖRNBRÄDE			
	SCREW - RUUVIT - SKRUVAR  GABLE BOARD - KAAPELILAUTA - GAVELBRÄDA GABLE SLAT - KAAPELLISTA - VINDLIST			
	SCREW - RUUVIT - SKRUVAR  ROOF FELT FILLET - KATON PÄÄTYLAUTA - BRÄDE OVANPÅ GAVELBRÄDE			
WS-1	<p>WATER SILL</p> 	2		



Polhus

Kood Friggebod Christel

Materjal

File Friggebod Christel.dwg

Leht 20

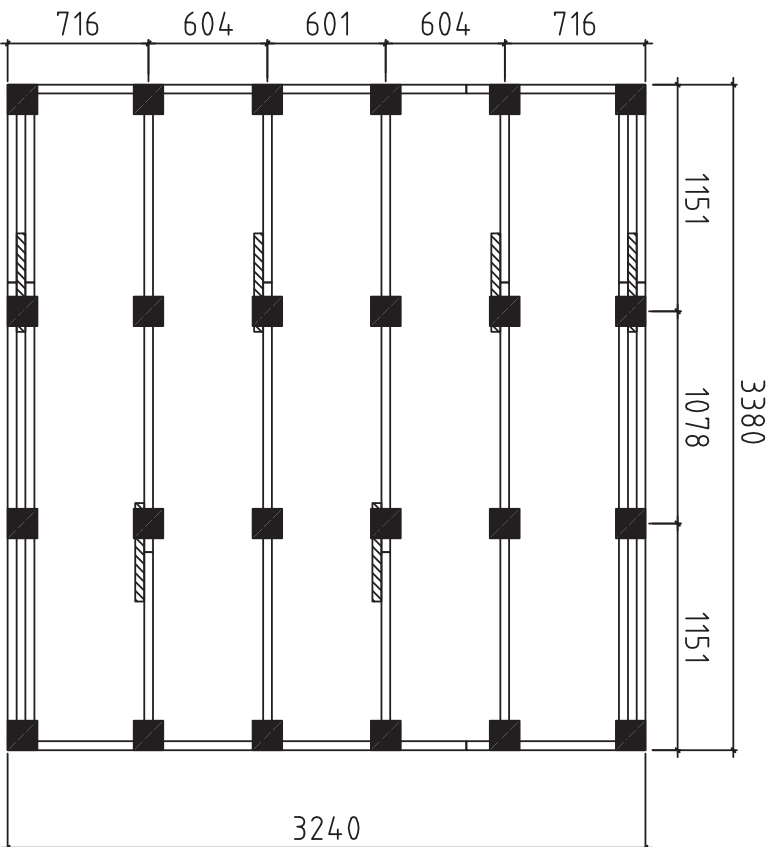

Detta är ett förslag för hur man kan placera plintarna (100-200 mm i diameter) för golvjälklaget. Golvjälkarna är med i byggsatsen, men inte plintarna. Använder man exempelvis 500-600mm långa murblock så kan man halvera antalet punkter. Lägg fuktskyddande papp mellan betong och trä

Tänå or ehdotus siitä, miten (100-200 mm läpimittaiset) jalat voidaan sijoittaa alapohjaa varten. Lattjapalkit ovat rakennussarjassa, mutta jalat ei ole. Kun käytetään esimerkiksi 500-600 mm pitkiä harkkoja, voidaan pisteyden määrä puolittaa. Aseta betoniin ja puun väliin kosteudelta suojaava pappi

A proposal for placing plinths (100-200 mm in diameter) for floor beams. Floor beams are provided in the kit but plinths are not included. For example, by using 500-600 mm long masonry units, one can reduce the number of points 50%. Place cardboard between the concrete and wood to protect from moisture

Date rev. Description

House	Friggebod Christel	Sheet
-------	--------------------	-------

Drawing	Plan	Scale	1:35
---------	------	-------	------

Material		Date	13.01.2021
----------	--	------	------------

Drawer	K.K.	File	Friggebod Christel.dwg
--------	------	------	------------------------

