

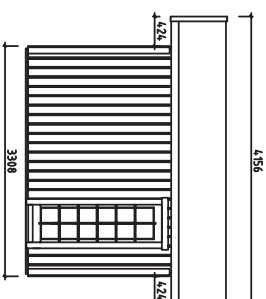

# Views and ground plan - Fasader och grundplan - Julkisivut ja pohjapiirustus

Roof MAX 100kg/m<sup>2</sup>

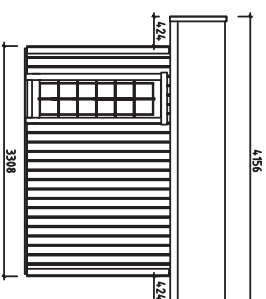
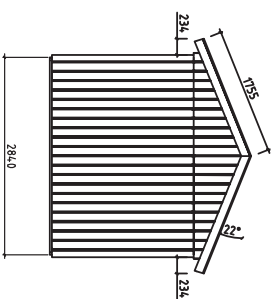
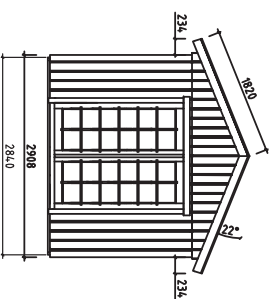
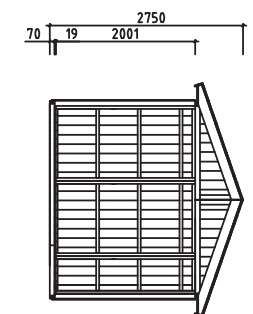
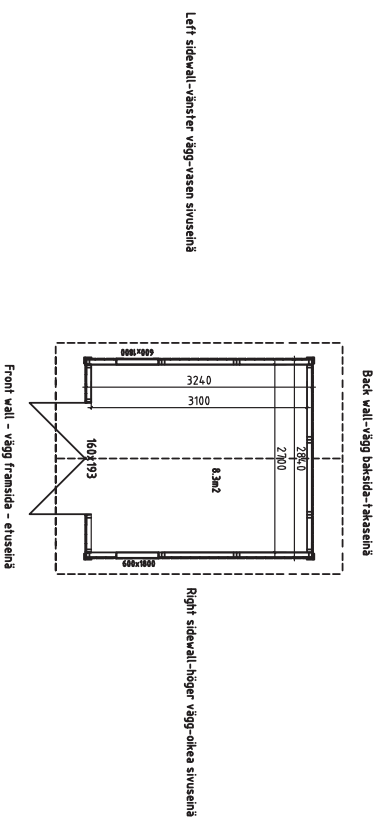

V 1.0

		House	Sheet
		Friggebod Hedvig	1
Drawing	Scale	1:100	
Material	Date	03.02.2021	
Drawer	File	Friggebod Hedvig.dwg	
		K.K.	

# Overview description of the manual - Översikts beskrivning för montering - Kokoonpano - ohjeiden kuvaminen

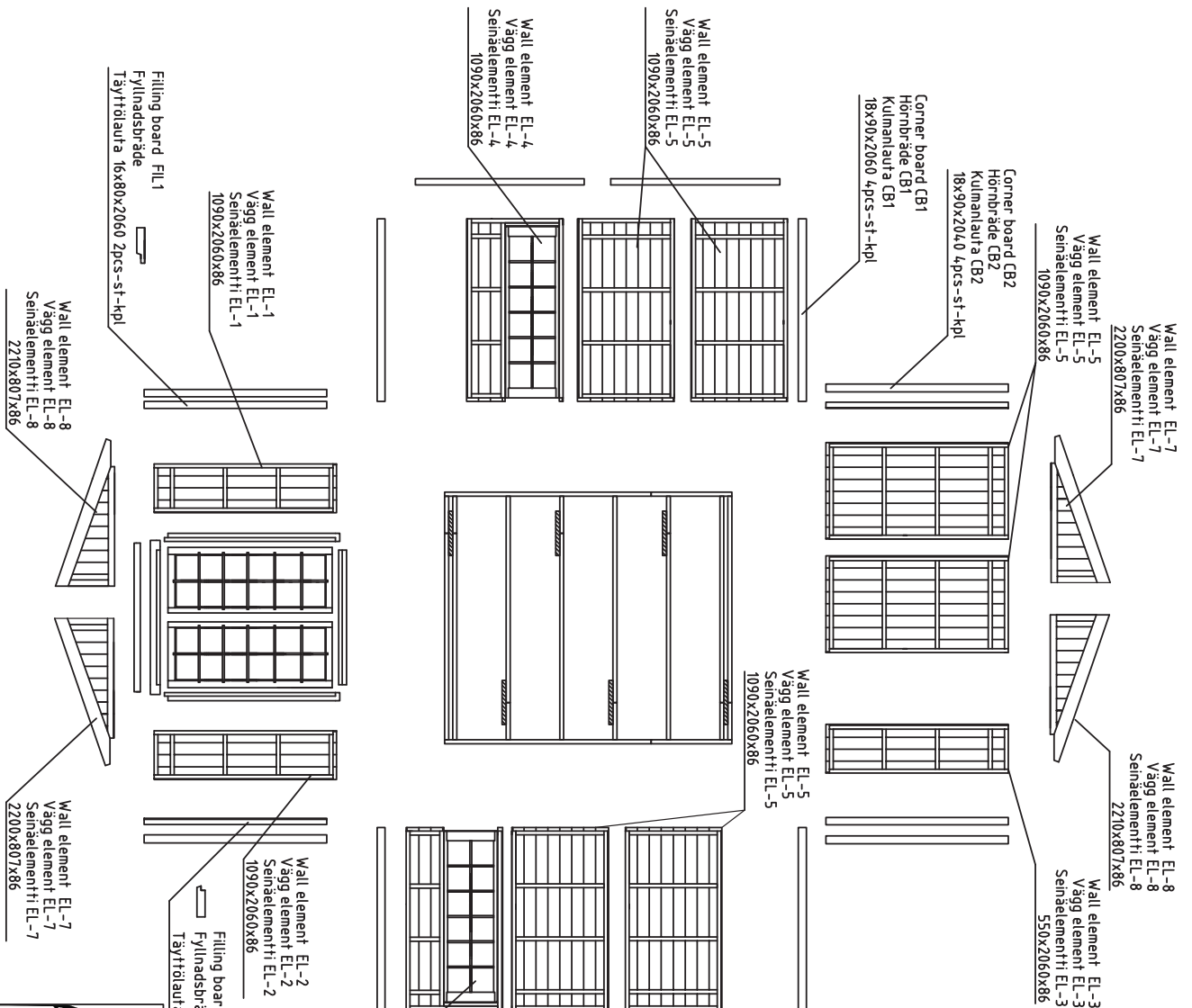

2060	Roofboard 32pcs (18x114) or 42pcs (18x88)	R1
1614	Takbräde 32st (18x114) och 42st (18x88) Kattrolaiva 32kpl (18x114) tai 42kpl (18x88)	
1253	Roofboard 16pcs (18x114) or 21pcs (18x88)	R2
1614	Takbräde 16st (18x114) och 21st (18x88) Kattrolaiva 16kpl (18x114) tai 21kpl (18x88)	
1950	Roofboard 32pcs (18x114) or 42pcs (18x88)	R3
1253	Takbräde 32st (18x114) och 42st (18x88) Kattrolaiva 32kpl (18x114) tai 42kpl (18x88)	
1850	Floorboard 24pcs (18x114) or 32pcs (18x88)	F1
1250	Golvbräde 24st (18x114) och 32st (18x88) Lattialaiva 24kpl (18x114) tai 32kpl (18x88)	
1900	Floorboard 24pcs (18x114) or 32pcs (18x88)	F2
1900	Golvbräde 24st (18x114) och 32st (18x88) Lattialaiva 24kpl (18x114) tai 32kpl (18x88)	
1806	Floor filler 9pcs 18x35	FF
1163	Golvväli 9st 18x35 Lattialista 9kpl 18x35	
1806	Gable board 4pcs 18x120	GB
1746	Gavelbräda 4st 18x120 Kaapelilaiva 4kpl 18x120	
1806	Gable slat 4pcs 30x40	GS
1746	Vindlist 4st 30x40 Kaapelilista 4kpl 30x40	
2060	Roof felt filler 4pcs 18x35	RF
1636	Bräde ovanpå gavelbräde 4st 18x35 Katon päällylaiva 4kpl 18x35	
1636	Eave boards 4pcs 18x120	EB1
1636	Takfotsbräde 4st 18x120 Räystäslautta 4kpl 18x120	
1636	Eave boards 4pcs 18x90	EB2
1636	Takfotsbräde 4st 18x90 Räystäslautta 4kpl 18x90	
1636	Eave boards 4pcs 18x90	EB3
1636	Takfotsbräde 4st 18x90 Räystäslautta 4kpl 18x90	

**Polhus**

<b>House</b>	<b>Sheet</b>
Friggebod Hedvig	2
<b>Drawing</b>	<b>Scale</b>
	1:35
<b>Material</b>	<b>Date</b>
	03.02.2021
<b>Drawer</b>	<b>File</b>
K.K.	Friggebod Hedvig.dwg

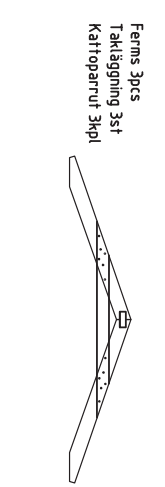

**Side wall connecting beam SCB**  
 Bjälkar för sidovägg  
 sammanslagning  
 Sivuseinä yhdistämisspalkit  
 70x43x1636 4pcs-st-kpl



Installation of wall element EL-1 - monterering av vägg element EL-1 - seinäelementin EL-1 asennus  
(Front wall - vägg framsida - etuseinä)

View from inside - Från insidan - Näkymä sisältä

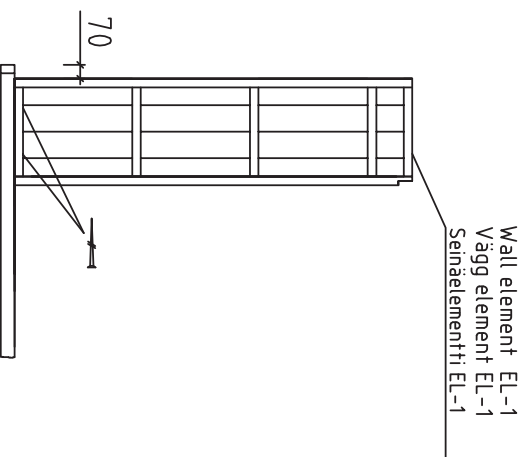

Fix wall element EL-1 with screws  
4.5x70 into floorbeam

Fixera vägg element EL-1 med skruvar  
4.5x70 i golvbjälke

Kiinnitä seinäelementti EL-1 ruuveilla  
4.5x70 lattipalkkin

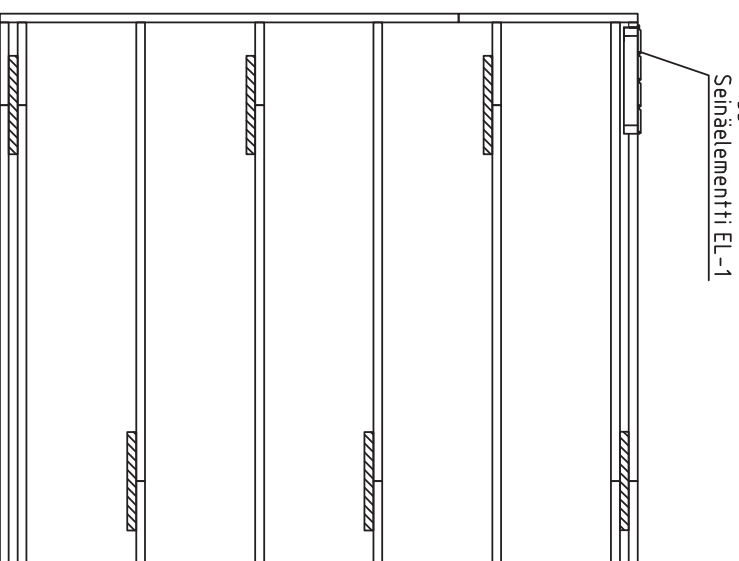

	House	Friggebod Hedvig	Sheet	4
	Drawing		Scale	1:35
	Material		Date	03.02.2021
Drawer	K.K.	File	Friggebod Hedvig.dwg	

Installation of wall element EL-1 and EL-2 - monterering av vägg element EL-1 och EL-2 -seinäelementin EL-1 ja EL-2 asennus  
(Front wall - vägg framsida - etuseinä)

View from inside - Från insidan - Näkymä sisältä

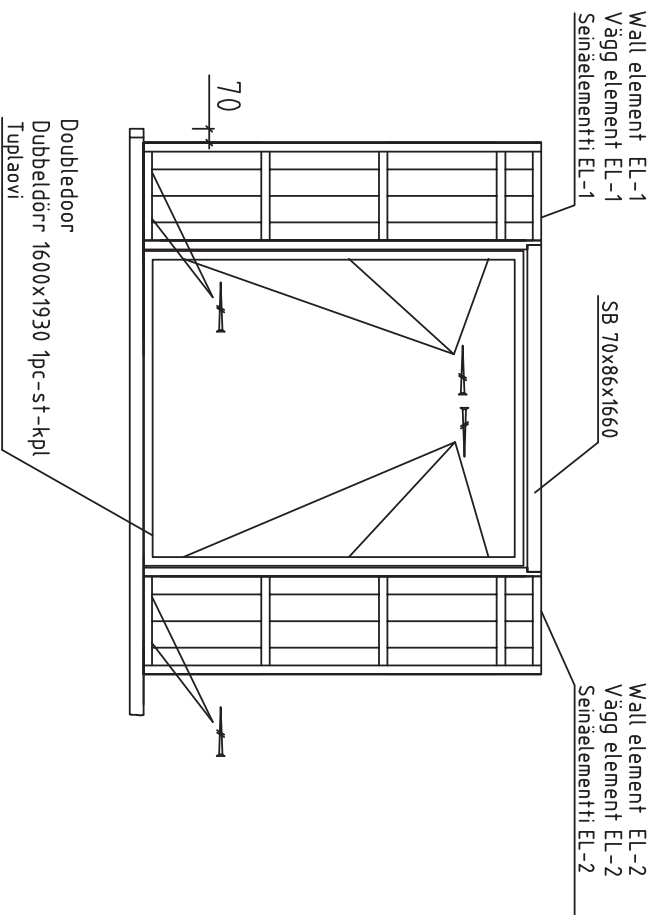

Fix wall element EL-2 with screws

4.5x70 into floorbeam

Fixera vägg element EL-2 med skruvar

4.5x70 i golvbjälke

Kiinnitä seinäelementti EL-2 ruuveilla

4.5x70 lattiapalkkin

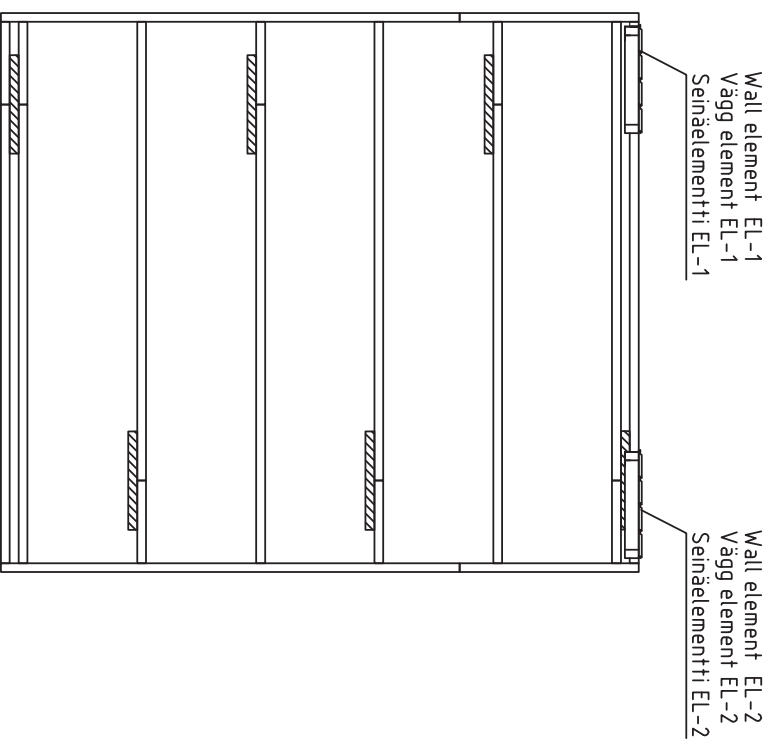

 <b>Polhus</b>		House	Friggebod Hedvig	Sheet	5
		Drawing		Scale	1:35
		Material		Date	03.02.2021
Drawer	K.K.	File	Friggebod Hedvig.dwg		

## Installation of left sidewall – montering av vänster sidovägg – vasen sivuseinä asennus

View from inside – Från insidan – Näkymä sisältä

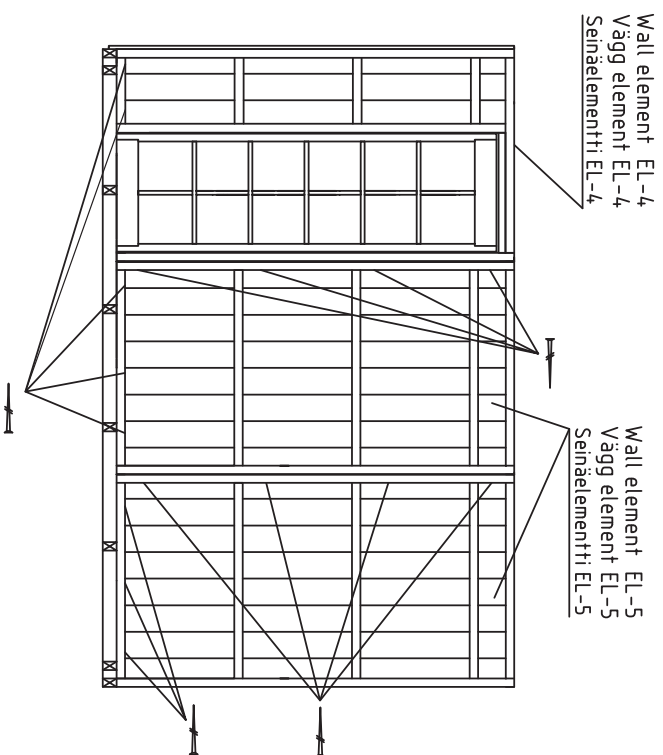

Fix wall element EL-4 (2pcs) and EL-5 (3pcs) with screws

4.5x70 into floorbeam

Fixera vägg element EL-4 (2pcs) och EL-5 (3st) med skruvar

4.5x70 i golvbjälke

Kiinnitä seinäelementti EL-4 (2pcs) ja EL-5 (3kpl) ruuveilla

4.5x70 lattiapalkkin

Fix wall elements EL-2 and EL-4 with screws 4.5x70 together

Fixera vägg element EL-2 och EL-4 med skruvar 4.5x70 tillsammans

Kiinnitä seinäelementit EL-2 ja EL-4 yhteen ruuveilla 4.5x70

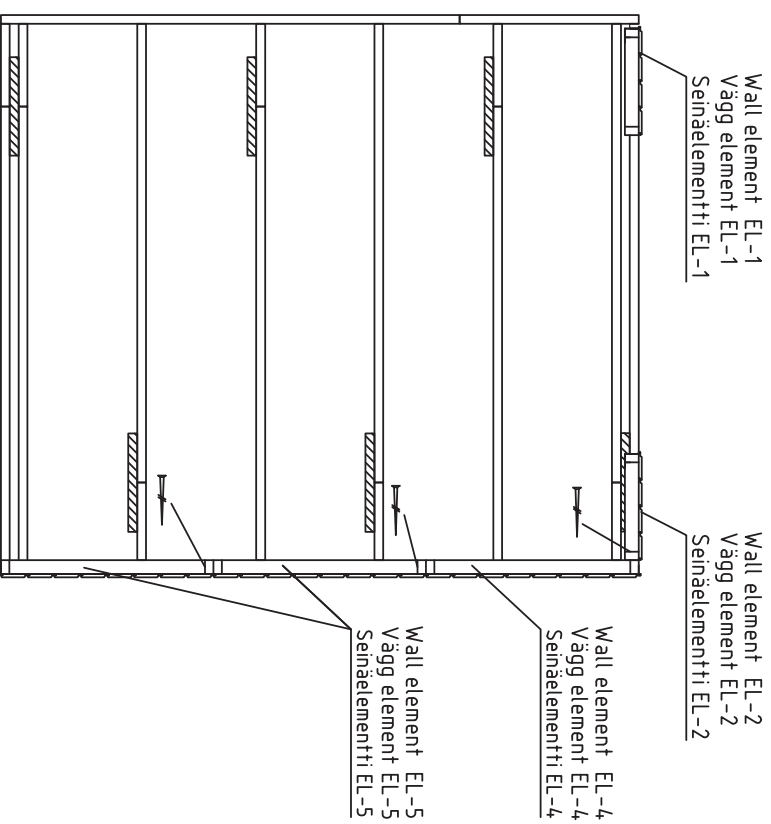

Wall element EL-1  
Vägg element EL-1  
Seinäelementti EL-1

Wall element EL-2  
Vägg element EL-2  
Seinäelementti EL-2

Wall element EL-4  
Vägg element EL-4  
Seinäelementti EL-4

Wall element EL-5  
Vägg element EL-5  
Seinäelementti EL-5

		House	Friggebod Hedvig	Sheet	6
		Drawing		Scale	1:35
Material		Date	03.02.2021		
Drawer	K.K.	File	Friggebod Hedvig.dwg		

## Installation of back wall – montering av vägg baksida – takaseinä asennus

View from inside – Från insidan – Nakyma sisältä

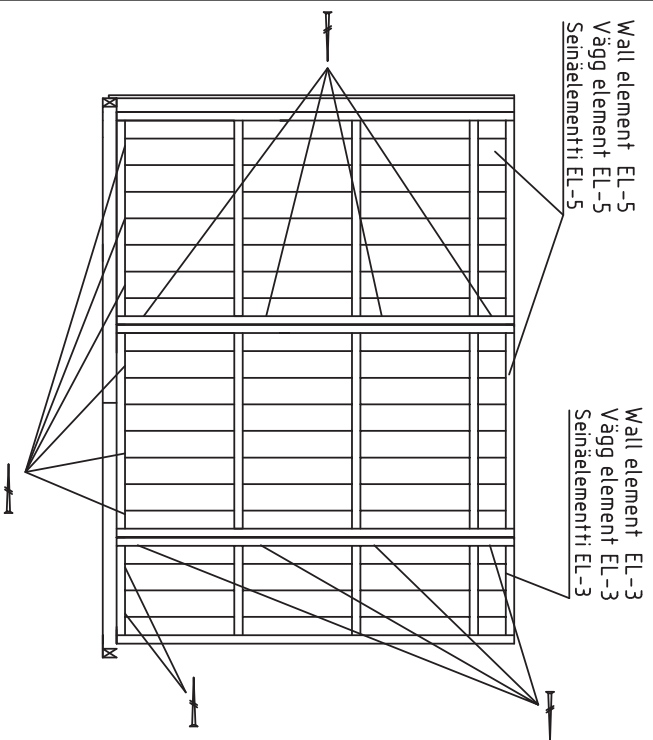

Fix wall element EL-3 (2pcs) and EL-5 (3pcs) with screws

4.5x70 into floorbeam

Fixera vägg element EL-3 (2pcs) och EL-5 (3st) med skruvar

4.5x70 i golvbjälke

Kiinnitä seinäelementti EL-3 (2pcs) ja EL-5 (3kpl) ruuveilla

4.5x70 lattiapalkkin

Fix wall elements EL-5 and EL-5 with screws 4.5x70 together

Fixera vägg element EL-5 och EL-5 med skruvar 4.5x70 tillsammans

Kiinnitä seinäelementit EL-5 ja EL-5 yhteen ruuveilla 4.5x70

Wäll element EL-3  
Vägg element EL-3  
Seinäelementti EL-3

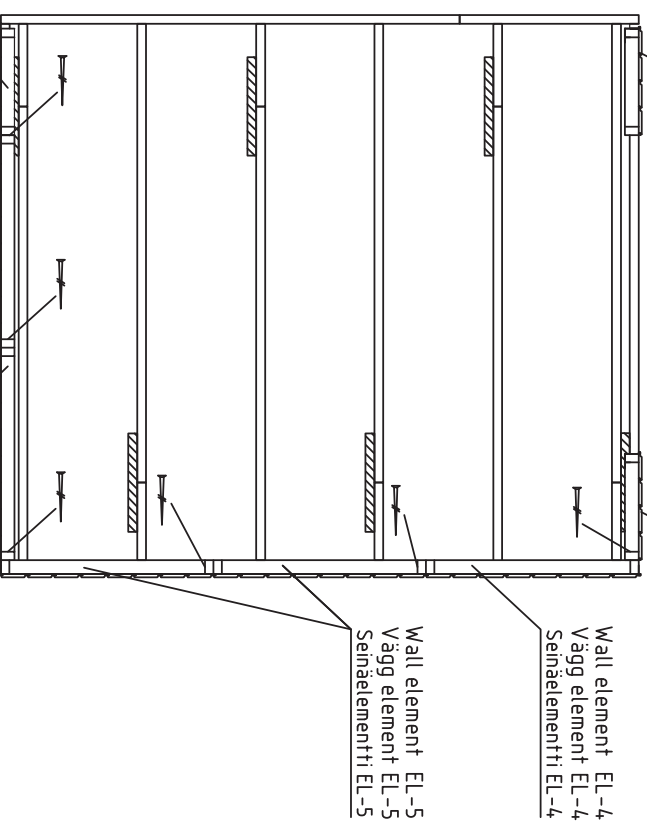

Wäll element EL-1  
Vägg element EL-1  
Seinäelementti EL-1

Wäll element EL-2  
Vägg element EL-2  
Seinäelementti EL-2

Wäll element EL-4  
Vägg element EL-4  
Seinäelementti EL-4

Wäll element EL-5  
Vägg element EL-5  
Seinäelementti EL-5

Wäll element EL-5  
Vägg element EL-5  
Seinäelementti EL-5

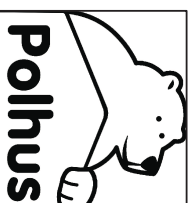

House	Friggebod Hedvig	Sheet	7
Drawing		Scale	1:35
Material		Date	03.02.2021
Drawer	K.K.	File	Friggebod Hedvig.dwg





Installation of sidewall connecting beams - montering av bjälkar för sidovägg sammanslagning - sivuseinä yhdistämispalkit asennus

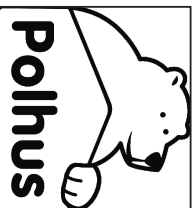
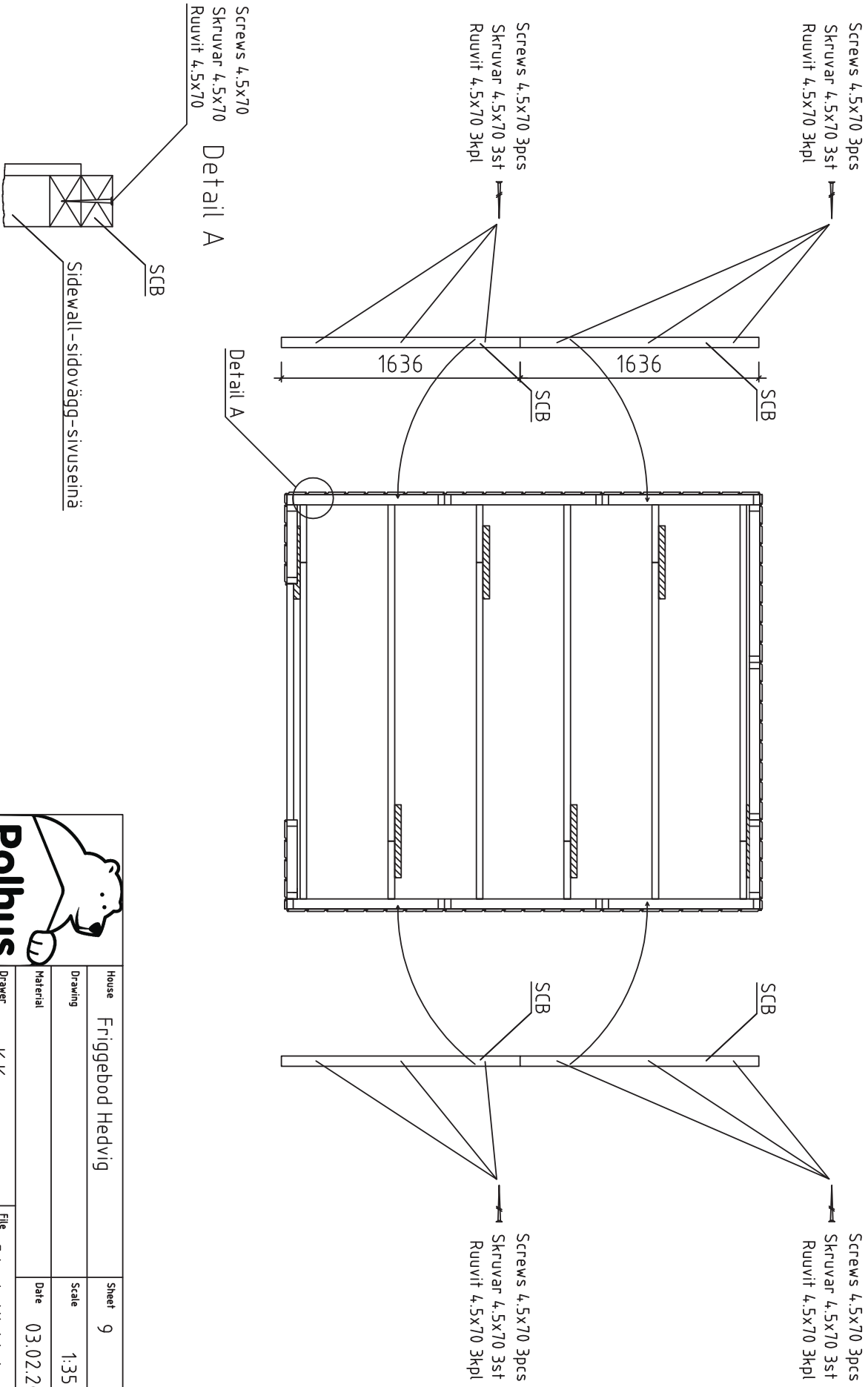

House	Friggebod Hedvig	Sheet	9
Drawing		Scale	1:35
Material		Date	03.02.2021
Drawer	K.K.	File	Friggebod Hedvig.dwg

# Installation of wall element EL-5 and EL-6 - montering av vägg element EL-5 och EL-6 -seinäelementin EL-5 ja EL-6 asennus (Front wall - vägg framsida - etuseinä)

View from inside - Från insidan - Näkymä sisältä

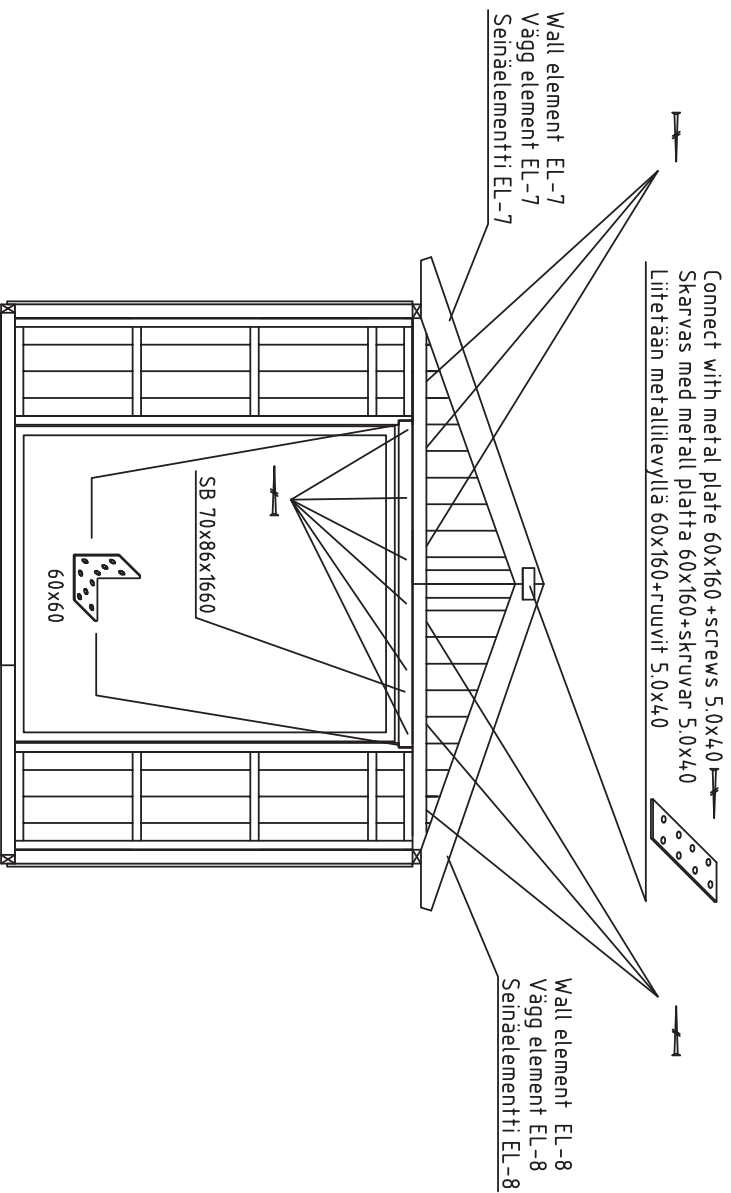

Fix wall element EL-5 with front wall elements with screws 5.0x120 together

Fixera vägg element EL-5 med elementat vägg framsida med skruvar 5.0x120 tillsammans

Kiinnitä seinäelementti EL-5 yhteen etuseinän elementit ruuveilla 5.0x120

Fix wall element EL-6 to front wall elements with screws 5.0x120 together

Fixera vägg element EL-6 med elementat vägg framsida med skruvar 5.0x120 tillsammans

Kiinnitä seinäelementti EL-6 yhteen etuseinän elementit ruuveilla 5.0x120

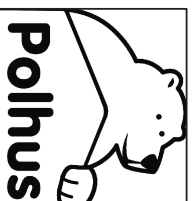

House	Frigegebod Hedvig	Sheet	10
Drawing		Scale	1:35
Material		Date	03.02.2021
Drawer	K.K.	File	Frigegebod Hedvig.dwg

Installation of wall element EL-5 and EL-6 – montering av vägg element EL-5 och EL-6 –seinäelementin EL-5 ja EL-6 asennus  
(Back wall –vägg baksida –takaseinä)

View from inside – Från insidan – Näkymä sisältä

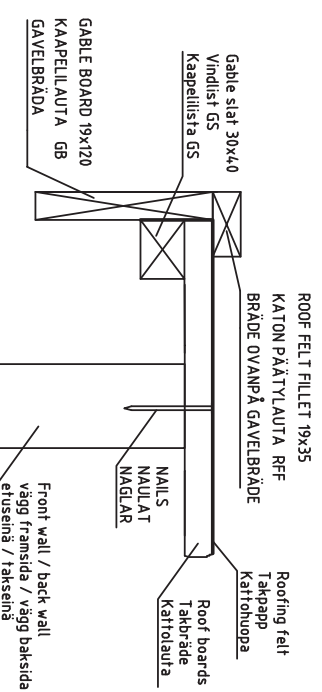
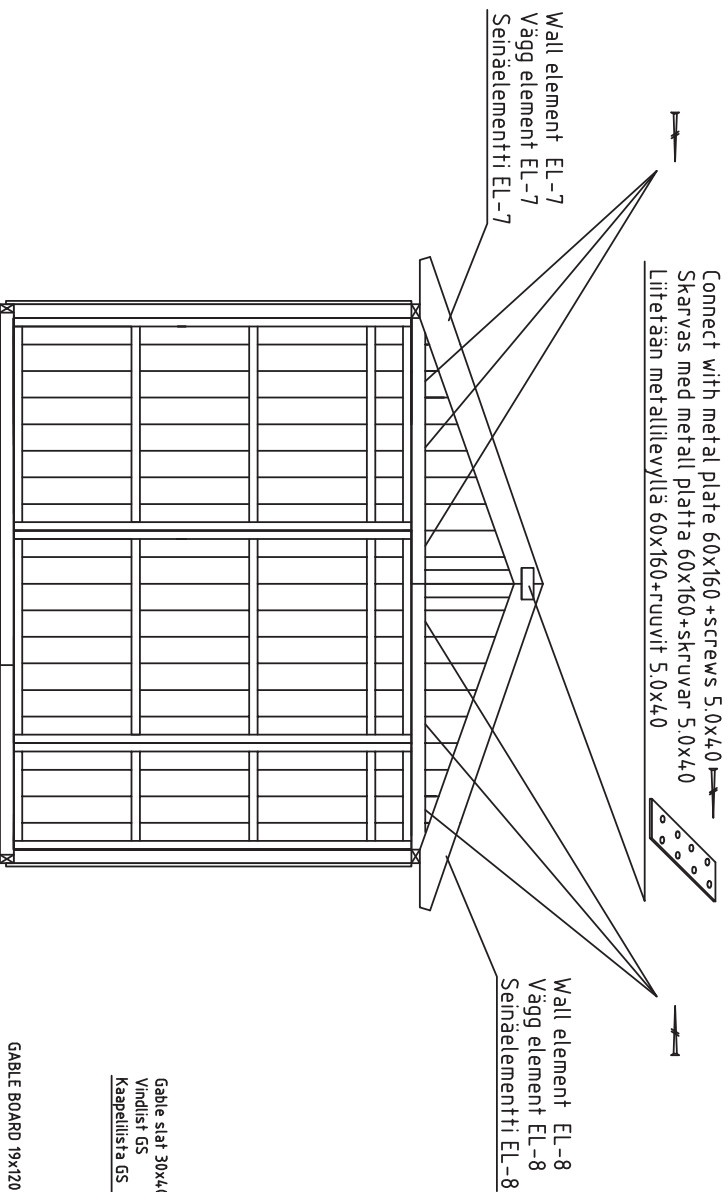

Fix wall element EL-5 with back wall elements with screws 5.0x120 together

Fixera vägg element EL-5 med elementat vägg baksida med skruvar 5.0x120 tillsammans

Kiinnitä seinäelementti EL-5 yhteen takaseinän elementit ruuvilla 5.0x120

Fix wall element EL-6 with back wall elements with screws 5.0x120 together

Fixera vägg element EL-6 med elementat vägg baksida med skruvar 5.0x120 tillsammans

Kiinnitä seinäelementti EL-6 yhteen takaseinän elementit ruuvilla 5.0x120

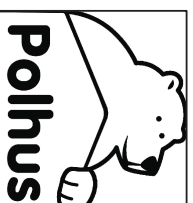

House	Friggebod Hedvig		Sheet	11
Drawing			Scale	1:35
Material			Date	03.02.2021
Drawer	K.K.	File	Friggebod Hedvig.dwg	

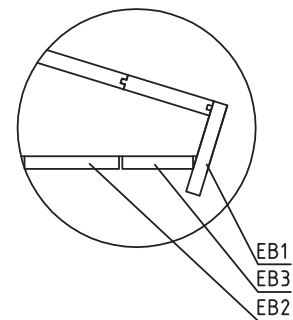
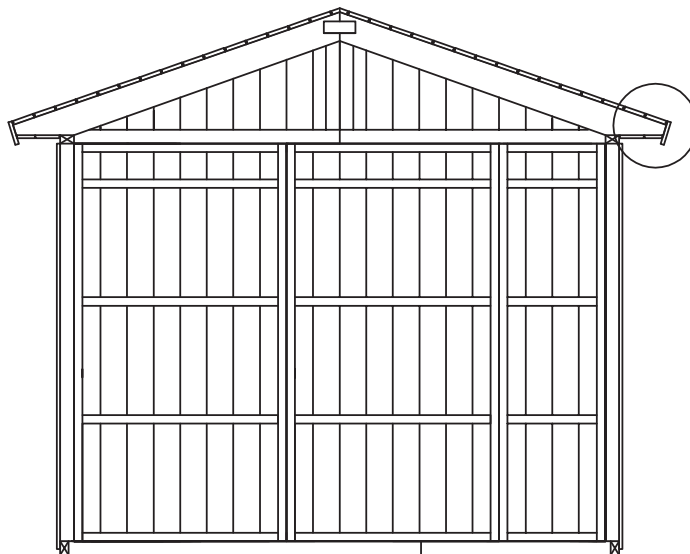
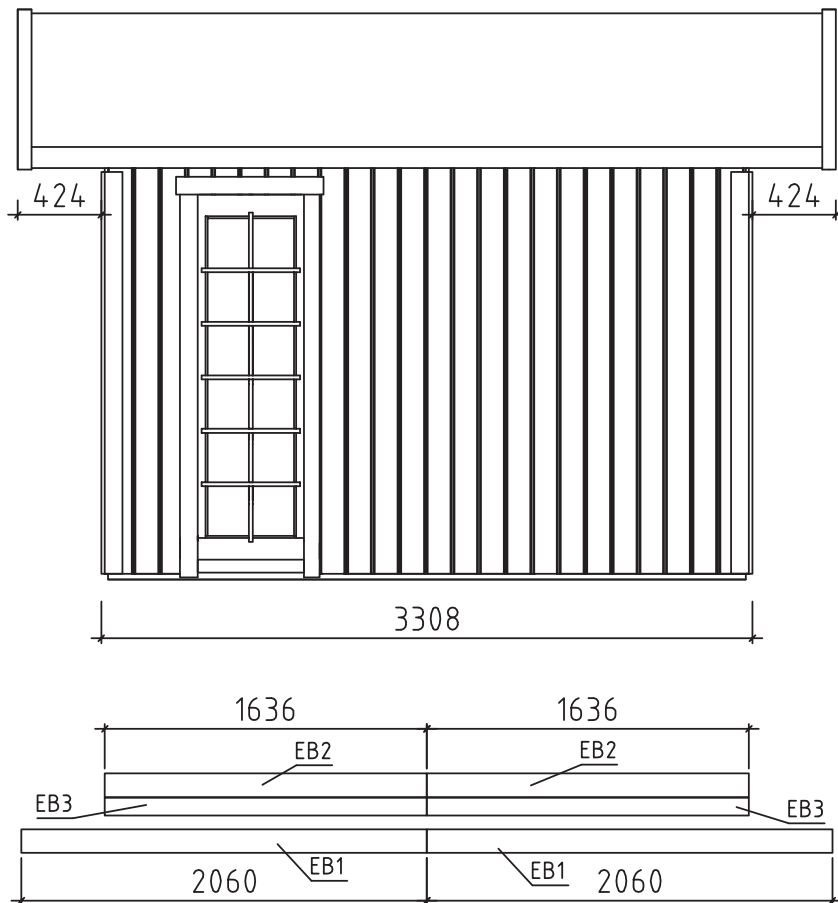

House	Friggebod Hedvig	Sheet	12
Drawing		Scale	1:35
Material		Date	03.02.2021
Drawer	K.K.	File	Friggebod Hedvig.dwg

# Ferms - Takläggning - Kattoparrut

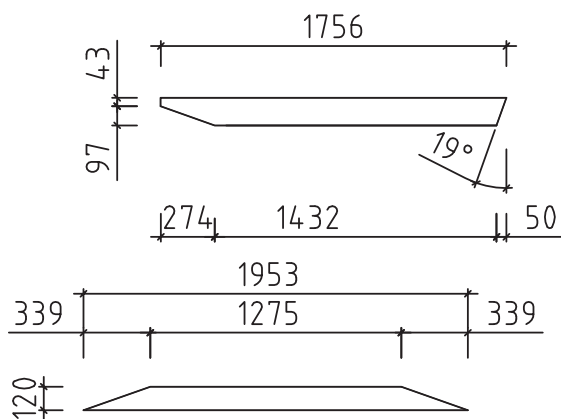

Rafter-kattopalki-takbjälkar 43x140x1756 6pcs-st-kpl

Tie beam-kattopalki-takbjälkar 28x120x1953 6pcs-st-kpl

Connect with metal plate 60x160  
+screws 5.0x40 12pcs  
on both sides of the ferm

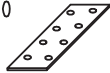

Skarvas med metall platta 60x160+skruvar 5.0x40  
båda sidor takläggning  
Liitetään metallilevyllä 60x160+ruuvit 5.0x40  
molemmin puolin kattoparru

Ferms 3pcs  
Takläggning 3st  
Kattoparrut 3kpl

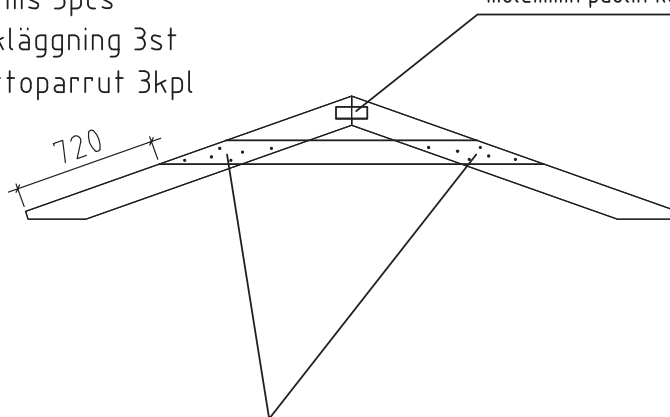

Connect with nails 4x100 (6+6)  
on both sides of the ferm

Skarvas med spikar 4x100 (6+6)  
båda sidor takläggning

Liitetään naulalla 4x100 (6+6)  
molemmin puolin kattoparru



House	Friggebod Hedvig	Sheet	13
Drawing		Scale	1:35
Material		Date	03.02.2021
Drawer	K.K.	File	Friggebod Hedvig.dwg

## Ferm install-installerä takläggning-kattoparru asennus

- Roofboard L=2060mm
- Takbräde L=2060mm R1
- Kattolautta L=2060mm
- Roofboard L=1253mm
- Takbräde L=1253mm R3
- Kattolautta L=1253mm

Connect with steel corner 90x90x65+screws 4,5x4,5 8pcs  
 Skarvas med metallvinkel 90x90x65+skruvar 4,5x4,5 8st  
 Liitään kulmarautaan 90x90x65+ruuvit 4,5x4,5 8kpl

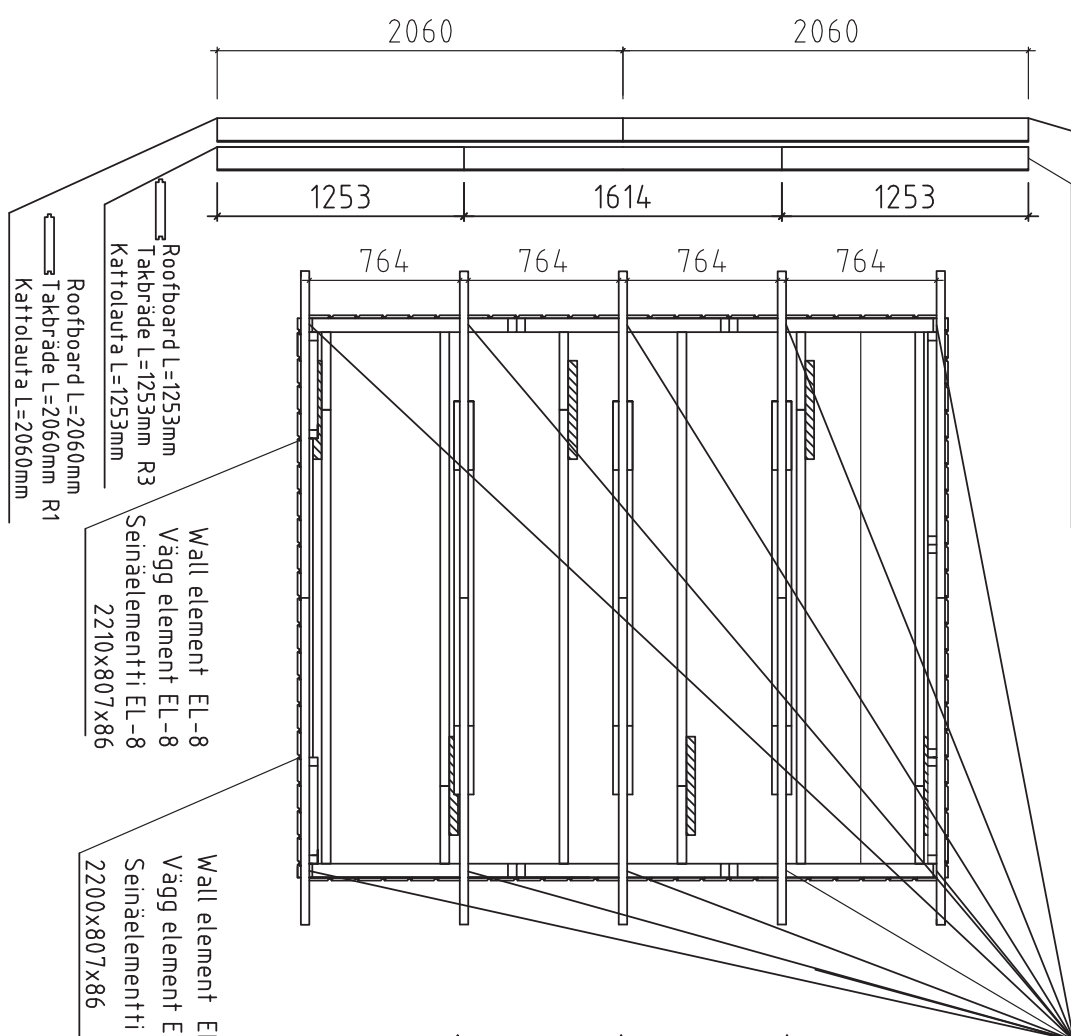

- Roofboard L=1253mm
- Takbräde L=1253mm R3
- Kattolautta L=1253mm
- Roofboard L=2060mm
- Takbräde L=2060mm R1
- Kattolautta L=2060mm
- Wall element EL-8
- Vägg element EL-8
- Seinäelementti EL-8
- 2210x807x86
- Wall element EL-7
- Vägg element EL-7
- Seinäelementti EL-7
- 2200x807x86

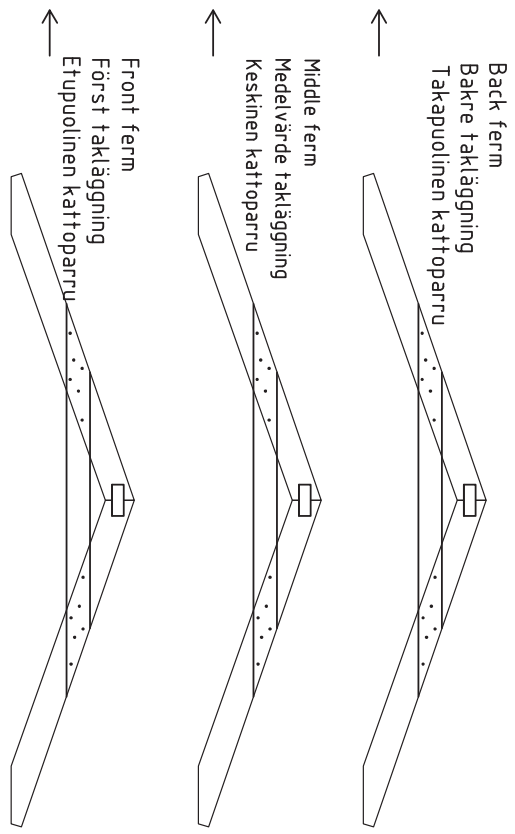

NB!!! Change the roofboard positions after every row  
 NB!!! Skarva tak bräderna olika efter varje rad  
 NB!!! Muuta kattolautojen sijaintia jokaisen rivin jälkeen

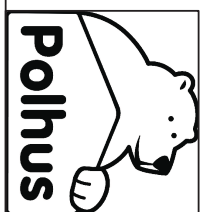

House	Friggebod Hedvig	Sheet	14
Drawing		Scale	1:35
Material		Date	03.02.2021
Drawer	K.K.	File	Friggebod Hedvig.dwg

2 PAKKI L<2.35m

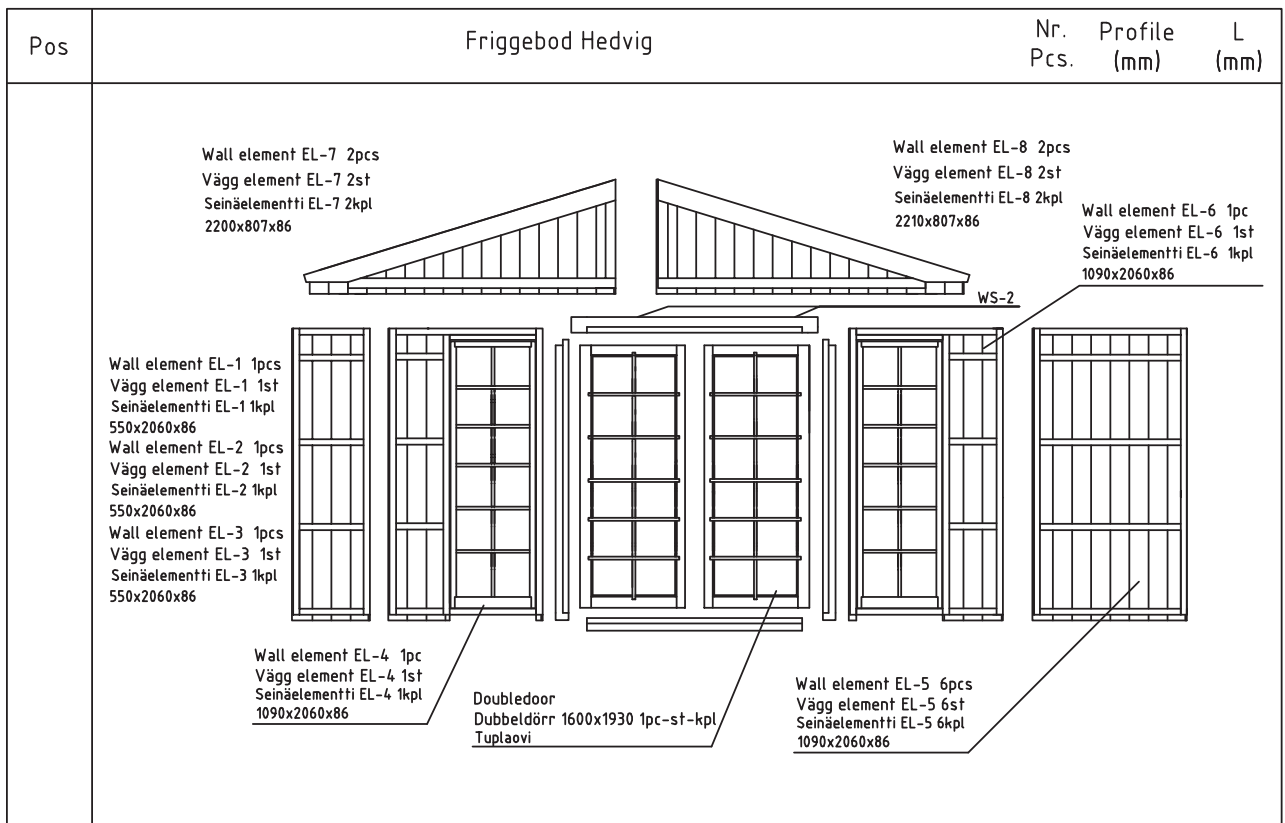

RA	RAFTER - KATTOPALKI - TAKBJÄLKAR		6	43x140	1756
TB	TIE BEAM - KATTOPALKI - TAKBJÄLKAR		6	28x120	1953
FB1	FLOORBEAM - LATTIAPALKI - GOLVBJÄLKAR		10	45x90	2330
FB2	FLOORBEAM - LATTIAPALKI - GOLVBJÄLKAR		2	45x90	910
FB3	FLOORBEAM - LATTIAPALKI - GOLVBJÄLKAR		8	45x90	420
FB4	FLOORBEAM CONNECTING BEAM - LATTIAPALKI YHDISTAMISPALKIT BRÄDE FÖR GOLVBJÄLKAR SAMMANSLAGNING		6	45x90	500
SCB	SIDEWALL CONNECTING BEAM - SIVUSEINÄ YHDISTAMISPALKIT BJÄLKAR FÖR SIDOVÄGG SAMMANSLAGNING		4	45x70	1636
F1	FLOORBOARD - LATTIALAUTA - GOLVBRÄDE	88mm or -tai- eller 114mm	24 32	18x114 18x88	1850 1850
F2	FLOORBOARD - LATTIALAUTA - GOLVBRÄDE	88mm or -tai- eller 114mm	24 32	18x114 18x88	1250 1250
R1	ROOFBOARD - KATTOLAUTA - TAKBRÄDE	88mm or -tai- eller 114mm	32+1 42+1	18x114 18x88	2060 2060
R2	ROOFBOARD - KATTOLAUTA - TAKBRÄDE	88mm or -tai- eller 114mm	16+1 21+1	18x114 18x88	1614 1614
R3	ROOFBOARD - KATTOLAUTA - TAKBRÄDE	88mm or -tai- eller 114mm	32 42	18x114 18x88	1253 1253
FF	FLOOR FILLET - LATTIALISTA - GOLVLIST		9	18x35	1900
GB	GABLE BOARD - KAAPILILAUTA - GAVELBRÄDA	1806 1763	4	18x120	1806
RFF	ROOF FELT FILLET - KATON PÄÄTYLAUTA - BRÄDE OVANPÅ GAVELBRÄDE		4	18x35	2060



Polhus

Kood Friggebod Hedvig

Materjal

File Friggebod Hedvig.dwg

Leht 15

# 2 PAKKI L<2.35m

Pos	Friggebod Hedvig		Nr. Pcs.	Profile (mm)	L (mm)	
GS	GABLE SLAT - KAAPELILISTA - VINDLIST		4	30x40	1806	
EB1	EAVE BOARD - RÄYSTÄSLAUTA - TAKFOTSBRÄDE		4	18x120	2060	
EB2	EAVE BOARD - RÄYSTÄSLAUTA - TAKFOTSBRÄDE		4	18x120	1636	
EB3	EAVE BOARD - RÄYSTÄSLAUTA - TAKFOTSBRÄDE		4	18x90	1636	
CB1	CORNER BOARD - KULMANLAUTA - HÖRNBRÄDE		4	18x90	2060	
CB2	CORNER BOARD - KULMANLAUTA - HÖRNBRÄDE		4	18x90	2040	
FIL1	FILLING BOARD- TÄYTTÖLAUTA- FYLLNADSBRÄDE		2	16x80	2060	
FIL2	FILLING BOARD- TÄYTTÖLAUTA- FYLLNADSBRÄDE		2	16x70	2060	
SB	SUPPORTING BEAM - TUKIPALKI-STÖDBJÄLKE		1	70x86	1660	
	WINDOW CROSSES - IKKUNARISTIKKO - SPRÖJS		2			
	DOORCROSSES - OVENRISTIKKO - SPRÖJS		2			
	DOOR HANDLE - OVEN KAHVA - DÖRR HANDTAG		1			
	DOOR LOCK+KEYS - OVENLUKKO+AVAIN - DÖRRLAS+NYCKLAR		1			
	STEEL CORNER - KULMARAUTA - VINKELJÄRN		10	90x90	65	
	STEEL CORNER - KULMARAUTA - VINKELJÄRN		2	60x60	60	
	STEEL PLATE - METALLILEVY - METALLPLATTA		10	2,5x60	160	
	NAILS - NAULAT - SPIKAR		FERMS - KATTOPARRU - TAKLÄGGNING	72	4,0	100
	NAILS - NAULAT - SPIKAR		FLOORBOARD - LATTIALAUTA - GOLVBRÄDE	470	2,5	60
	NAILS - NAULAT - SPIKAR		ROOFBOARD - KATTOLAUTAT - TAKBRÄDE	35	2,0	40
	NAILS - NAULAT - SPIKAR		SKIRTING SLAT - LATTIALISTA - GOLVLIST			
	SCREW - RUUVIT - SKRUVAR		ELEMENT - ELEMENT - ELEMENTTI	12	5,0	120
	SCREW - RUUVIT - SKRUVAR		FLOORBEAMS - LATTIAPALKIT - GOLVBÄLJKAR	155	4,5	70
	SCREW - RUUVIT - SKRUVAR		ELEMENT CONNECTING - ELEMENTTI YHDISTÄMIS - ELEMENT SAMMANSLÄGNING	100	5,0	40
	SCREW - RUUVIT - SKRUVAR		STEEL PLATE - METALLILEVY - METALLPLATTA			
	SCREW - RUUVIT - SKRUVAR		STEEL CORNER - KULMARAUTA - VINKELJÄRN EAVE BOARD - RÄYSTÄSLAUTA - TAKFOTSBRÄDE CORNER BOARD - KULMANLAUTA - HÖRNBRÄDE GABLE BOARD - KAAPELILAUTA - GAVELBRÄDA GABLE SLAT - KAAPELILISTA - VINDLIST ROOF FELT FILLET - KATON PÄÄTYLAUTA - BRÄDE OVANPÅ GAVELBRÄDE	200	4,5	45
	SCREW - RUUVIT - SKRUVAR			50	3,0	30
WS-2	WATER SILL			1		



Polhus

Kood Friggebod Hedvig

Materjal

File Friggebod Hedvig.dwg

Leht 16

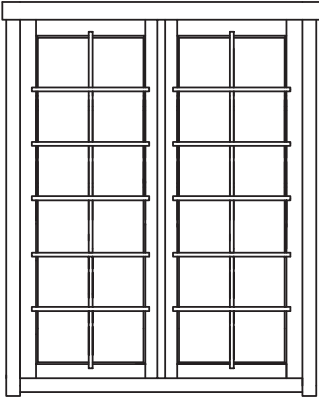
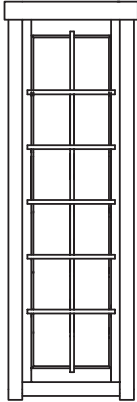

2 PAKKI L<2.35m

Pos	Friggebod Hedvig	Nr. Pcs.	Profile (mm)	L (mm)
	<p style="text-align: center;">Doubledoor 1600x1930 (right) 1pc</p>  <p style="text-align: right;">AST_ISO</p>	1	88x1600	1930
	<p style="text-align: center;">Window 600x1930 2pc</p>  <p style="text-align: right;">AST_ISO_K</p>	2	88x600	1930

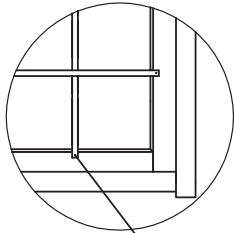

SCREW - RUUVIT - SKRUVAR  
3,0x30



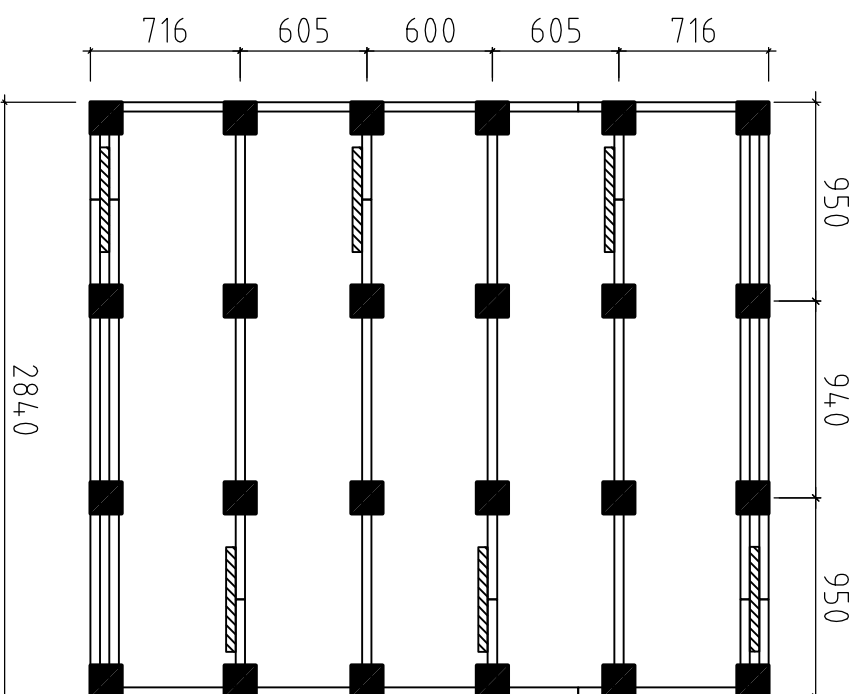

A proposal for placing plinths (100-200 mm in diameter) for floor beams. Floor beams are provided in the kit but plinths are not included. For example, by using 500-600 mm long masonry units, one can reduce the number of points 50%.

Tämä on ehdotus siitä, miten (100-200 mm läpimittaiset) jalat voidaan sijoittaa alapohjaa varten. Lattiapalkit ovat rakennussarjassa, mutta jalkoja ei ole. Kun käytetään esimerkiksi 500-600 mm pitkiä harkkoja, voidaan pisteiden määrä puolittaa.

Detta är ett förslag för hur man kan placera plintarna (100- 200 mm i diameter) för golvljällklaget. Golvljällkarna är med i byggsatsen, men inte plintarna. Använder man exempelvis 500-600mm långa murblock så kan man halvera antalet punkter.

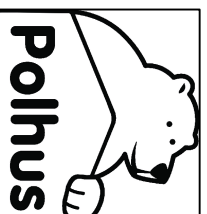

House	Friggebod Hedvig	Sheet	18
Drawing	FOUNDATION PLAN - PLINTPLAN	Scale	1:35
Material		Date	03.02.2021
Drawer	K.K	File	Friggebod Hedvig.dwg