

# Views and ground plan - Fasader och grundplan - Julkisivut ja pohjapiirustus

Back wall - vägg bakside-fäsesida

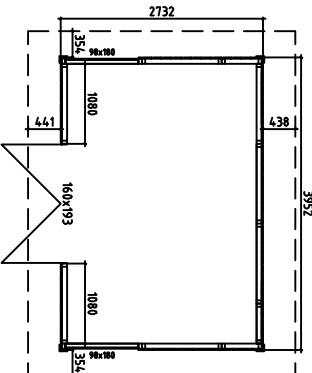

Roof MAX 100kg/m<sup>2</sup>

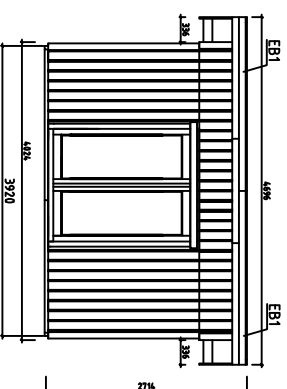
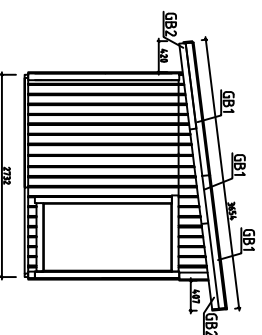

Left sidewall - vänster vägg-vasen sivusina

Right sidewall - höger vägg-ohka sivusina

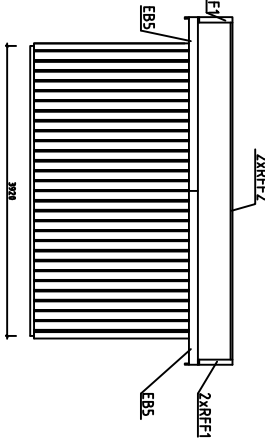
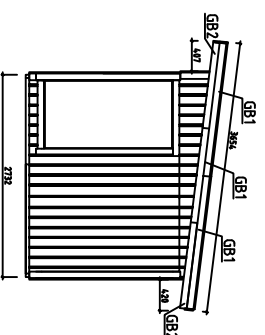
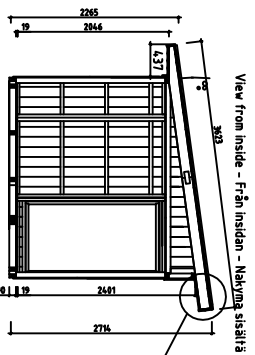

View from inside - Från insidan - Näkymä sisältä

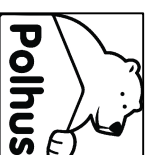
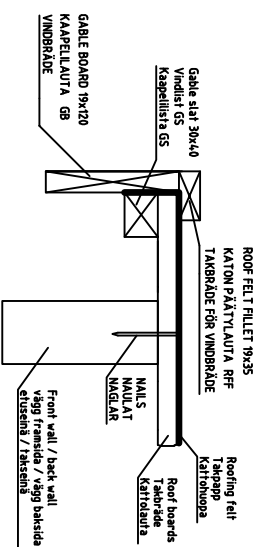
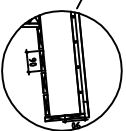

Date	rev.	Description	Sheet
			1
House	EL Julian	Drawing	Scale
			1:100
Material		Date	25.03.2021
Drawer	K.K.	File	EL Julian.dwg

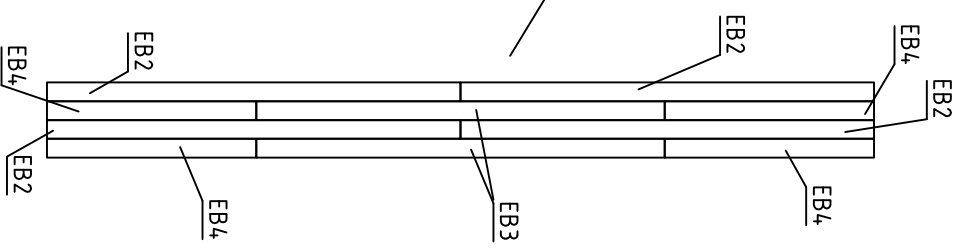
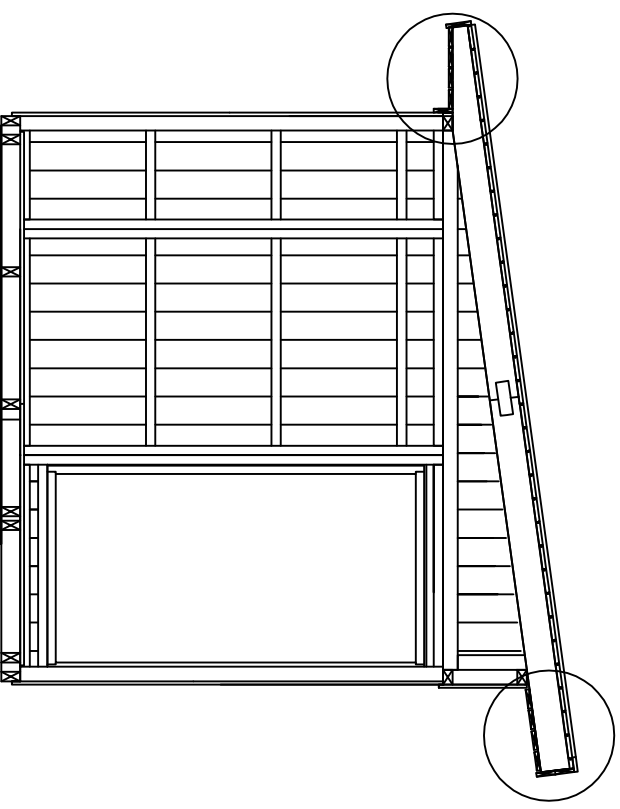
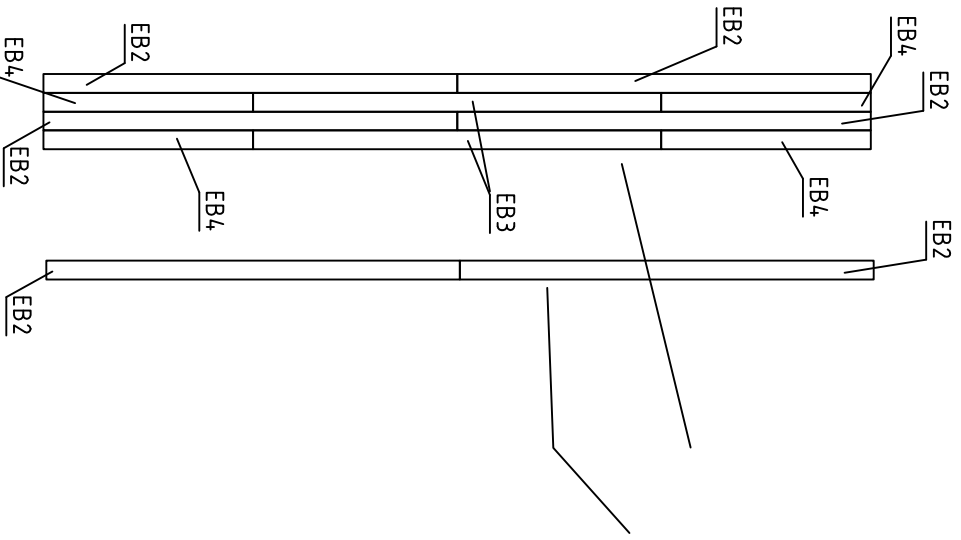

Date rev. Description

House	EL Julian	Sheet	1A
Drawing	Eave boards view	Scale	1:35
Material		Date	25.03.2021
Drawer	K.K.	File	EL Julian.dwg

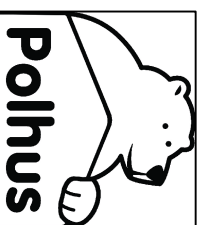

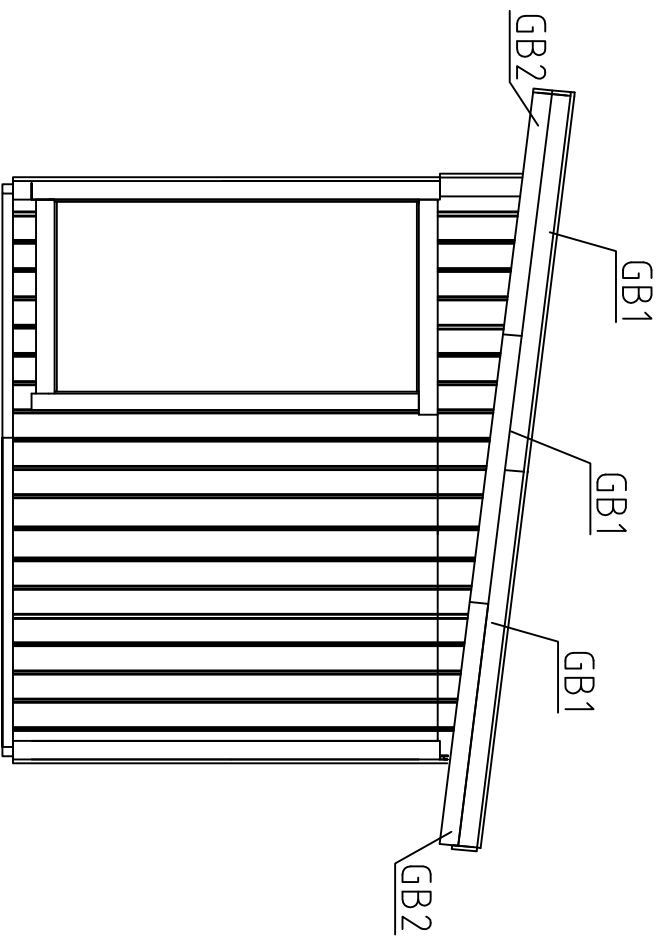

Date      rev.      Description

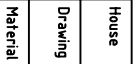
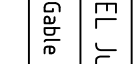
		House	EL Julian	Sheet	1B
		Drawing	Gable boards view	Scale	1:35
		Material		Date	25.03.2021
Drawer	K.K.	File	EL Julian.dwg		

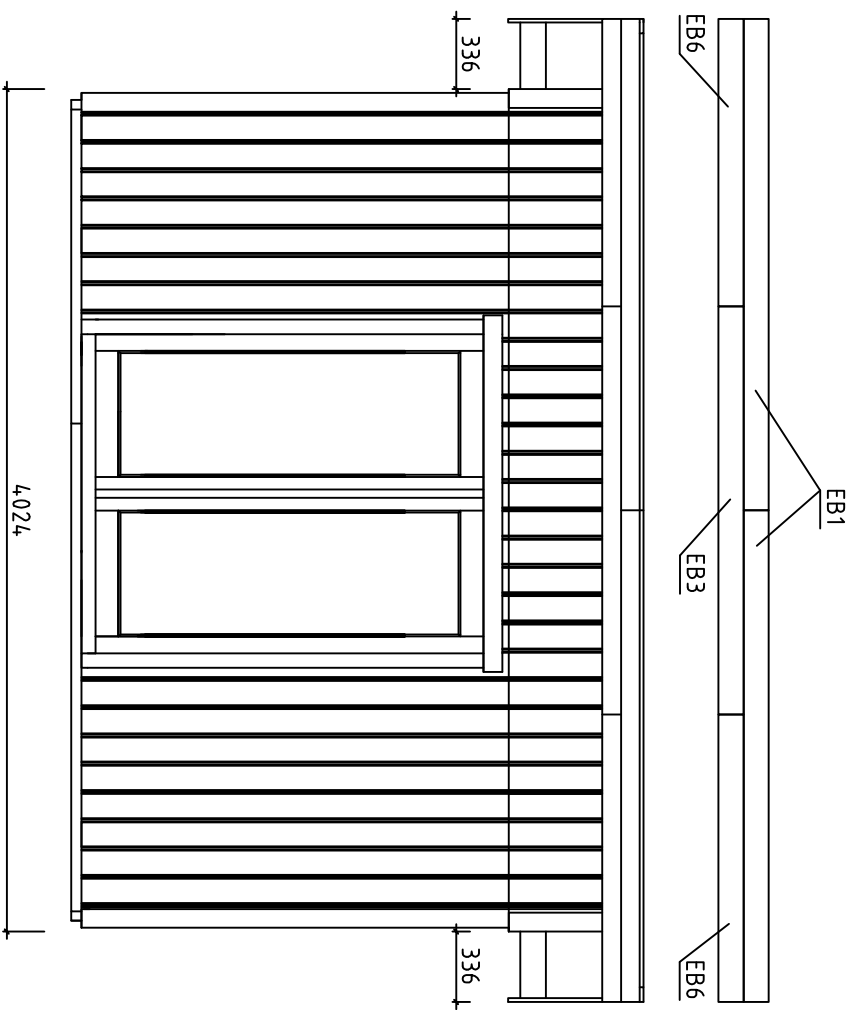

Date rev. Description

 <b>Polhus</b>			
House	EL Julian	Sheet	1C
Drawing	Eave boards view	Scale	1:35
Material		Date	25.03.2021
Drawer	K.K.	File	EL Julian.dwg

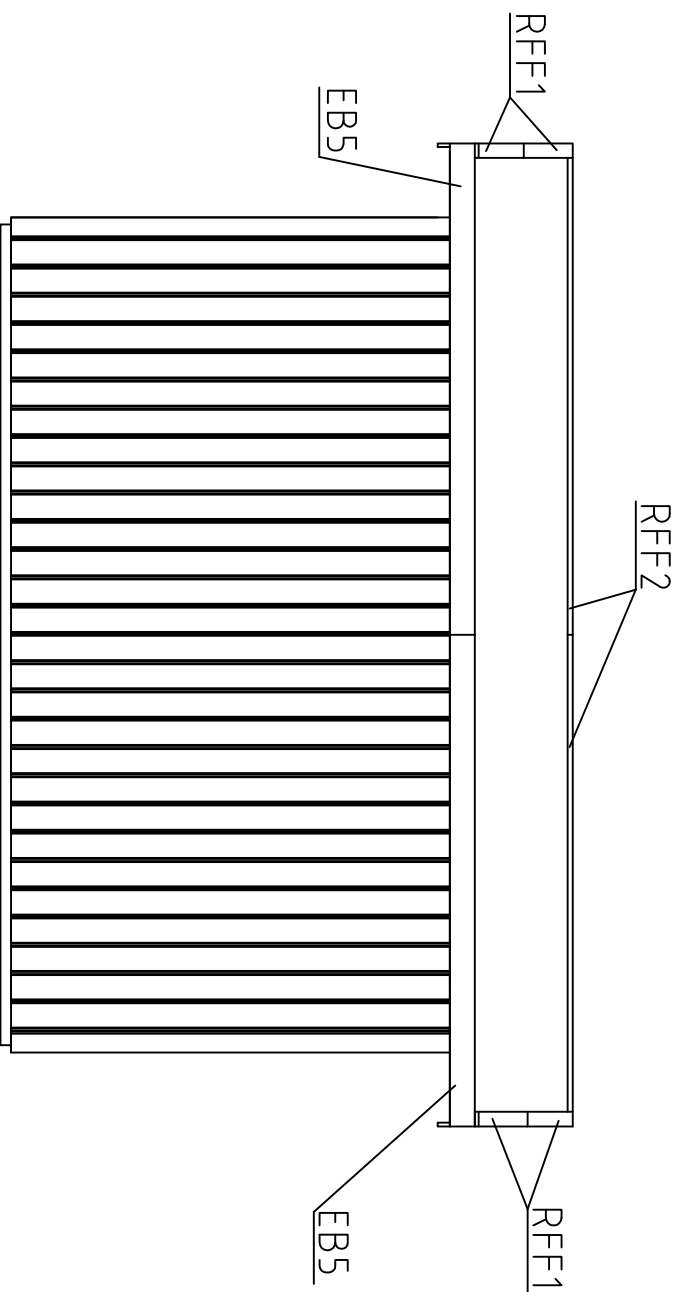

Date      rev.      Description

		House	EL Julian	Sheet	1D
		Drawing	Eave boards view	Scale	1:35
		Material		Date	25.03.2021
Drawer	K.K.	File	EL Julian.dwg		

# Overview description of the manual - Översikts beskrivning för montering - Kokoonpano - ohjeiden kuvaminen

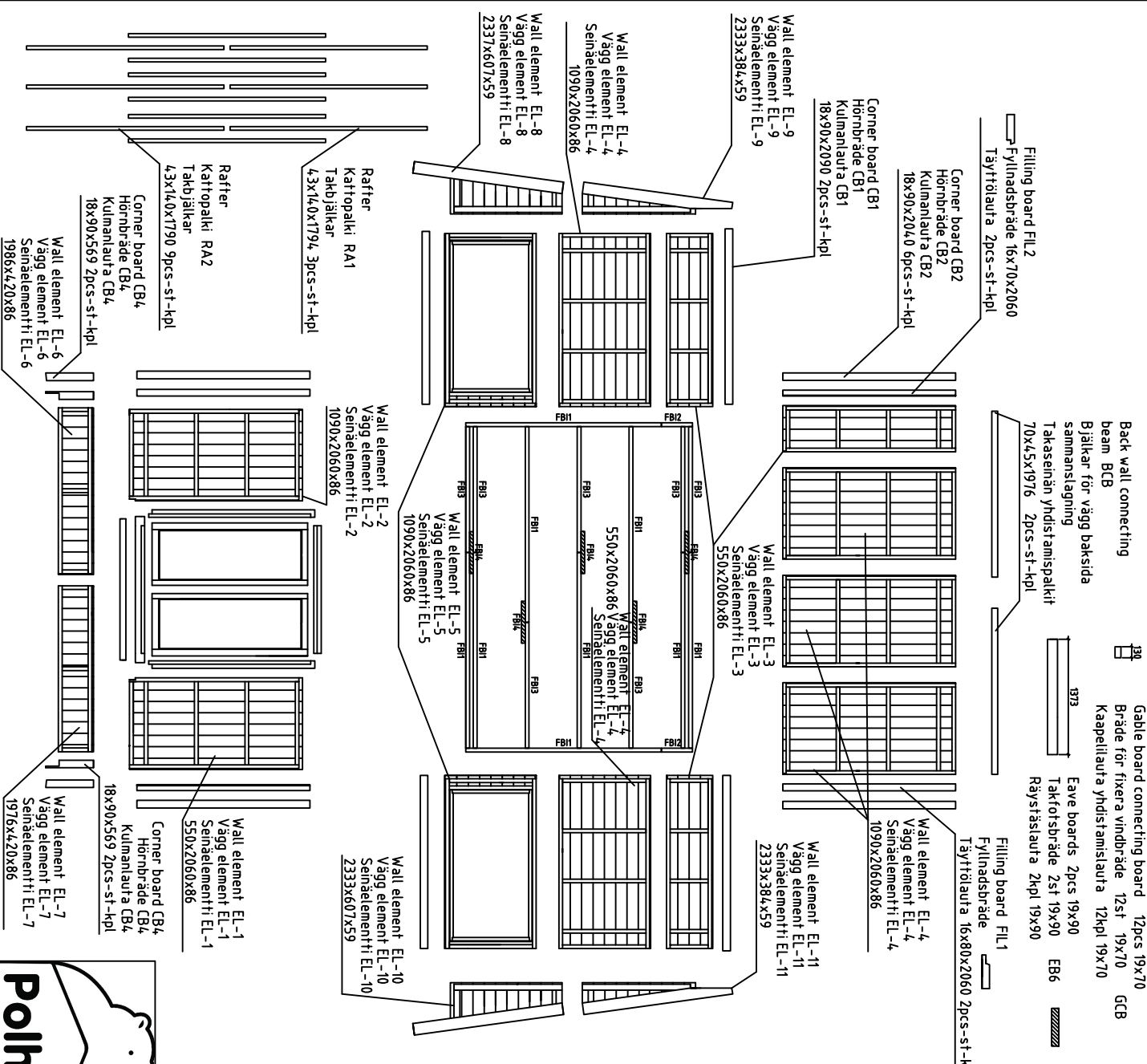

2330	1930	1950	1976	1990	2280	2348	1976	1990	2348	1976	1990	2348
Roofboard 34pcs (18x114) or 454pcs (18x88)	Takbräde 34st (18x114) och 454st (18x88)	Katrollautu 34kpl (18x114) tai 45kpl (18x88)	Takbräde 34st (18x114) och 454st (18x88)	Katrollautu 34kpl (18x114) tai 45kpl (18x88)	Roof felt fillet 2pcs 18x70	Bräde ovanpå gavvelbräde 2st 18x70	Räystäslautu 2st 18x90	Eave boards 10pcs 18x90	Takförsbräde 10st 18x90	Räystäslautu 10kpl 18x90	Eave boards 5pcs 18x90	Takförsbräde 5st 18x90
Takbräde 34st (18x114) tai 45kpl (18x88)	Katrollautu 34kpl (18x114) tai 23kpl (18x88)	Takbräde 17st (18x114) och 23st (18x88)	Katrollautu 17kpl (18x114) tai 23kpl (18x88)	Roofboard 34pcs (18x114) or 454pcs (18x88)	Takbräde 34st (18x114) och 454st (18x88)	Katrollautu 34kpl (18x114) tai 45kpl (18x88)	Takbräde 34st (18x114) och 454st (18x88)	Katrollautu 34kpl (18x114) tai 43kpl (18x88)	Floorboard 34pcs (18x114) or 43pcs (18x88)	Gölvbräde 34st (18x114) och 43st (18x88)	Lattiallauta 34kpl (18x114) tai 43kpl (18x88)	Floor filler 8pcs 18x35
R1	R2	R3	R4	R5	R6	R7	R8	R9	R10	R11	R12	R13
Roofboard 34pcs (18x114) or 454pcs (18x88)	Takbräde 34st (18x114) tai 23st (18x88)	Katrollautu 34kpl (18x114) tai 45kpl (18x88)	Takbräde 34st (18x114) och 454st (18x88)	Katrollautu 34kpl (18x114) tai 45kpl (18x88)	Roof felt fillet 4pcs 18x70	Takbräde för vindbräde 4st 18x70	Katrollautu 4kpl 18x70	Roof felt fillet 4pcs 18x70	Katrollautu 4kpl 18x90	Gavelbräde 4st 18x90	Gavelbräde 4st 18x90	Gavelbräde 4st 18x90
R14	R15	R16	R17	R18	R19	R20	R21	R22	R23	R24	R25	R26
Roofboard 34pcs (18x114) or 454pcs (18x88)	Takbräde 34st (18x114) tai 23st (18x88)	Katrollautu 34kpl (18x114) tai 45kpl (18x88)	Takbräde 34st (18x114) och 454st (18x88)	Katrollautu 34kpl (18x114) tai 45kpl (18x88)	Roof felt fillet 4pcs 18x70	Takbräde för vindbräde 4st 18x70	Katrollautu 4kpl 18x70	Roof felt fillet 4pcs 18x70	Katrollautu 4kpl 18x90	Gavelbräde 4st 18x90	Gavelbräde 4st 18x90	Gavelbräde 4st 18x90
R27	R28	R29	R30	R31	R32	R33	R34	R35	R36	R37	R38	R39
Roofboard 34pcs (18x114) or 454pcs (18x88)	Takbräde 34st (18x114) tai 23st (18x88)	Katrollautu 34kpl (18x114) tai 45kpl (18x88)	Takbräde 34st (18x114) och 454st (18x88)	Katrollautu 34kpl (18x114) tai 45kpl (18x88)	Roof felt fillet 4pcs 18x70	Takbräde för vindbräde 4st 18x70	Katrollautu 4kpl 18x70	Roof felt fillet 4pcs 18x70	Katrollautu 4kpl 18x90	Gavelbräde 4st 18x90	Gavelbräde 4st 18x90	Gavelbräde 4st 18x90
R42	R43	R44	R45	R46	R47	R48	R49	R50	R51	R52	R53	R54
Roofboard 34pcs (18x114) or 454pcs (18x88)	Takbräde 34st (18x114) tai 23st (18x88)	Katrollautu 34kpl (18x114) tai 45kpl (18x88)	Takbräde 34st (18x114) och 454st (18x88)	Katrollautu 34kpl (18x114) tai 45kpl (18x88)	Roof felt fillet 4pcs 18x70	Takbräde för vindbräde 4st 18x70	Katrollautu 4kpl 18x70	Roof felt fillet 4pcs 18x70	Katrollautu 4kpl 18x90	Gavelbräde 4st 18x90	Gavelbräde 4st 18x90	Gavelbräde 4st 18x90
R59	R60	R61	R62	R63	R64	R65	R66	R67	R68	R69	R70	R71
Roofboard 34pcs (18x114) or 454pcs (18x88)	Takbräde 34st (18x114) tai 23st (18x88)	Katrollautu 34kpl (18x114) tai 45kpl (18x88)	Takbräde 34st (18x114) och 454st (18x88)	Katrollautu 34kpl (18x114) tai 45kpl (18x88)	Roof felt fillet 4pcs 18x70	Takbräde för vindbräde 4st 18x70	Katrollautu 4kpl 18x70	Roof felt fillet 4pcs 18x70	Katrollautu 4kpl 18x90	Gavelbräde 4st 18x90	Gavelbräde 4st 18x90	Gavelbräde 4st 18x90
R76	R77	R78	R79	R80	R81	R82	R83	R84	R85	R86	R87	R88
Roofboard 34pcs (18x114) or 454pcs (18x88)	Takbräde 34st (18x114) tai 23st (18x88)	Katrollautu 34kpl (18x114) tai 45kpl (18x88)	Takbräde 34st (18x114) och 454st (18x88)	Katrollautu 34kpl (18x114) tai 45kpl (18x88)	Roof felt fillet 4pcs 18x70	Takbräde för vindbräde 4st 18x70	Katrollautu 4kpl 18x70	Roof felt fillet 4pcs 18x70	Katrollautu 4kpl 18x90	Gavelbräde 4st 18x90	Gavelbräde 4st 18x90	Gavelbräde 4st 18x90
R95	R96	R97	R98	R99	R100							

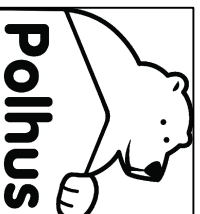

House	EL Julian	Sheet	2
Drawing		Scale	1:35
Material		Date	25.03.2021
Drawer	K.K.	File	EL Julian.dwg

Date rev. Description

# Installation of floorbeams and floorboards - montering av golvbjälkar samt golvbrädor - lattiapalkien ja lattialautojen asennus

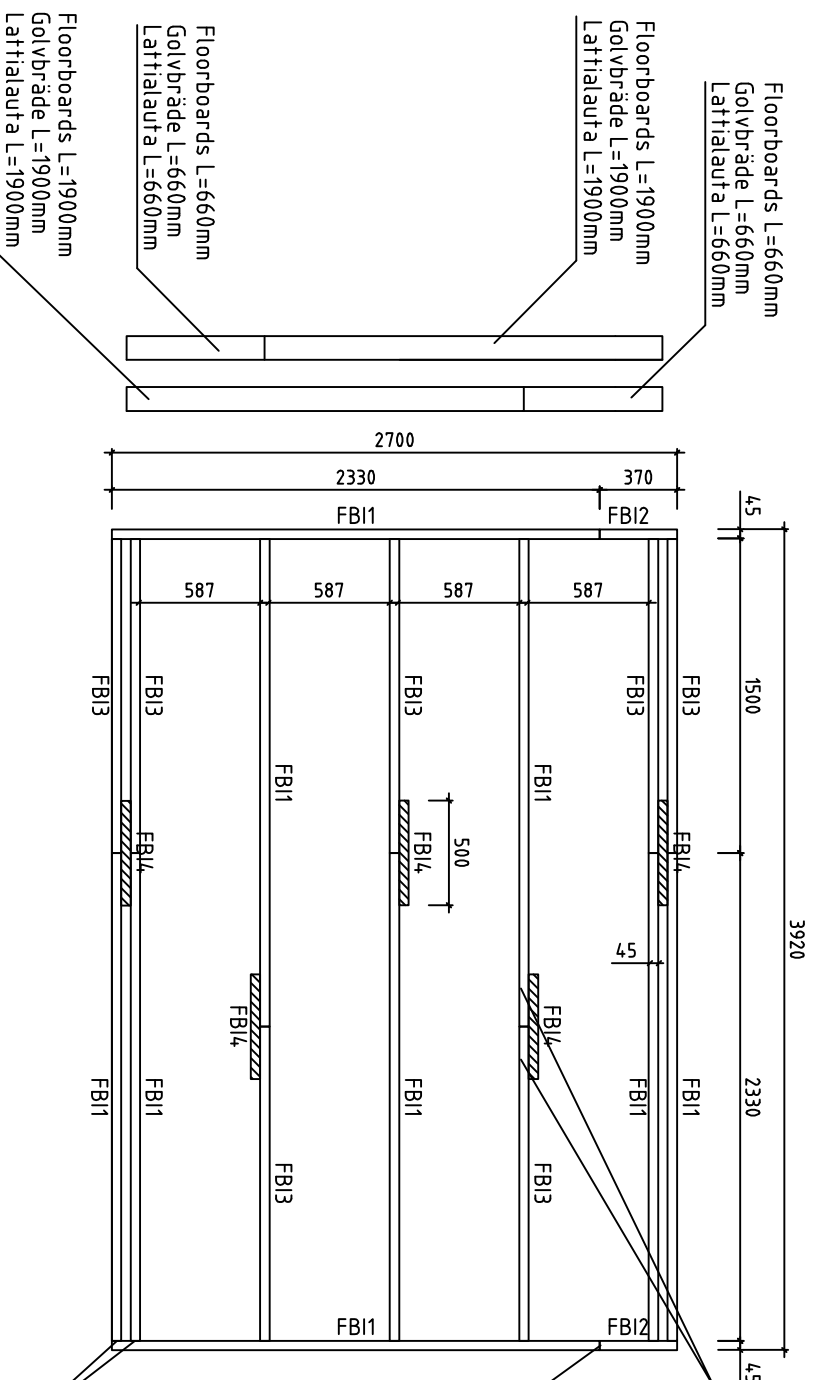

Connect with screws 4.5x70  
 Skruvas samman med skruvar 4.5x70  
 Kiinnitetään ruuveilla 4.5x70

Connect with metal plate 60x160+screws 4.5x4.5 8pcs  
 Skarvas med metall platta 60x160+skruvar 4.5x4.5 8st  
 Liitetään metallilevyillä 60x160+ruuvit 4.5x4.5 8kpl

Connect with screws 4.5x70  
 Skruvas samman med skruvar 4.5x70  
 Kiinnitetään ruuveilla 4.5x70

- NB!!! Change the floorboard positions after every row
- NB!!! Skarva golvbrädorna olika efter varje rad
- NB!!! Muuta lattialautojen sijaintia jokaisen rivin jälkeen



House	EL Julian	Sheet	3
Drawing	Floorbeams-lattiapalkit-golvbjälkar	Scale	1:35
Material	4.5x90	Date	25.03.2021
Drawer	K.K.	File	EL Julian.dwg

Installation of wall element EL-1, EL-2 - montering av vägg element EL-1, EL-2 - seinäelementin EL-1, EL-2 asennus  
(Front wall - vägg framsida - etuseinä)

View from inside - Från insidan - Näkymä sisältä

Wall element EL-1  
Vägg element EL-1  
Seinäelementti EL-1

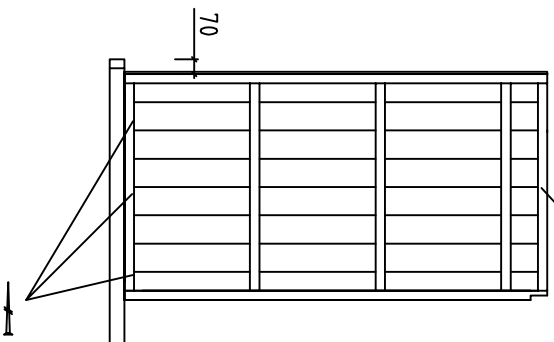

Wall element EL-2  
Vägg element EL-2  
Seinäelementti EL-2

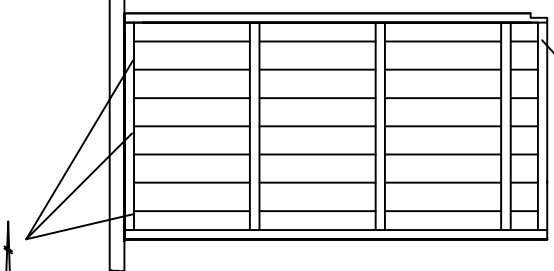

Wall element EL-1  
Vägg element EL-1  
Seinäelementti EL-1

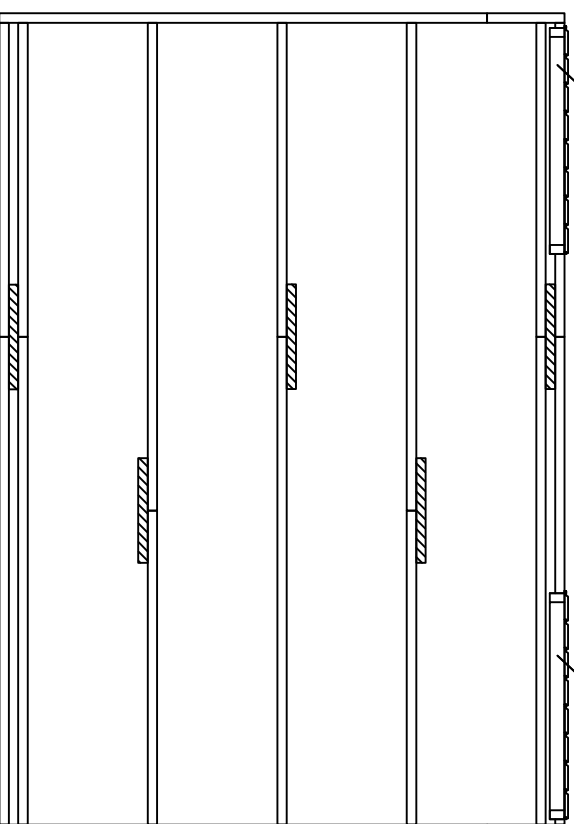

Wall element EL-2  
Vägg element EL-2  
Seinäelementti EL-2

Fix wall element EL-1, EL-2 with screws

4.5x70 into floorbeam

Fixera vägg element EL-1, EL-2 med skruvar

4.5x70 i golvbjälke

Kiinnitä seinäelementti EL-1, EL-2 ruuvilla

4.5x70 lattiapalkkin

Date rev. Description

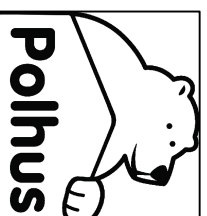

House	EL Julian	Sheet	4
Drawing		Scale	1:35
Material		Date	25.03.2021
Drawer	K.K.	File	EL Julian.dwg



Installation of wall element EL-3, EL-4, EL-5 - montering av vägg element EL-3, EL-4, EL-5 - seinäelementin EL-3, EL-4, EL-5 asennus  
(Front wall - vägg framsida - etuseinä)

View from inside - Från insidan - Näkymä sisältä

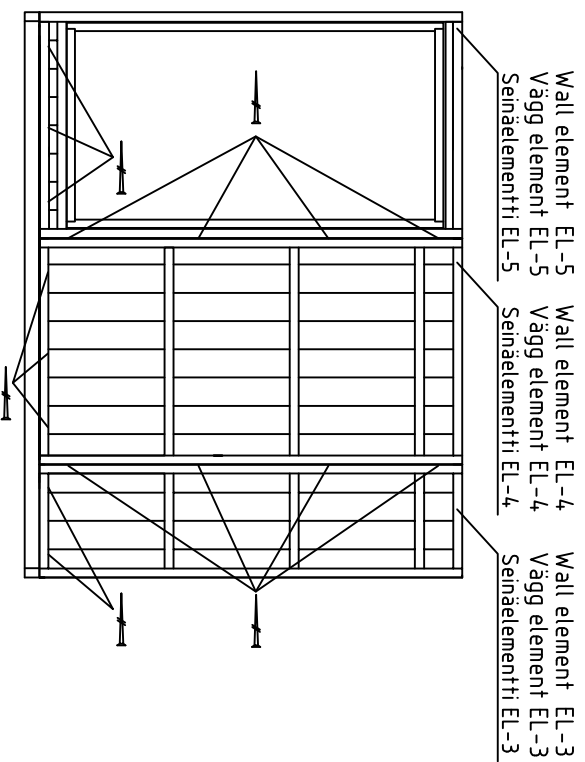

- Fix wall element EL-3, EL-4, EL-5 with screws
- 4.5x70 into floorbeam
- Fixera vägg element EL-3, EL-4, EL-5 med skruvar
- 4.5x70 i golvbjälke
- Kiinnitä seinäelementti EL-3, EL-4, EL-5 ruuveilla
- 4.5x70 lattiapalkkin
- Fix wall elements EL-3, EL-4, EL-5 with screws
- 4.5x70 together
- Fixera vägg element EL-3, EL-4, EL-5 med skruvar
- 4.5x70 tillsammans
- Kiinnitä seinäelementit EL-3, EL-4, EL-5
- yhteen ruuveilla 4.5x70

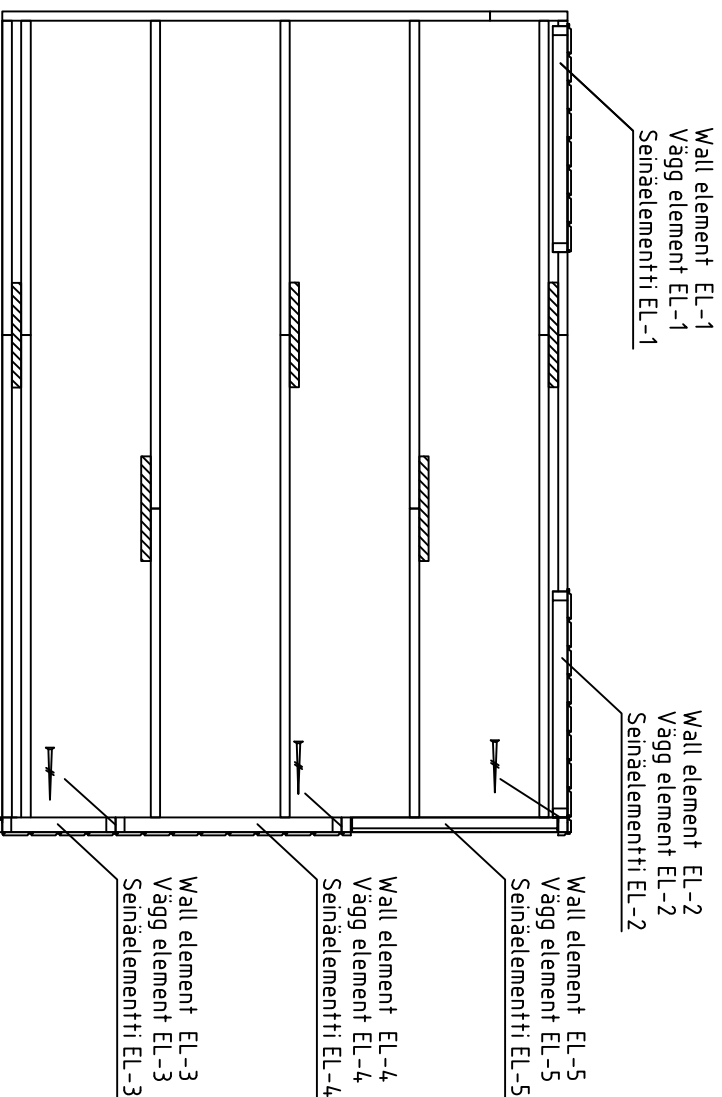

Date rev. Description

	House	EL Julian	Sheet	5
	Drawing		Scale	1:35
Material		Date	25.03.2021	
Drawer	K.K.		File	EL Julian.dwg

Installation of wall element EL-3, 3xEL-4 - montering av vägg element EL-3, 3xEL-4 - seinäelementin EL-3, 3xEL-4 asennus  
(Front wall - vägg framsida - etuseinä)

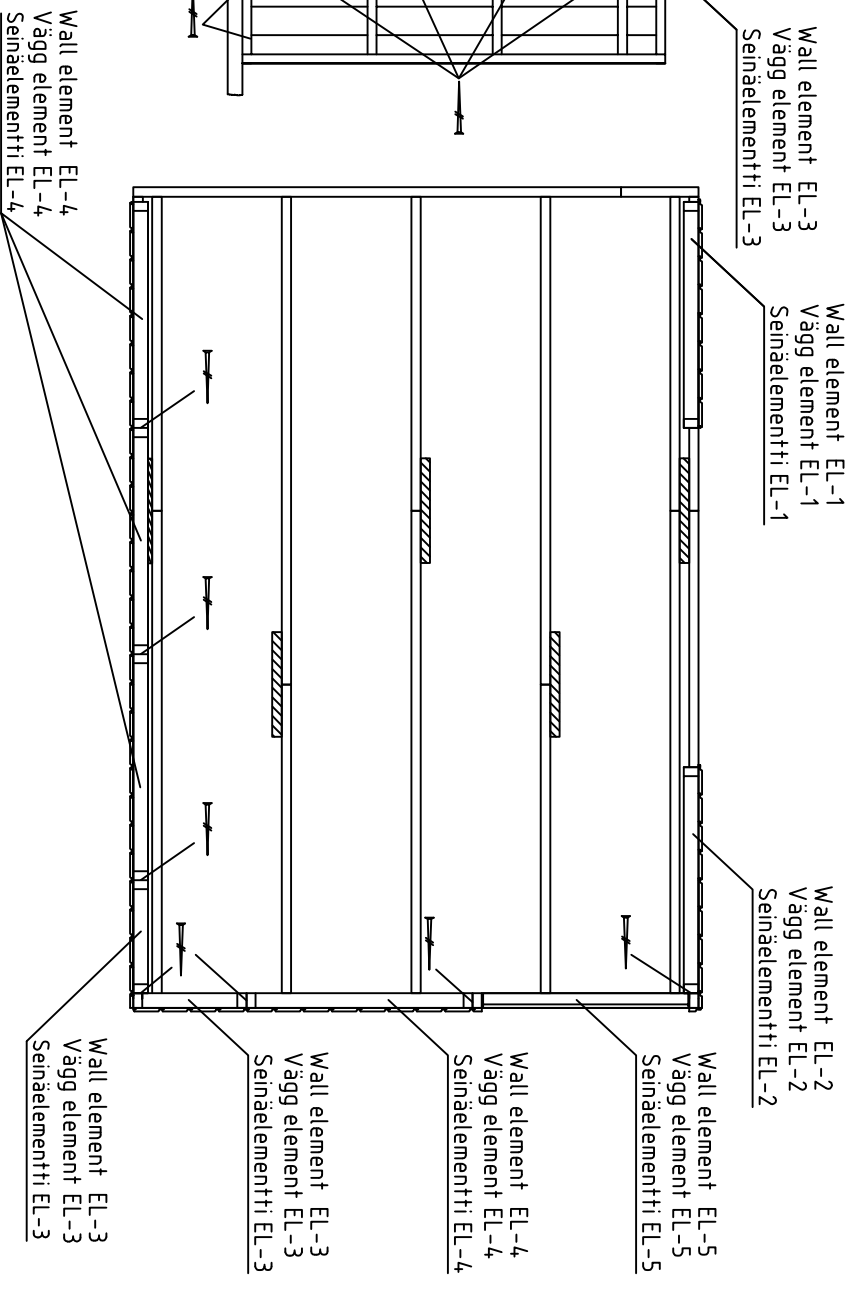
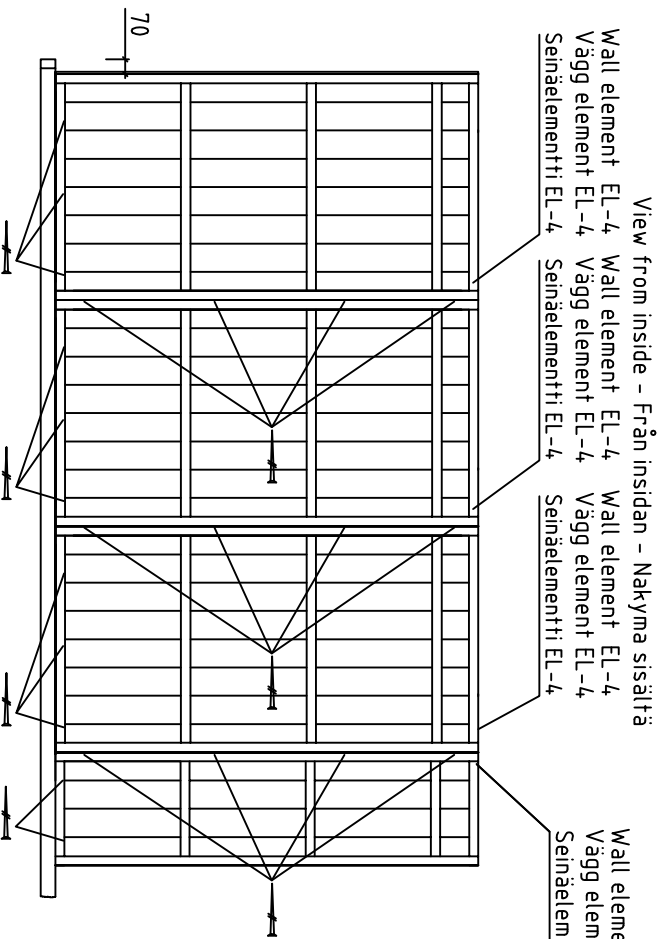

- Fix wall element EL-3, 3xEL-4 with screws  
4.5x70 into floorbeam  
Fixera vägg element EL-3, 3xEL-4 med skruvar  
4.5x70 i golvbjälke
- Kiinnitä seinäelementti EL-3, 3xEL-4 ruuveilla  
4.5x70 lattiapalkkin
- Fix wall elements EL-3, 3xEL-4 with screws  
4.5x70 together  
Fixera vägg element EL-3, 3xEL-4 med skruvar  
4.5x70 tillsammans
- Kiinnitä seinäelementit EL-3, 3xEL-4  
yhteen ruuveilla 4.5x70

Date rev. Description

	House	EL Julian	Sheet	6
	Drawing		Scale	1:35
	Material		Date	27.01.2016
	Drawer	K.K.	File	EL Julian.dwg

Installation of wall element EL-3, EL-4, EL-5 – montering av vägg element EL-3, EL-4, EL-5 – seinäelementin EL-3, EL-4, EL-5 asennus  
(Front wall – vägg framsida – etuseinä)

View from inside – Från insidan – Näkymä sisältä

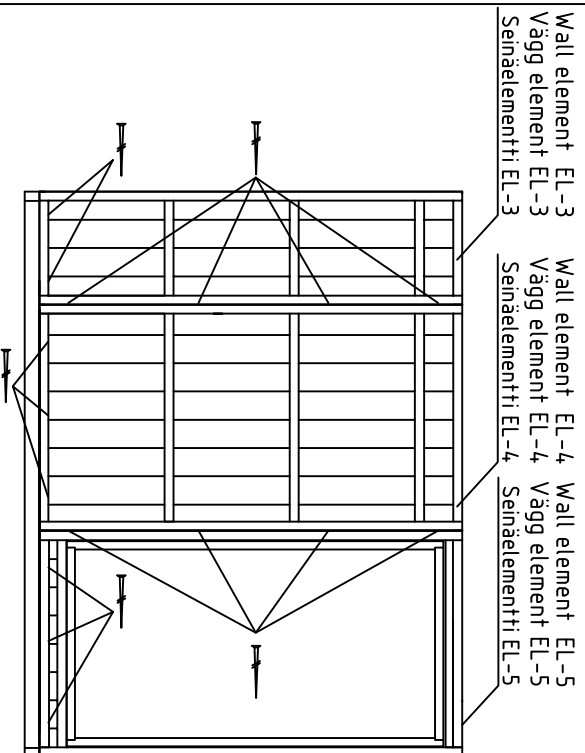

Wall element EL-5  
Vägg element EL-5  
Seinäelementti EL-5

Wall element EL-4  
Vägg element EL-4  
Seinäelementti EL-4

Wall element EL-3  
Vägg element EL-3  
Seinäelementti EL-3

Wall element EL-4  
Vägg element EL-4  
Seinäelementti EL-4

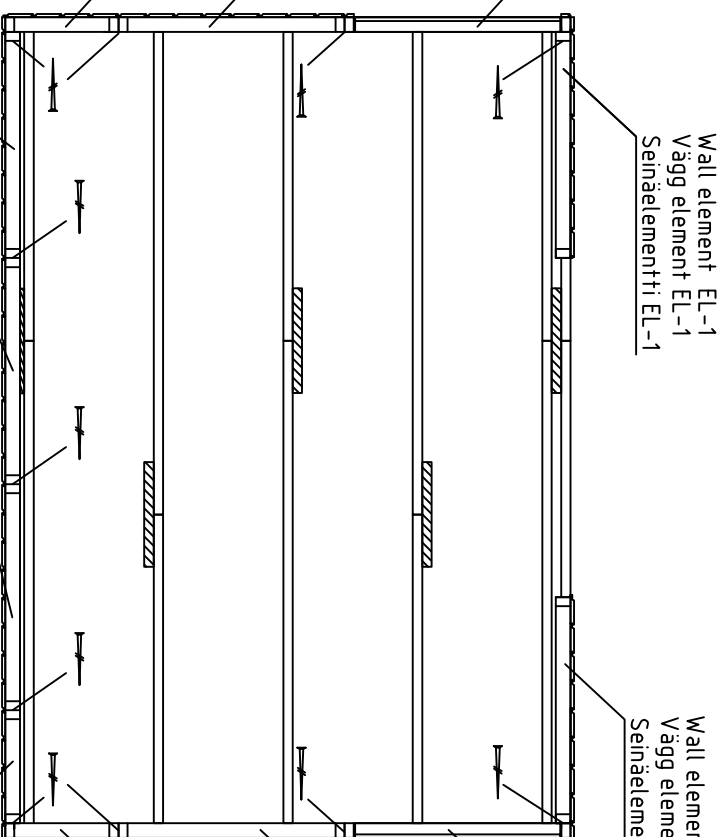

Wall element EL-1  
Vägg element EL-1  
Seinäelementti EL-1

Wall element EL-2  
Vägg element EL-2  
Seinäelementti EL-2

Wall element EL-5  
Vägg element EL-5  
Seinäelementti EL-5

Wall element EL-4  
Vägg element EL-4  
Seinäelementti EL-4

Wall element EL-3  
Vägg element EL-3  
Seinäelementti EL-3

Wall element EL-3  
Vägg element EL-3  
Seinäelementti EL-3

Fix wall element EL-3, EL-4, EL-5 with screws

4.5x70 into floorbeam

Fixera vägg element EL-3, EL-4, EL-5 med skruvar

4.5x70 i golvbjälke

Kiinnitä seinäelementti EL-3, EL-4, EL-5 ruuveilla

4.5x70 lattiapalkkin

Fix wall elements EL-1, EL-3, 2xEL-4, EL-5 with screws

4.5x70 together

Fixera vägg element EL-1, EL-3, 2xEL-4, EL-5 med skruvar

4.5x70 tillsammans

Kiinnitä seinäelementit EL-1, EL-3, 2xEL-4, EL-5

yhteen ruuveilla 4.5x70

Date rev. Description

	House	EL Julian	Sheet	7
	Drawing		Scale	1:35
	Material		Date	25.03.2021
	Drawer	K.K.	File	EL Julian.dwg

Installation of back wall connecting beams - montering av bjälkar för vägg baksida sammanslagning - takaseinän yhdistämispalkit asennus

Screws 4.5x70 4pcs  
 Skruvar 4.5x70 4st  
 Ruuvit 4.5x70 4kpl

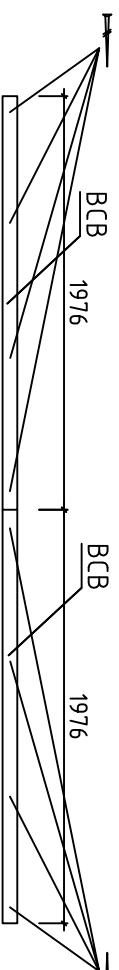

Screws 4.5x70 4pcs  
 Skruvar 4.5x70 4st  
 Ruuvit 4.5x70 4kpl

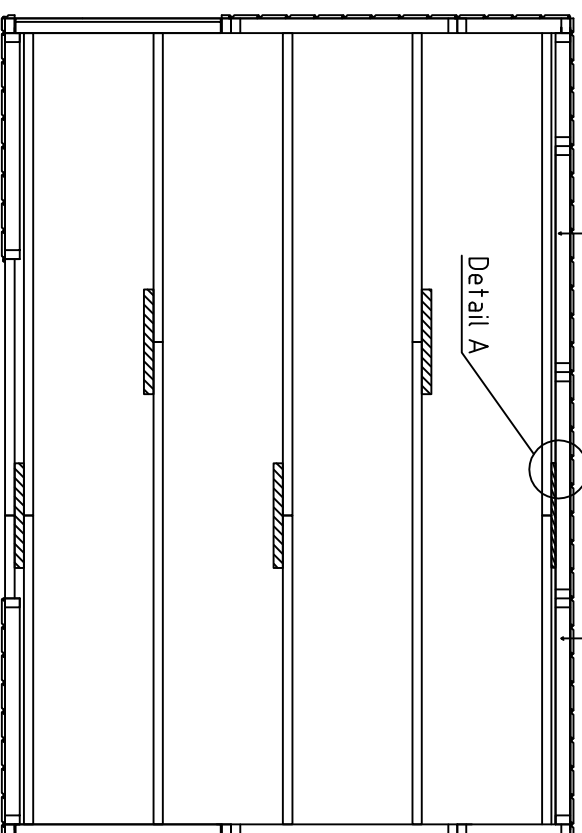

Screws 4.5x70  
 Skruvar 4.5x70  
 Ruuvit 4.5x70

Detail A

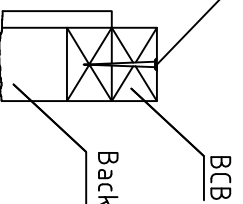

Back wall-vägg baksida-takaseinä

Date rev. Description

House	EL Julian	Sheet	8
Drawing		Scale	1:35
Material		Date	25.03.2021
Drawer	K.K.	File	EL Julian.dwg

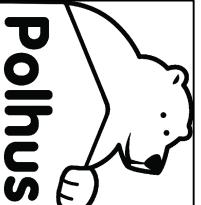

Installation of wall element EL-7 and EL-8 – montering av vägg element EL-7 och EL-8 –seinäelementin EL-7 ja EL-8 asennus  
(Front wall – vägg framsida – etuseinä)

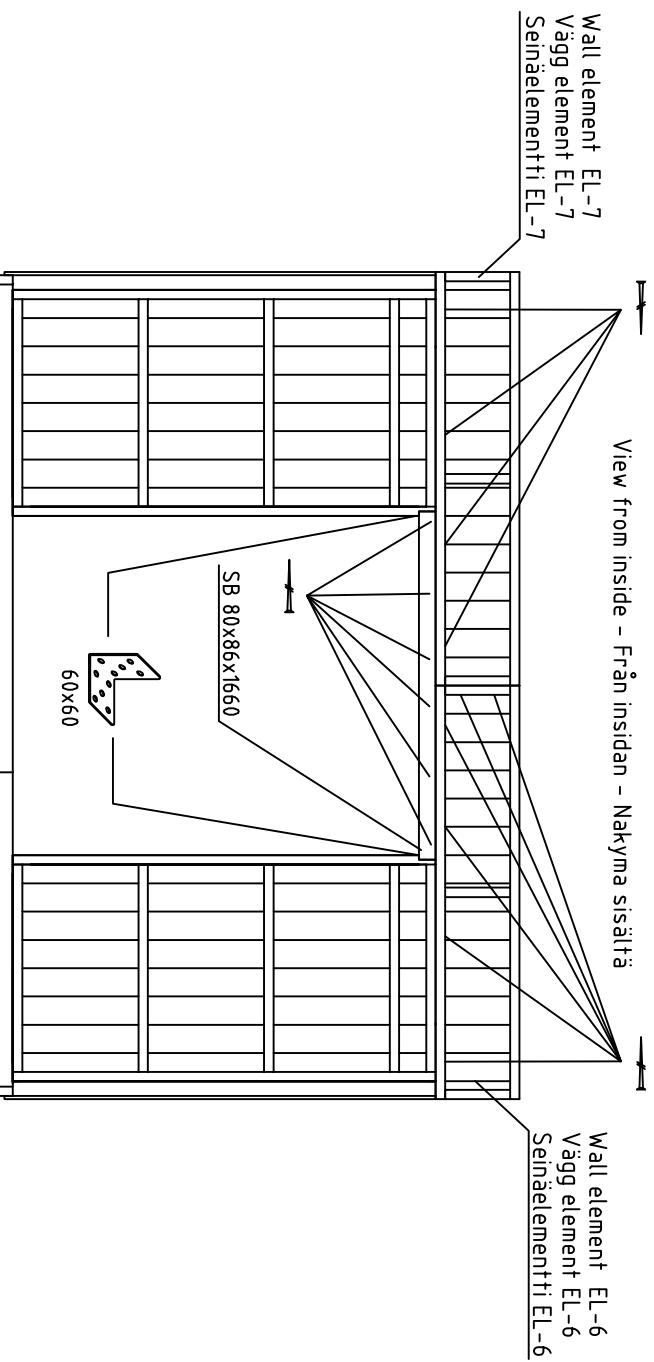

Fix wall element EL-7 with front wall elements with screws 4.5x70 together

Fixera vägg element EL-7 med elementat vägg framsida med skruvar 4.5x70 tillsammans

Kiinnitä seinäelementti EL-7 yhteen etuseinän elementit ruuveilla 4.5x70

Fix wall element EL-8 to front wall elements with screws 4.5x70 together

Fixera vägg element EL-8 med elementat vägg framsida med skruvar 4.5x70 tillsammans

Kiinnitä seinäelementti EL-8 yhteen etuseinä elementit ruuveilla 4.5x70

Fix wall elements EL-7 and EL-8 with screws 4.5x70 together

Fixera vägg element EL-7 och EL-8 med skruvar 4.5x70 tillsammans

Kiinnitä seinäelementit EL-7 ja EL-8 yhteen ruuveilla 4.5x70

Date rev. Description

House	EL Julian	Sheet	9
Drawing		Scale	1:35
Material		Date	25.03.2021
Drawer	K.K.	File	EL Julian.dwg

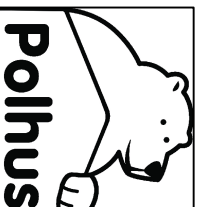

Installation of wall element EL-8 and EL-9 - montering av vägg element EL-8 och EL-9 -seinäelementin EL-8 ja EL-9 asennus

(Left sidewall - vänster sidovägg - vasen sivuseinä)

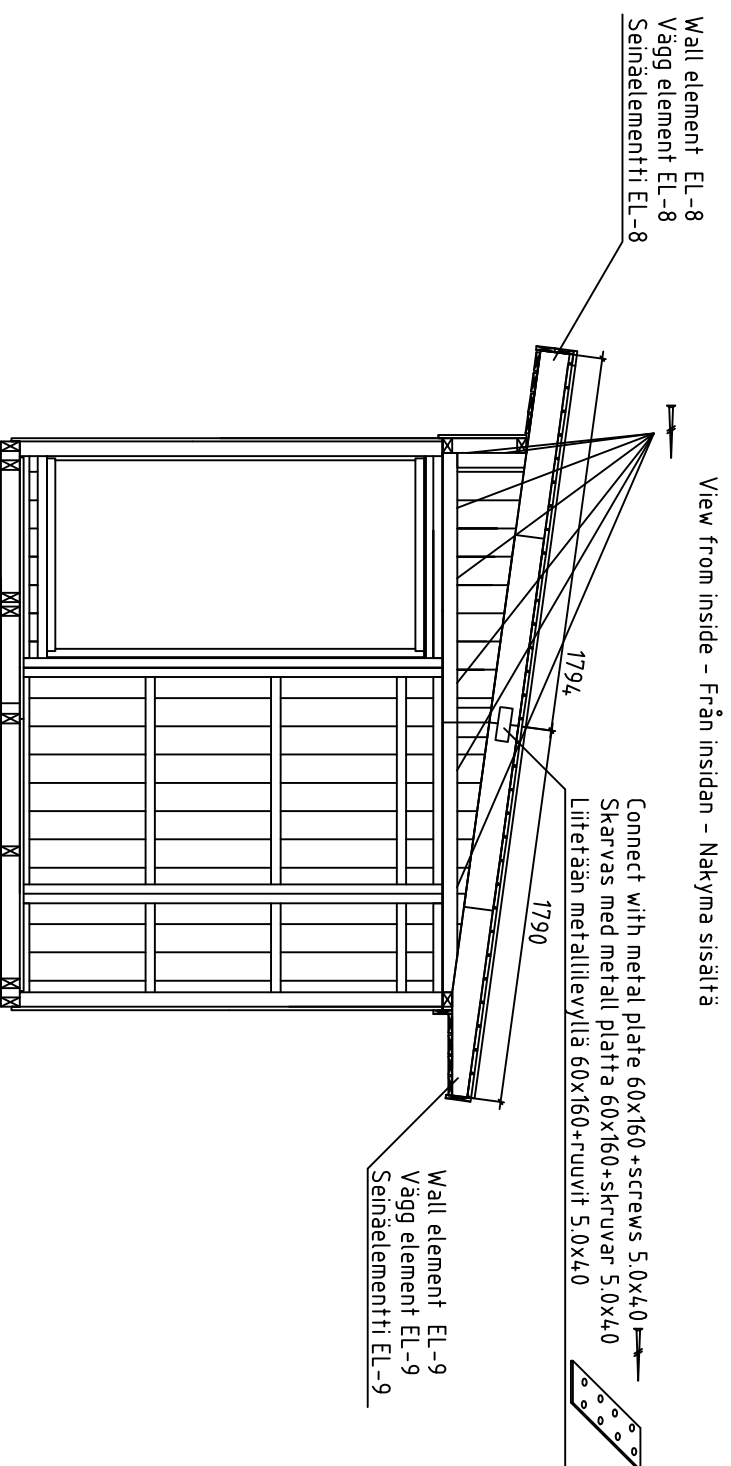

Fix wall element EL-8 with left sidewall elements with screws 5.0x120 together

Fixera vägg element EL-8 med elementat vänster sidovägg med skruvar 5.0x120 tillsammans

Kiinnitä seinäelementti EL-8 yhteen vasen sivuseinä elementit ruuveilla 5.0x120

Fix wall elements EL-8 and EL-5 with screws 5.0x120 together

Fixera vägg element EL-8 och EL-5 med skruvar 5.0x120 tillsammans

Kiinnitä seinäelementit EL-8 ja EL-5 yhteen ruuveilla 5.0x120

Fix wall element EL-9 with left sidewall elements with screws 5.0x120 together

Fixera vägg element EL-9 med elementat vänster sidovägg med skruvar 5.0x120 tillsammans

Kiinnitä seinäelementti EL-9 yhteen vasen sivuseinä elementit ruuveilla 5.0x120

Date rev. Description

House	EL Julian	Sheet	10
Drawing		Scale	1:35
Material		Date	27.01.2016
Drawer	K.K.	File	EL Julian.dwg

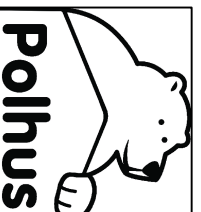

Installation of wall element EL-10 and EL-11 – montering av vägg element EL-10 och EL-11 – seinäelementin EL-10 ja EL-11 asennus  
(Left sidewall – vänster sidovägg – vasen sivuseinä)

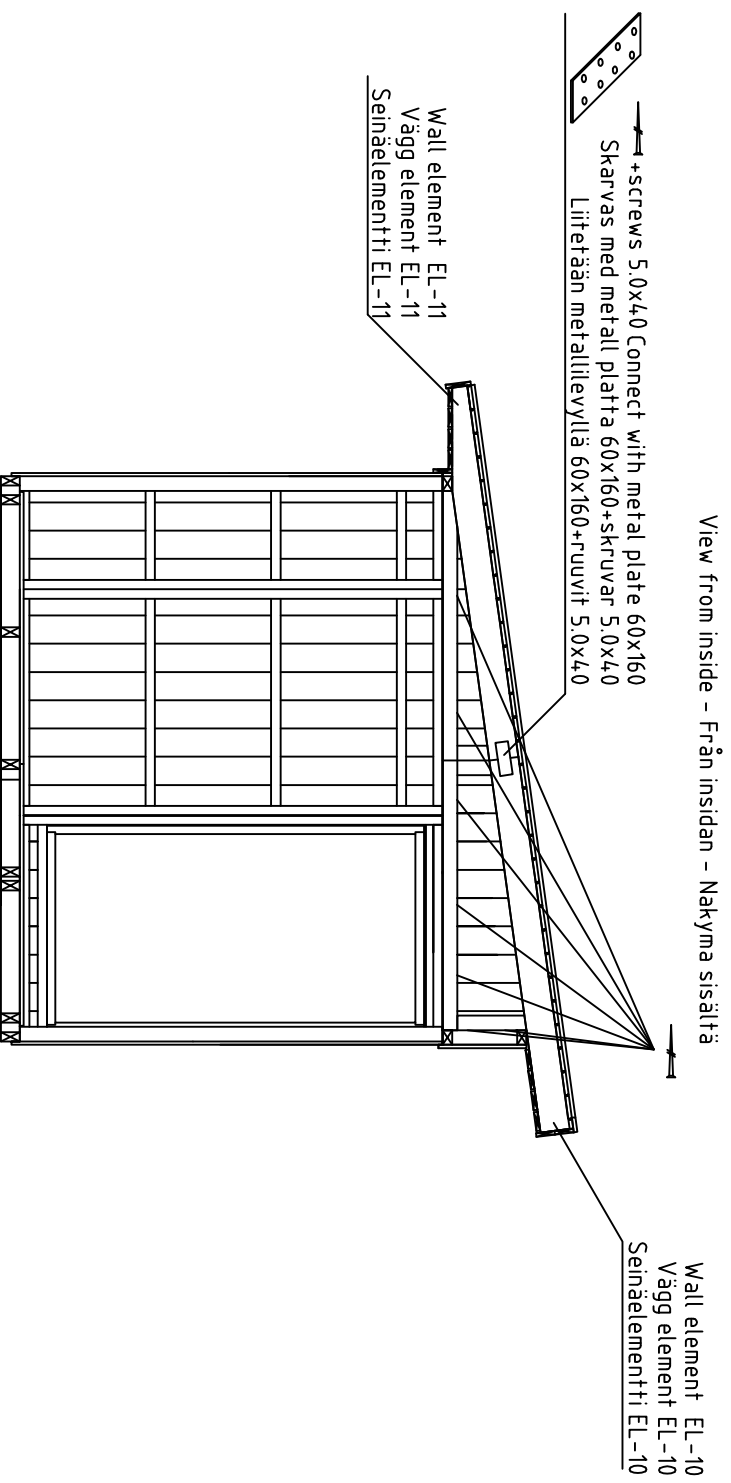

Fix wall element EL-10 with left sidewall elements with screws 5.0x120 together

Fixera vägg element EL-10 med elementat vänster sidovägg med skruvar 5.0x120 tillsammans

Kiinnitä seinäelementti EL-10 yhteen vasen sivuseinä elementit ruuveilla 5.0x120

Fix wall elements EL-10 and EL-5 with screws 5.0x120 together

Fixera vägg element EL-10 och EL-5 med skruvar 5.0x120 tillsammans

Kiinnitä seinäelementit EL-10 ja EL-5 yhteen ruuveilla 5.0x120

Fix wall element EL-11 with left sidewall elements with screws 5.0x120 together

Fixera vägg element EL-11 med elementat vänster sidovägg med skruvar 5.0x120 tillsammans

Kiinnitä seinäelementti EL-11 yhteen vasen sivuseinä elementit ruuveilla 5.0x120

Date rev. Description

House	EL Julian	Sheet	11
Drawing		Scale	1:35
Material		Date	25.03.2021
Drawer	K.K.	File	EL Julian.dwg

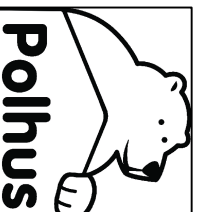

## Roofbeams connecting-montering av takbjälkar-kattopalkki yhdistamine

Connect with nails 5,0x120  
 Fixera med spikar 5,0x120  
 Kiinnitä yhteen naulalla 5,0x120

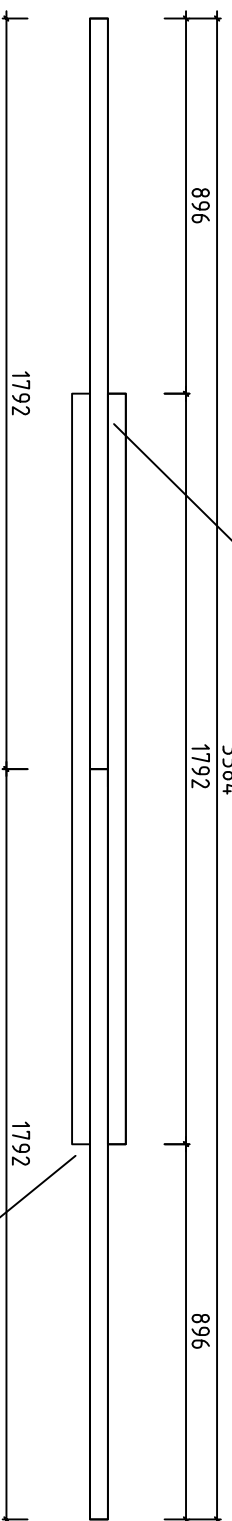

Connect with nails 5,0x120  
 Fixera med spikar 5,0x120  
 Kiinnitä yhteen naulalla 5,0x120

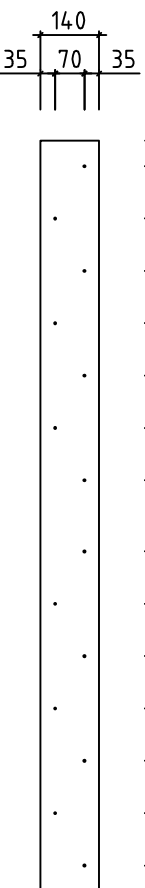
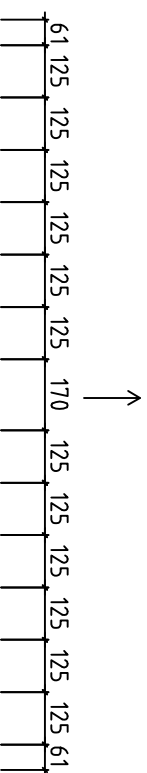

NB!!! Bore holes  $\varnothing$ 5mm before so that on one side and on other side holes dosen't match

NB!!! Skruva från båda sidorna men inte så att dessa möter varandra

Date rev. Description

House	EL Julian	Sheet	12
Drawing	Roofbeams connecting-montering av takbjälkar	Scale	1:35
Material		Date	25.03.2021
Drawer	K.K.	File	EL Julian.dwg

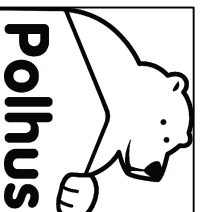



# Ferm install-installera takläggning-kattoparru asennus

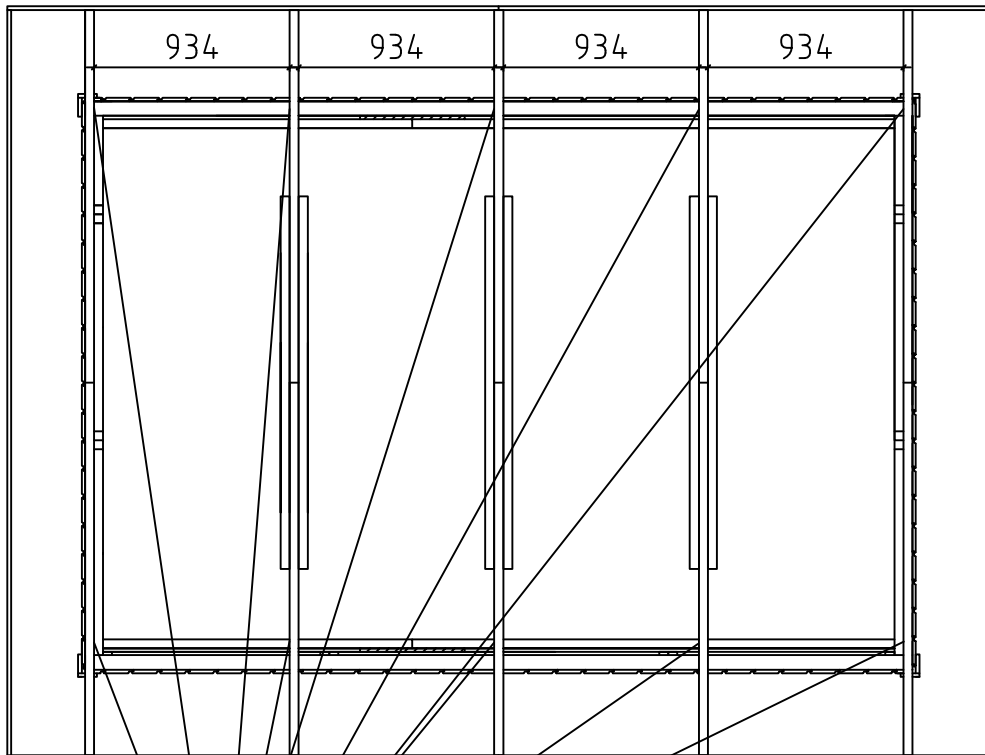
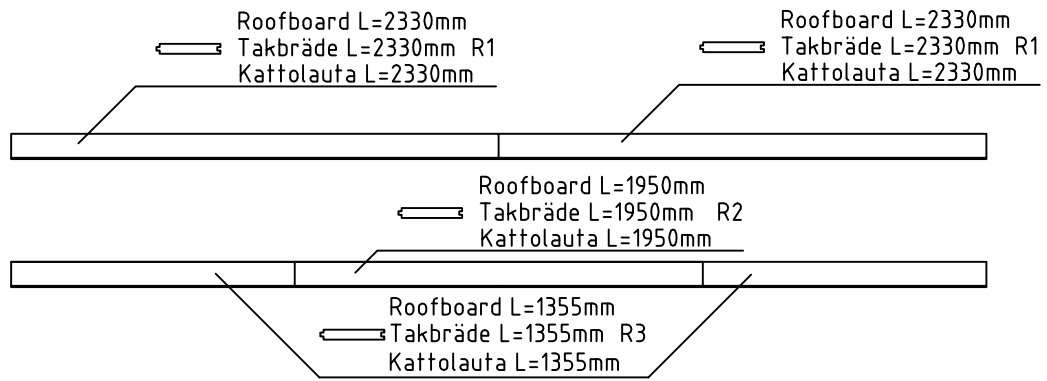

Connect with steel corner 90x90x65+screws 4.5x45 8pcs  
Skarvas med metallvinkel 90x90x65+skruvar 4.5x45 8st  
Liitetään kulmarautaan 90x90x65+ruuvit 4.5x45 8kpl



NB!!! Change the roofboard positions after every row  
NB!!! Skarva tak brädorna olika efter varje rad  
NB!!! Muuta kattolautojen sijaintia jokaisen rivin jälkeen

Date rev. Description



House	EL Julian	Sheet	13
Drawing		Scale	1:35
Material		Date	25.03.2021
Drawer	K.K.	File	EL Julian.dwg

2 PAKKI L<2.35m

Pos

EL Julian

Nr. Profile L  
Pcs. (mm) (mm)

Wall element EL-7 1pc  
Vägg element EL-7 1st  
Seinäelementti EL-7 1kpl  
1976x420x86

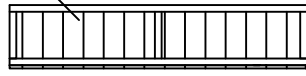

Wall element EL-6 1pc  
Vägg element EL-6 1st  
Seinäelementti EL-6 1kpl  
1986x420x86

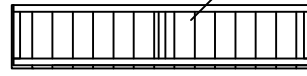

Wall element EL-3 3pcs  
Vägg element EL-3 3st  
Seinäelementti EL-3 3kpl  
550x2060x86

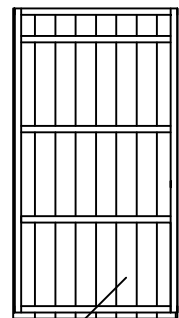
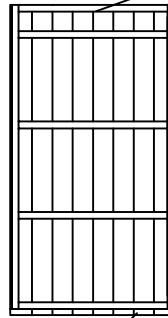
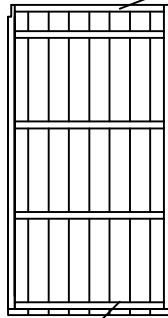
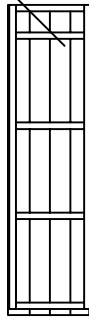

WS-1

Wall element EL-2 1pc  
Vägg element EL-2 1st  
Seinäelementti EL-2 1kpl  
1090x2060x86

Wall element EL-1 1pc  
Vägg element EL-1 1st  
Seinäelementti EL-1 1kpl  
1090x2060x86

Wall element EL-4 5pcs  
Vägg element EL-4 5st  
Seinäelementti EL-4 5kpl  
1090x2060x86

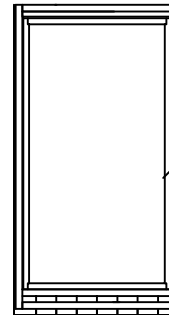

Wall element EL-5 2pc  
Vägg element EL-5 2st  
Seinäelementti EL-5 2kpl  
1090x2060x86

Wall element EL-8 1pc  
Vägg element EL-8 1st  
Seinäelementti EL-8 1kpl  
2337x607x59



Wall element EL-9 1pc  
Vägg element EL-9 1st  
Seinäelementti EL-9 1kpl  
2333x384x59

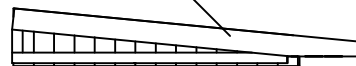

Wall element EL-10 1pc  
Vägg element EL-10 1st  
Seinäelementti EL-10 1kpl  
2333x384x59



Wall element EL-11 1pc  
Vägg element EL-11 1st  
Seinäelementti EL-11 1kpl  
2333x607x59

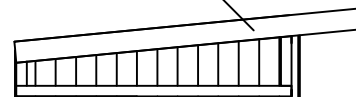

Polhus











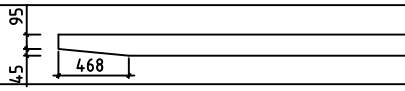
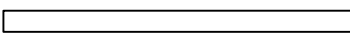
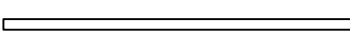

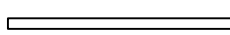

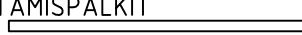











Kood EL Julian

Materiaal

File EL Julian.dwg

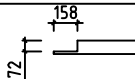
Leht 14

# 2 PAKKI L<2.35m

Pos	EL Julian	Nr. Pcs.	Profile (mm)	L (mm)
RA1	RAFTER - KATTOPALKI - TAKBJÄLKAR 	3	43x140	1794
RA2	RAFTER - KATTOPALKI - TAKBJÄLKAR 	9	43x140	1790
FBI1	FLOORBEAM - LATTIAPALKI - GOLVBJÄLKAR 	9	45x90	2330
FBI2	FLOORBEAM - LATTIAPALKI - GOLVBJÄLKAR 	2	45x90	370
FBI3	FLOORBEAM - LATTIAPALKI - GOLVBJÄLKAR 	7	45x90	1500
FBI4	FLOORBEAM CONNECTING BEAM - LATTIAPALKI YHDISTAMISPALKIT BRÄDE FÖR GOLVBJÄLKAR SAMMANSLAGNING 	5	45x90	500
BCB	BACK WALL CONNECTING BEAM - TAKASEINÄ YHDISTAMISPALKIT BJÄLKAR FÖR SIDOVÄGG SAMMANSLAGNING 	2	45x70	1976
F1	FLOORBOARD - LATTIALAUTA - GOLVBRÄDE  88mm or -tai- eller 114mm	34+1 43+1	18x114 18x88	1900
F2	FLOORBOARD - LATTIALAUTA - GOLVBRÄDE  88mm or -tai- eller 114mm	34 43	18x114 18x88	600
R1	ROOFBOARD - KATTOLAUTA - TAKBRÄDE  88mm or -tai- eller 114mm	34+1 45+1	18x114 18x88	2330 2330
R2	ROOFBOARD - KATTOLAUTA - TAKBRÄDE  88mm or -tai- eller 114mm	17+1 23+1	18x114 18x88	1950 1950
R3	ROOFBOARD - KATTOLAUTA - TAKBRÄDE  88mm or -tai- eller 114mm	34 45	18x114 18x88	1355 1355
FF	FLOOR FILLET - LATTIALISTA - GOLVLIST 	8	18x35	1900
GB1	GABLE BOARD - KAAPELILAUTA - GAVELBRÄDA 	6	18x90	1792
GB2		4	18x90	890
GS	GABLE SLAT - KAAPELILISTA - VINDLIST 	4	30x40	1792
GCB	GABLE BOARD CONNECTING BOARD - KAAPELILAUTA YHDISTAMISLAUTA - BRÄDE FÖR FIXERA VINDBRÄDE 	12	18x70	130
RFF1	ROOF FELT FILLET - KATON PÄÄTYLAUTA - BRÄDE OVANPÅ GAVELBRÄDE 	4	18x70	1790
RFF2		2	18x70	2280
EB1	EAVE BOARD - RÄYSTÄSLAUTA - TAKFOTSBRÄDE 	2	18x90	2350
EB2	EAVE BOARD - RÄYSTÄSLAUTA - TAKFOTSBRÄDE 	10	18x90	1980
EB3	EAVE BOARD - RÄYSTÄSLAUTA - TAKFOTSBRÄDE 	5	18x90	1950
EB4	EAVE BOARD - RÄYSTÄSLAUTA - TAKFOTSBRÄDE 	8	18x90	1000
EB5	EAVE BOARD - RÄYSTÄSLAUTA - TAKFOTSBRÄDE 	2	18x120	2350
EB6	EAVE BOARD - RÄYSTÄSLAUTA - TAKFOTSBRÄDE 	2	18x90	1375
CB1	CORNER BOARD - KULMANLAUTA - HÖRNBRÄDE 	2	18x90	2090
CB2		6	18x90	2040
CB3	CORNER BOARD - KULMANLAUTA - HÖRNBRÄDE 	2	18x90	569
CB4	CORNER BOARD - KULMANLAUTA - HÖRNBRÄDE 	2	18x90	569
FIL1	FILLING BOARD- TÄYTTÖLAUTA- FYLLNADSBRÄDE 	2	16x80	2060
FIL2	FILLING BOARD- TÄYTTÖLAUTA- FYLLNADSBRÄDE 	2	16x70	2060













Kood EL Julian

Materjal

File EL Julian.dwg

Leht 15

2 PAKKI L<2.35m

Pos	EL Julian	Nr. Pcs.	Profile (mm)	L (mm)
	DOOR HANDLE - OVEN KAHVA - DÖRR HANDTAG 	1		
	DOOR LOCK+KEYS - OVENLUKKO+AVAIN - DÖRRLAS+NYCKLAR 	1		
	STEEL CORNER - KULMARAUTA - VINKELJÄRN 	10	90x90	65
	STEEL PLATE - METALLILEVY - METALLPLATTA 	4	2,5x60	160
	NAILS - NAULAT - SPIKAR  FERMS - KATTOPARRU - TAKLÄGGNING	108	5,0	120
	NAILS - NAULAT - SPIKAR  FLOORBOARD - LATTIALAUTA - GOLVBRÄDE NAILS - NAULAT - SPIKAR  ROOFBOARD - KATTOLAUTAT - TAKBRÄDE SKIRTING SLAT - LATTIALISTA - GOLVLIST	700 32	2,5 2,0	60 40
	SCREW - RUUVIT - SKRUVAR  ELEMENT - ELEMENT - ELEMENTTI EL-9 & EL-10 EL-11 & EL-12	18	5,0	120
	SCREW - RUUVIT - SKRUVAR  FLOORBEAMS - LATTIAPALKIT - GOLVBJÄLKAR SCREW - RUUVIT - SKRUVAR  ELEMENT CONNECTING - ELEMENTTI YHDISTAMIS - ELEMENT SAMMANSLAGNING STEEL PLATE - METALLILEVY - METALLPLATTA	225 40	4,5 5,0	70 40
	SCREW - RUUVIT - SKRUVAR  STEEL CORNER - KULMARAUTA - VINKELJÄRN EAVE BOARD - RÄYSTÄSLAUTA - TAKFOTSBRÄDE CORNER BOARD - KULMANLAUTA - HÖRNBRÄDE GABLE BOARD - KAAPELILAUTA - GAVELBRÄDA GABLE SLAT - KAAPELIJUSTA - VINDLIST ROOF FELT FILLET - KATON PÄÄTYLAUTA - BRÄDE OVANPÅ GAVELBRÄDE	370	4,5	45

WS-1

WATER SILL

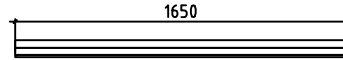
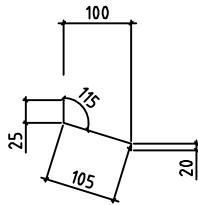

1



Polhus

Kood EL Julian

Materjal

File EL Julian.dwg

Leht 16

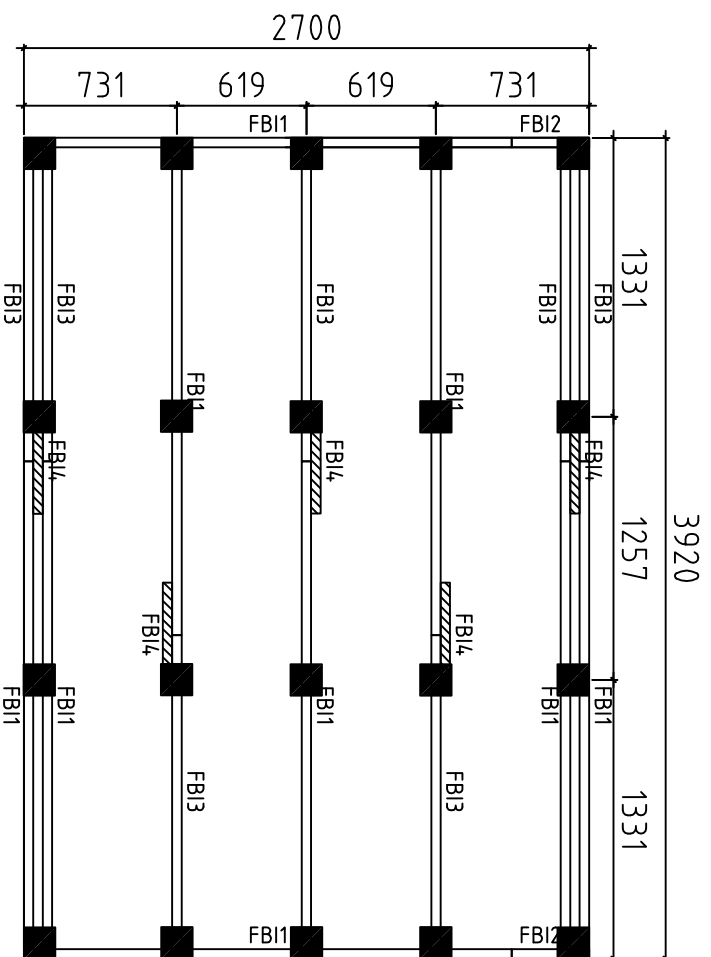

Detta är ett förslag för hur man kan placera plintarna (100-200 mm i diamaten) för golvväggsklaget. Golvväggsklaget är med i byggsatsen, men inte plintarna. Använder man exempelvis 500-600mm långa murblock så kan man halvera antalet punkter. Lägg fuktskyddande papp mellan betong och trä

Tämä on ehdotus siitä, miten (100-200 mm läpimittaiset) jalat voidaan sijoittaa alapohjan varten. Lattiapakit ovat rakennussarjassa, mutta jalat ei ole. Kun käytetään esimerkiksi 500-600 mm pitkiä harkkoja, voidaan pisteiden määrä puolittaa. Aseta betonin ja puun välillä kosteudelta suojaava pähvi

A proposal for placing plinths (100-200 mm in diameter) for floor beams. Floor beams are provided in the kit but plinths are not included. For example, by using 500-600 mm long masonry units, one can reduce the number of points 50%. Place cardboard between the concrete and wood to protect from moisture

Date rev. Description

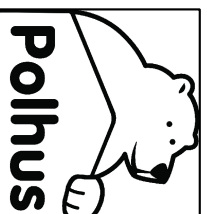

House	EL Julian	Sheet	17
Drawing	Plan	Scale	1:35
Material		Date	25.03.2021
Drawer	K.K.	File	EL Julian.dwg