

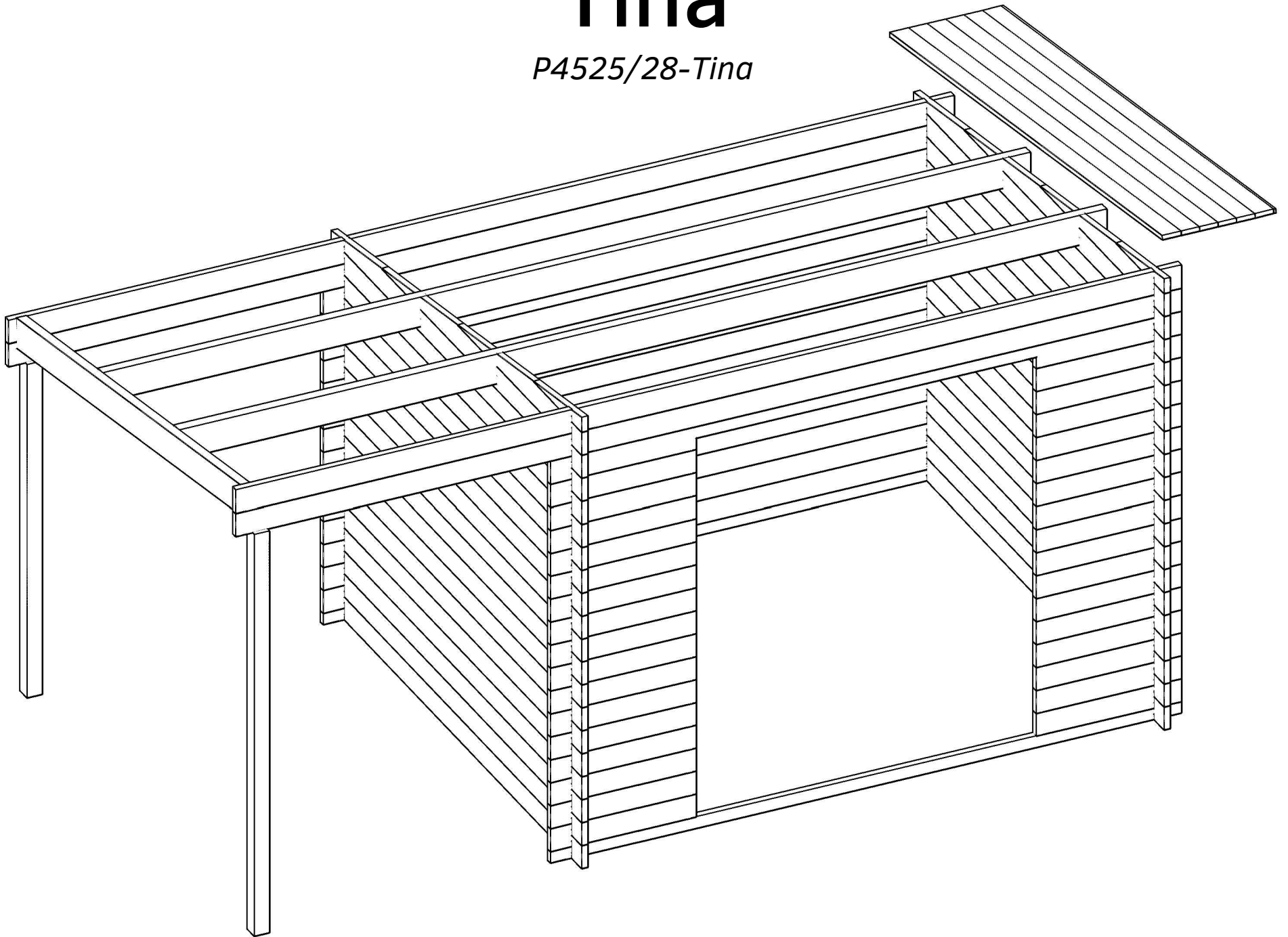

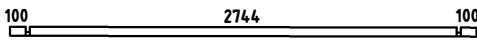

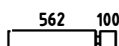

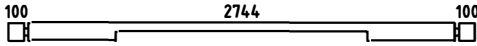

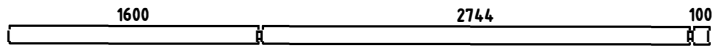
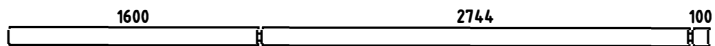
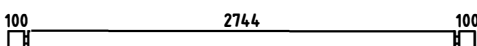
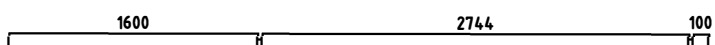
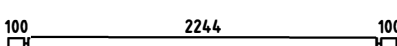
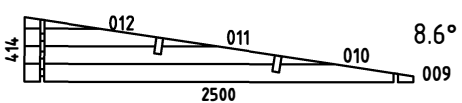
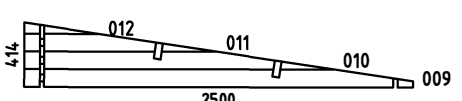

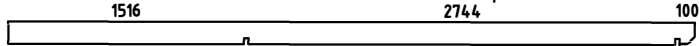
# Tina

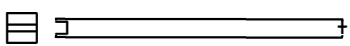
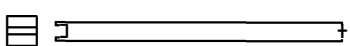
*P4525/28-Tina*

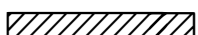

Pos	Specification-Spezifikation-Specificatie	St.	Profile (mm)	Length (mm)
001		2	28x57	3000
002		32	28x114	690
003		1	28x114	3000
004		2	28x114	4500
005		1	28x114	4500
006		14	28x114	3000
007		1	28x114	4500
008		32	28x114	2500
WB-1		1		
WC-1		1		
SR1	RAFTER-DACHSPARREN-DAKSPAR 	1	44x144	2291
PR1	Purlin-Dakbalk-Dachpfette 1516 2744 100 	2	44x144	4416
DP-1	Roof board-Dachbrett-Dakplank 	52	88x18	2750
	-POST 85x85 	1		1700
	-POST 85x85 	1		2040
L-1	Eave Board-Traufenblende-Afdeklank 	2	18x120	2790
L-2	Facia Board-Giebelblende-Gevelplank 	2	18x120	4536
	Storm Brace-Sturmleiste 	2	18x40	1820
	Storm Brace-Sturmleiste 	2	18x40	2000
	Adjustable foot-Stellfuß+Schrauben 5x40 4stück für Post 	2		
	Double Door Set-Doppeltür Satz-Dubbele Deur Set 	1		
	Nail-Nagel-Spijker 	230	1.8x40	
	Nail-Nagel-Spijker 1.6x30 	15	1.6x30	

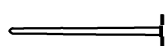
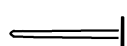



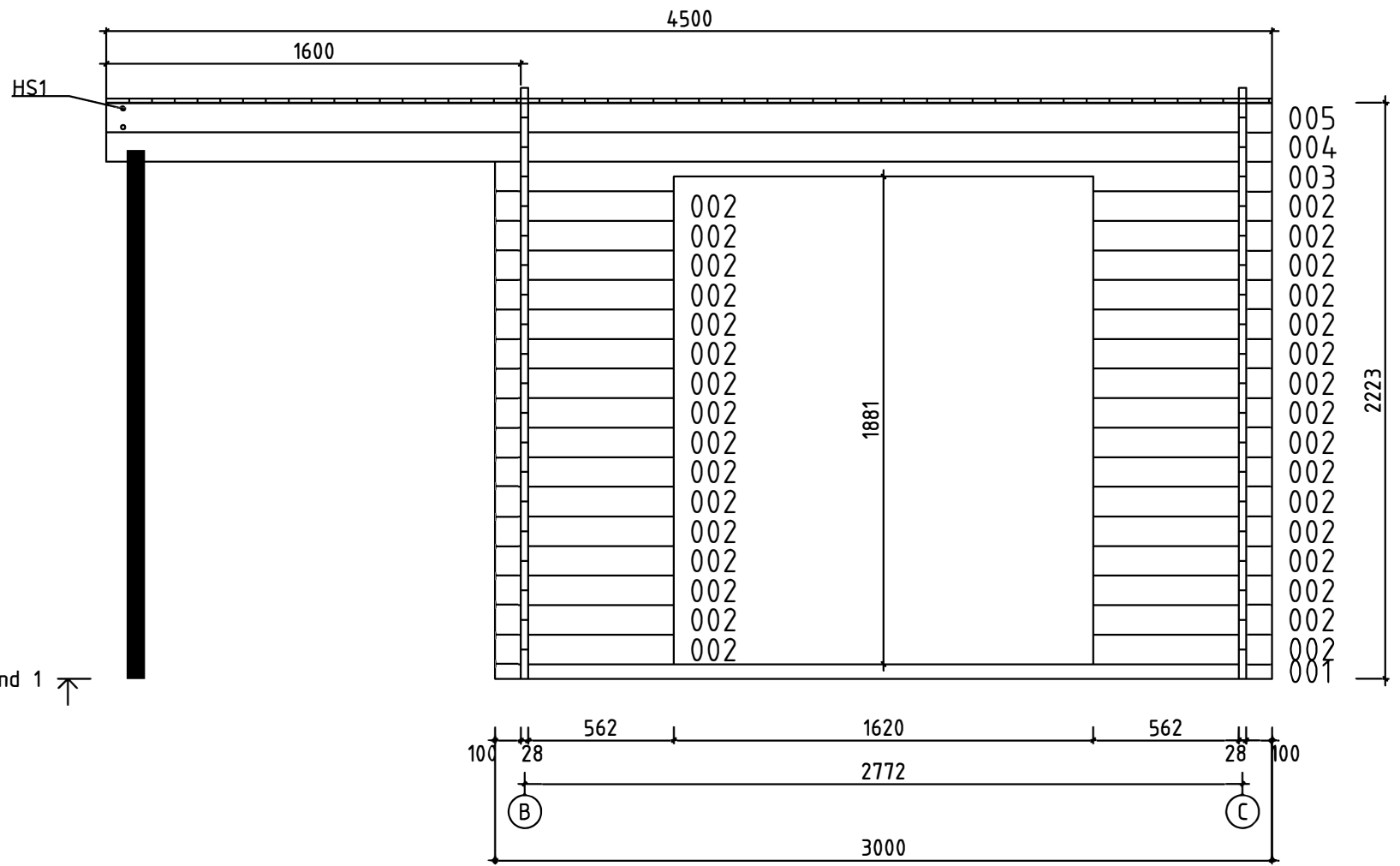

Model	Tina, 28 mm	Page	5
Drawn by	R.Tamm	Material	2.8x11.4
Date	15.01.2020	File	Tina_28.dwg
		Scale	1:25



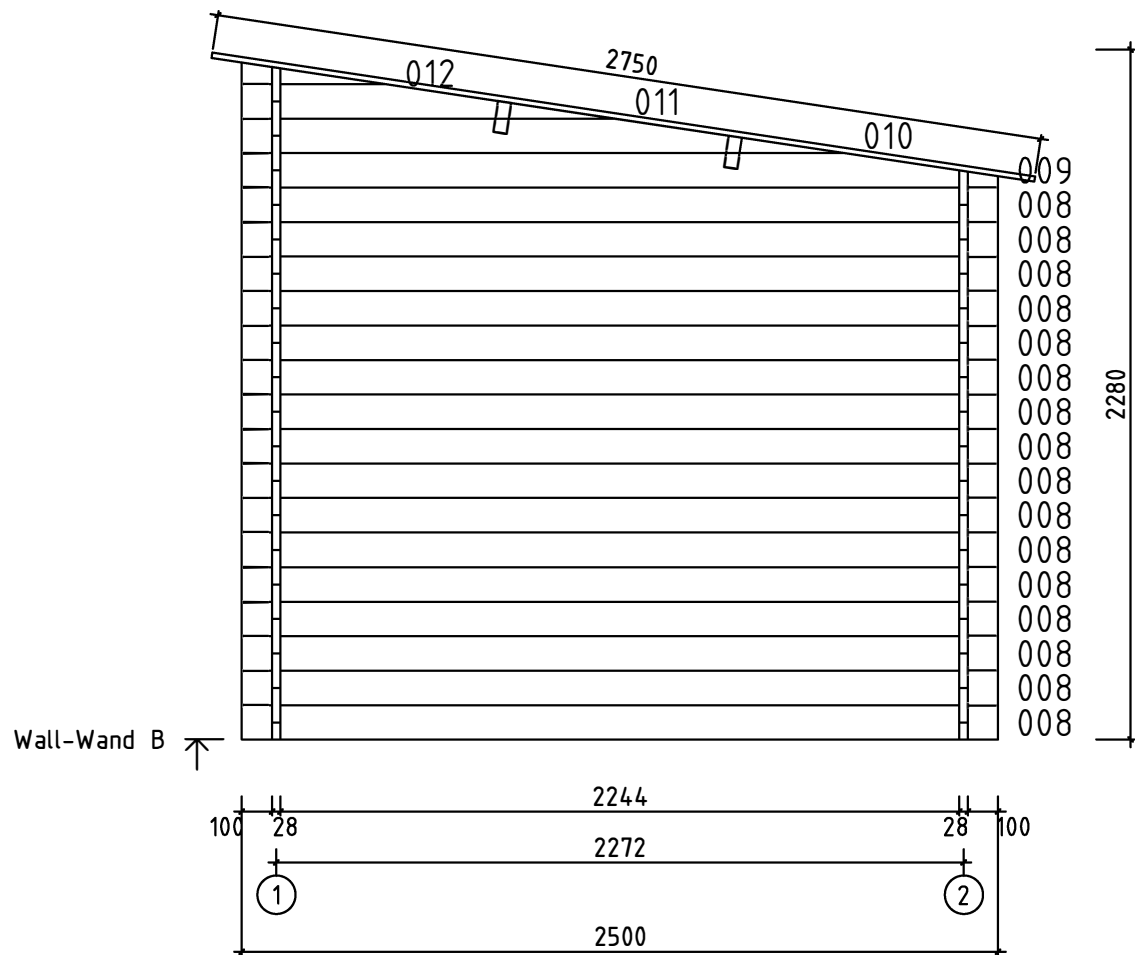

Model	Tina, 28 mm_	Page	3
Drawn by	R.Tamm	Material	2.8x11.4
Date	15.01.2020	File	Tina_28.dwg

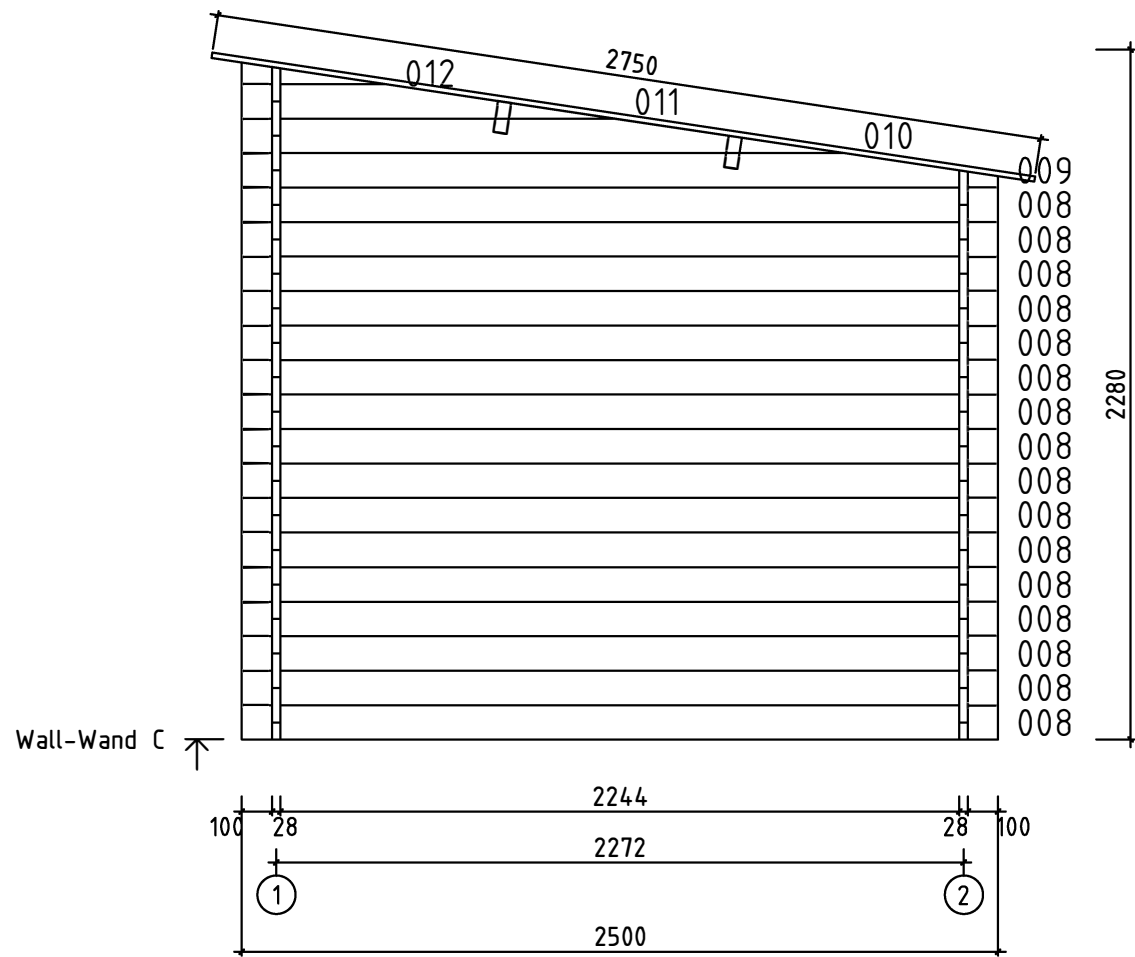

Model	Tina, 28 mm_	Page	4
Drawn by	R.Tamm	Material	2.8x11.4
Date	15.01.2020	File	Tina_28.dwg
		Scale	1:25



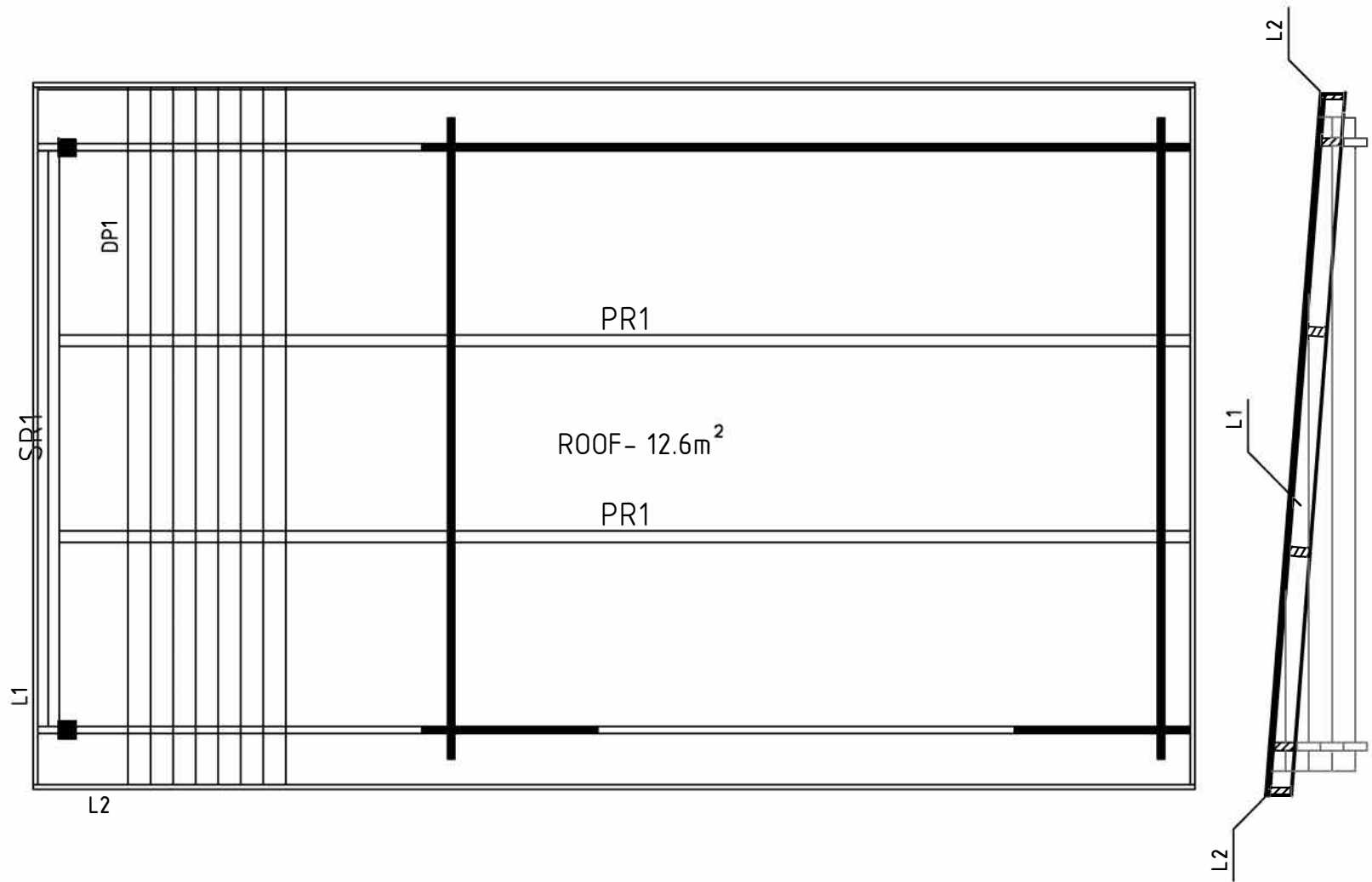

Model	Tina, 28 mm_	Page	ROOF
Drawn by	R.Tamm	Material	2.8x11.4
Date	15.01.2020	File	Tina_28.dwg
		Scale	1:25

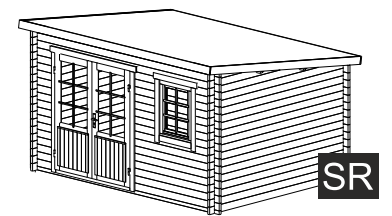
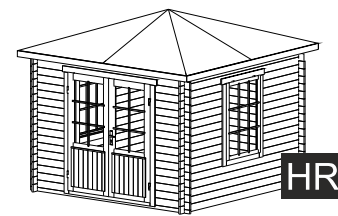
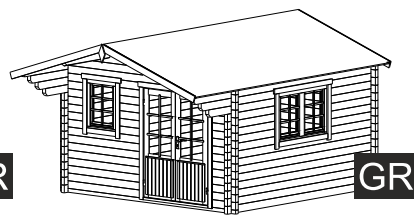
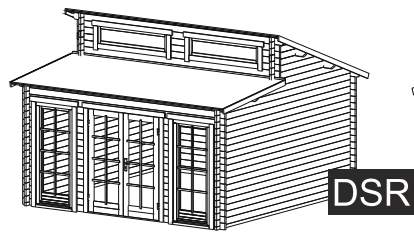
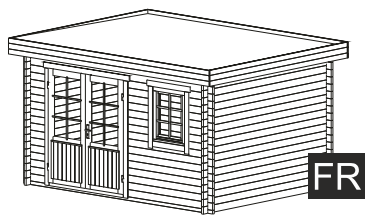

FR

DSR

GR

HR

SR

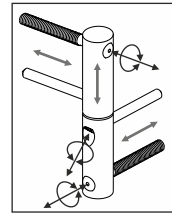
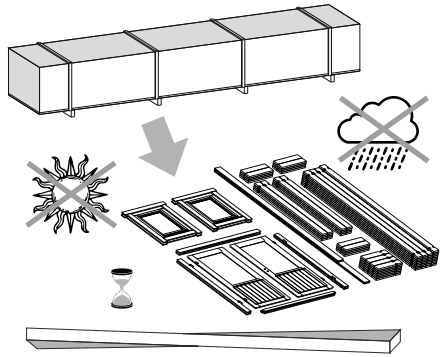

ADJUSTABLE HINGES

3.

TYPE- A  
5x90

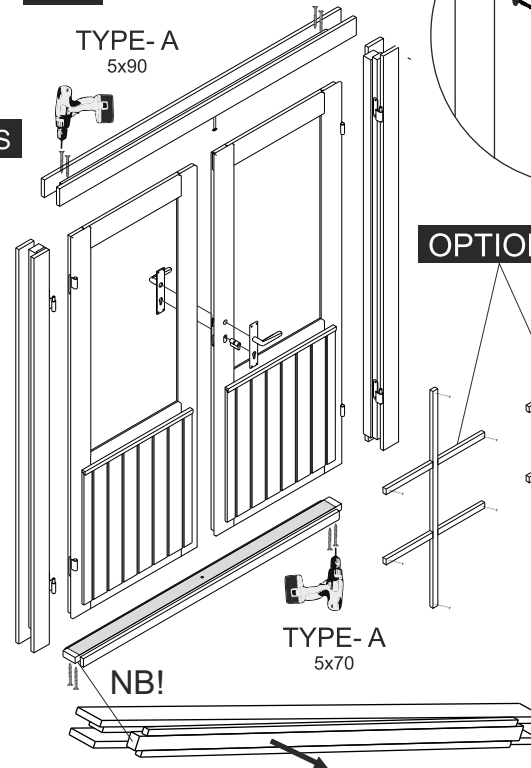

OPTIONS

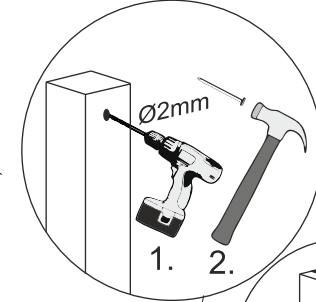

1. 2.

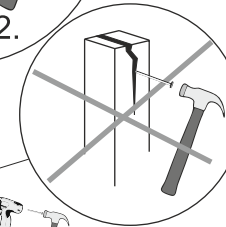

4.

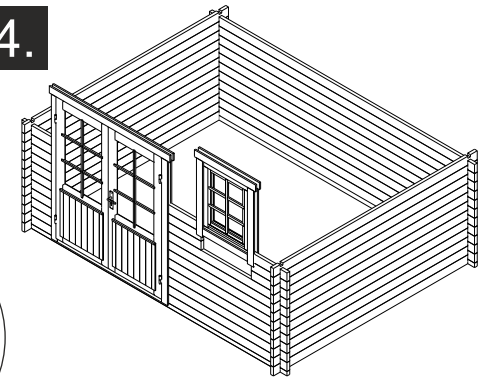

1.

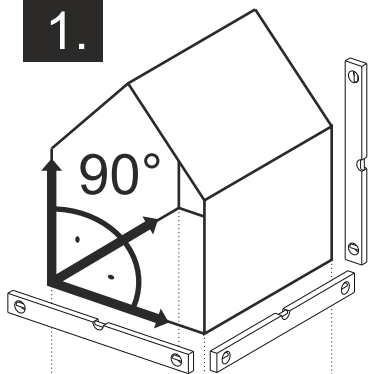

90°

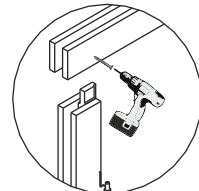

TYPE- B  
4x60

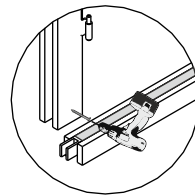

5.

OPTIONS

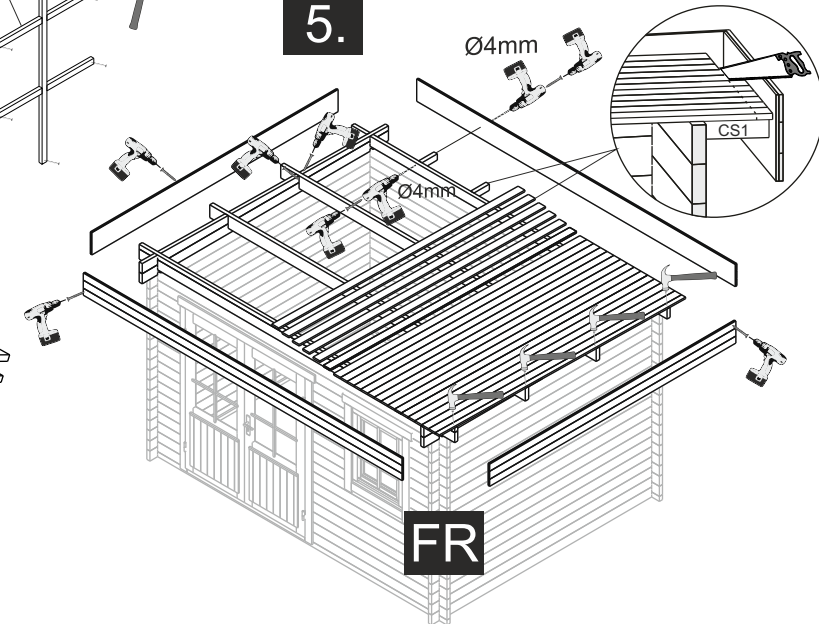

Ø4mm

Ø4mm

CS1

NB!

TYPE- A  
5x70

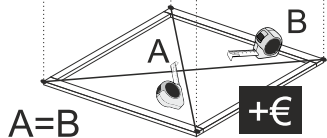

A=B

+€

2.

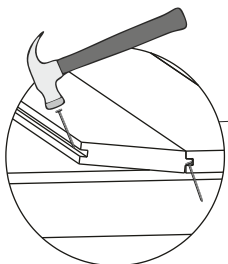

OPTIONS

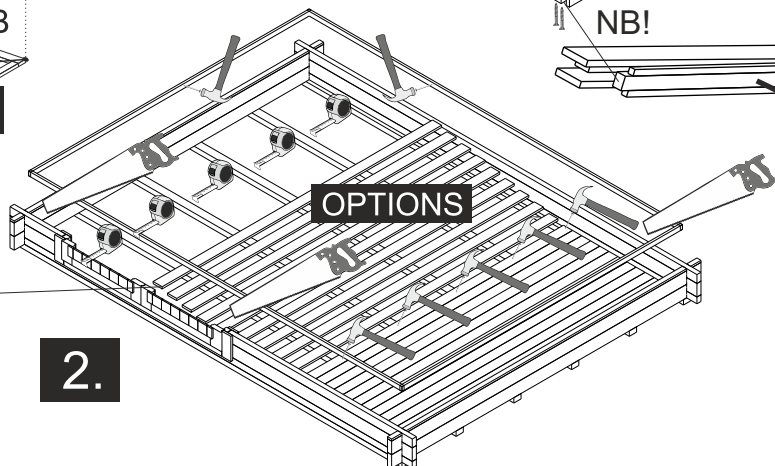

The guide is illustrative. This guide is not project specification.  
Der Leitfaden ist illustrativ. Dieser Leitfaden ist keine Projektspezifikation.  
De gids is illustratief. Deze gids is geen projectspecificatie.

5.

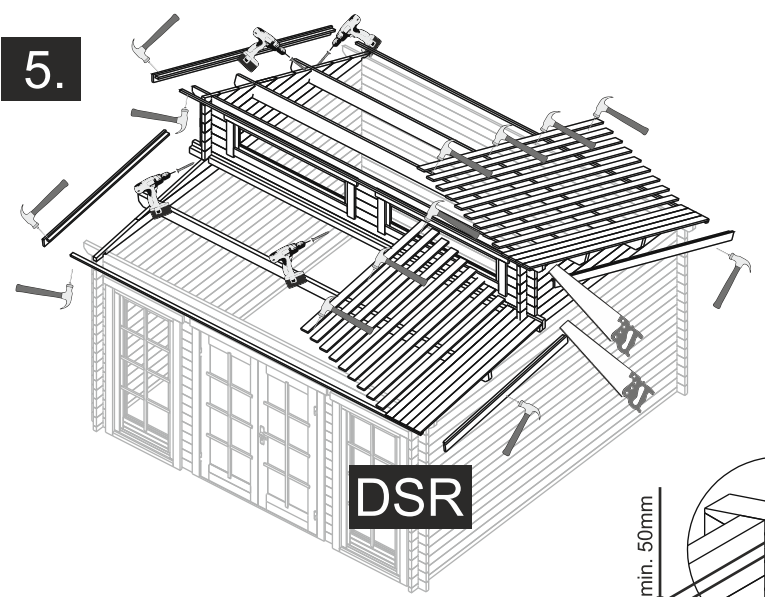

5.

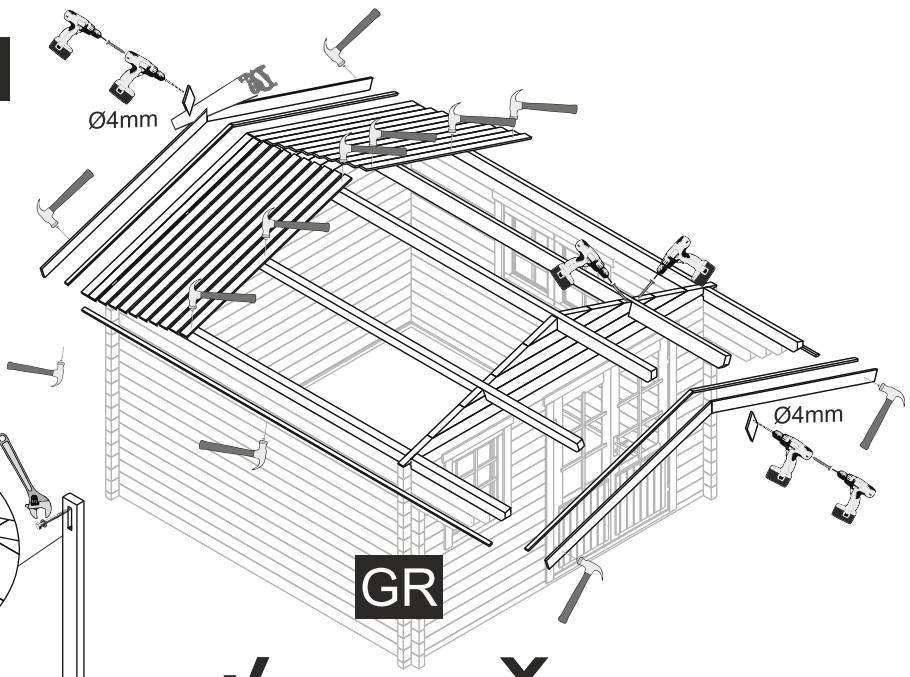

OPTIONS

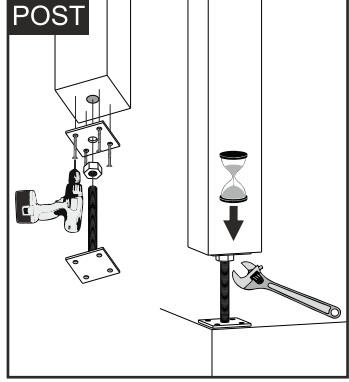
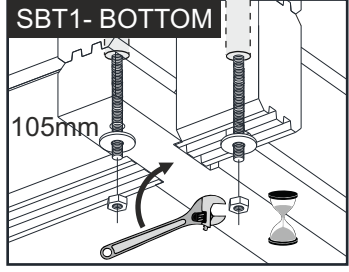
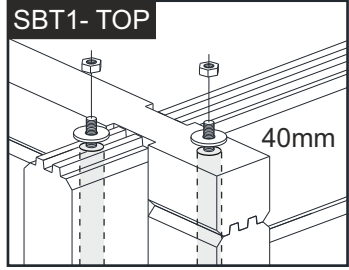
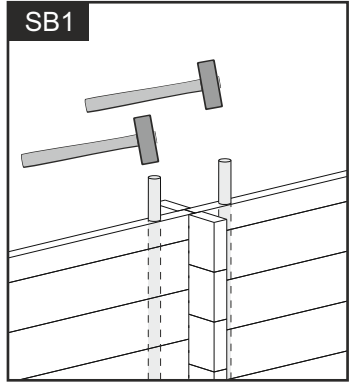

NB!

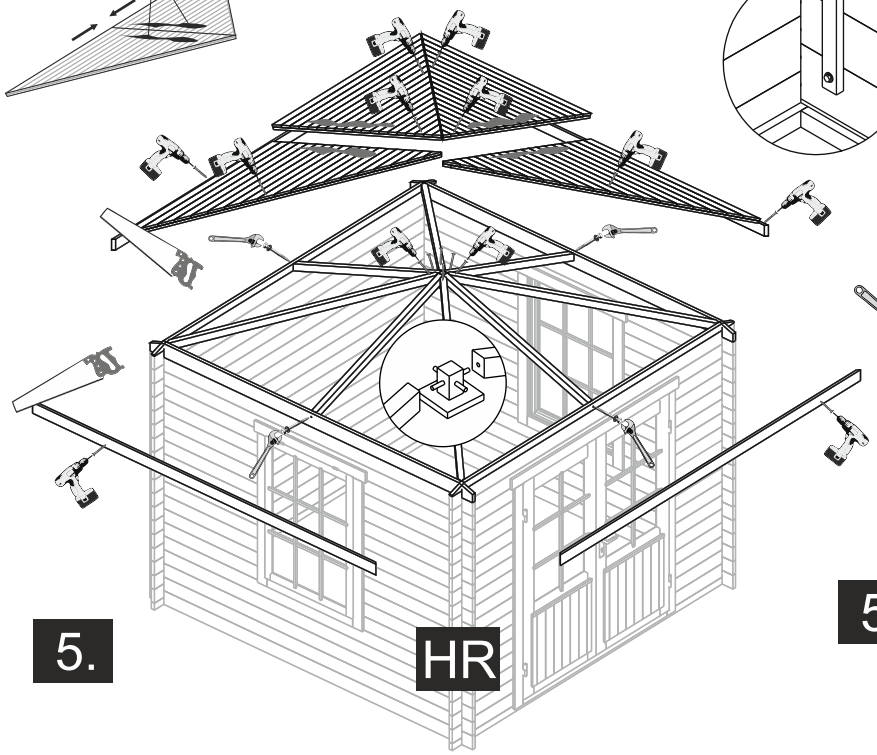

5.

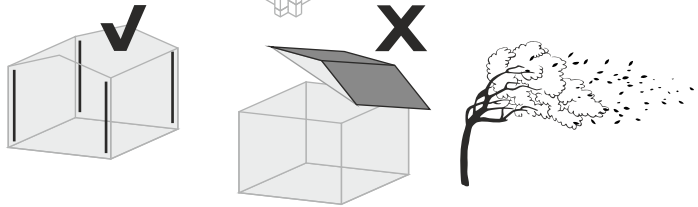
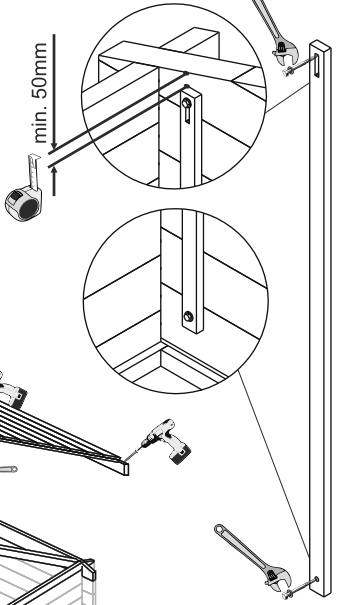

OPTIONS-STORM BRACES

5.

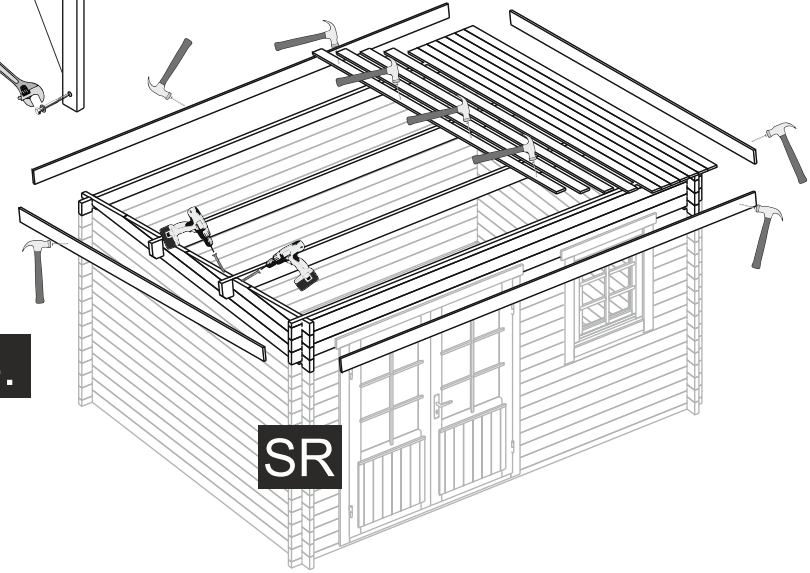

SR