

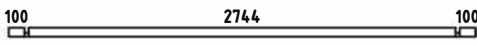









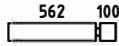

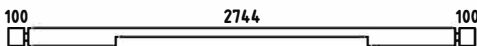

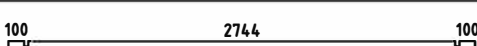
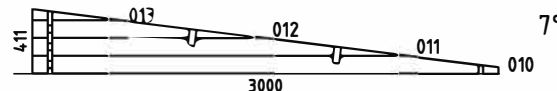
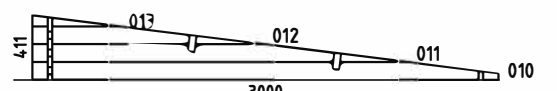
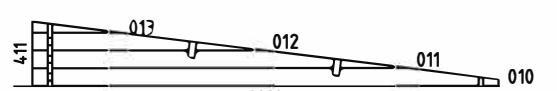
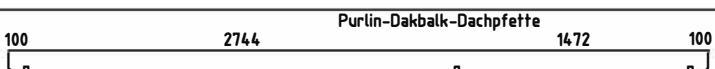

**Karin**

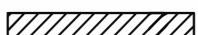
*P4328/28-Karin*

Pos	Specification-Spezifikation-Specificatie	St.	Profile (mm)	Length (mm)
001		1	28x57	3000
002		1	28x57	228
003		32	28x114	690
004		31	28x114	228
005		1	28x114	3000
006		16	28x114	4500
007		2	28x114	4500
008		1	28x57	4500
009		41	28x114	3000
WA-1		1		
WB-1		1		
WC-1		1		
PR1		2	44x14.4	4500
DP-1	Roof board-Dachbrett-Dakplank 	52	88x18	3250
L-1	Eave Board-Traufenblende-Afdeklank 	2	18x120	3290
L-2	Facia Board-Giebelblende-Gevelplank 	2	18x120	4536
	Storm Brace-Sturmleiste 	2	18x40	1820
	Storm Brace-Sturmleiste 	2	18x40	2000
	Double Door Set-Doppeltür Satz-Dubbele Deur Set  3x25 x2 4x60 x4	1		
	Nail-Nagel-Spijker 	230	1.8x40	
	Nail-Nagel-Spijker 1.3x60 	15	1.3x60	
	Ventilation Panel-Lüftungsgitter Set 	1		



H = 1.600 m  
 TOTAL: 11.57 m<sup>2</sup>

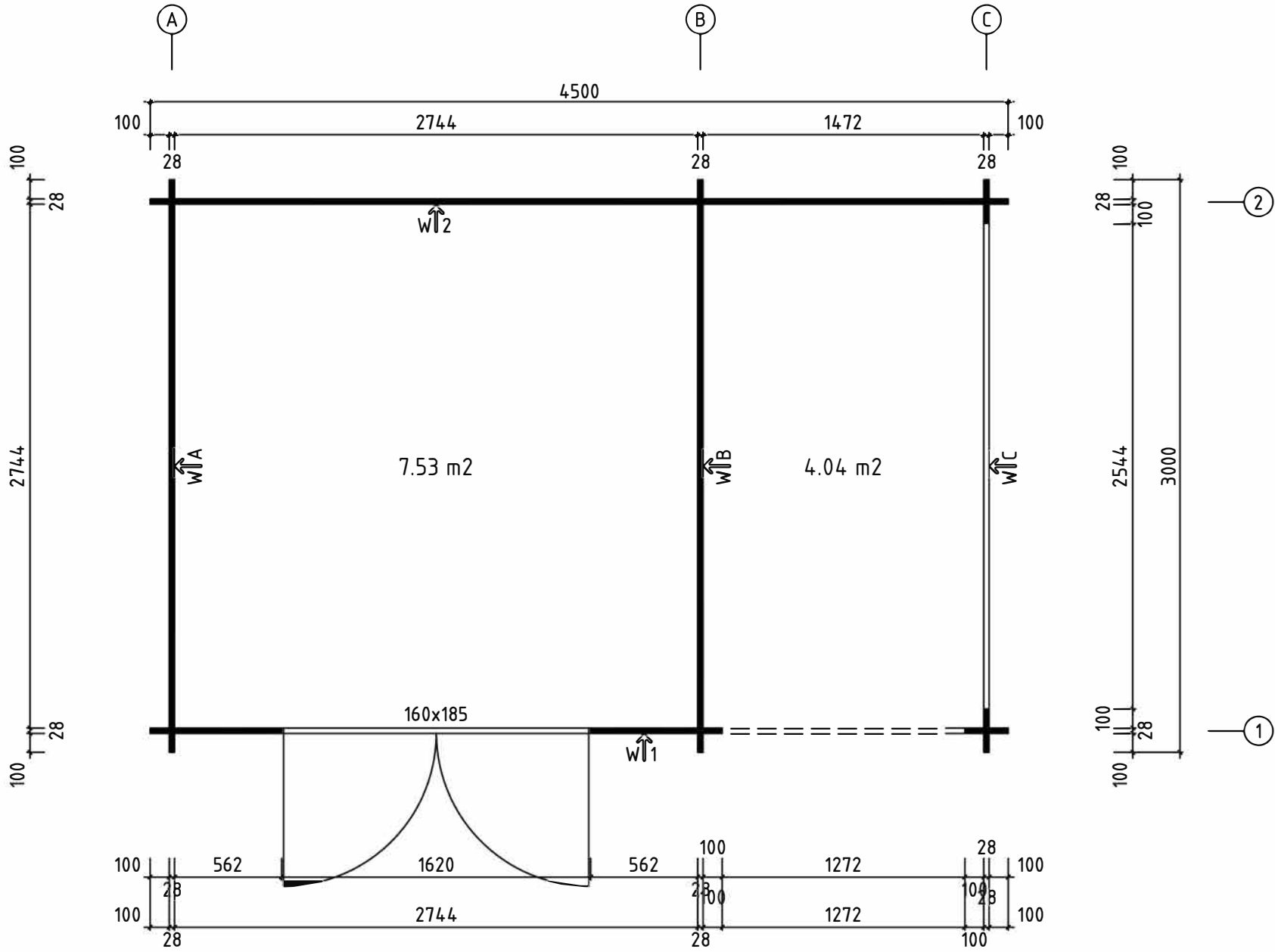

Model	Karin, 28 mm	Page	PLAN
Drawn by	J.Soo	Material	28x114
Date	08.04.2020	File	Karin_28.dwg
		Scale	1:30



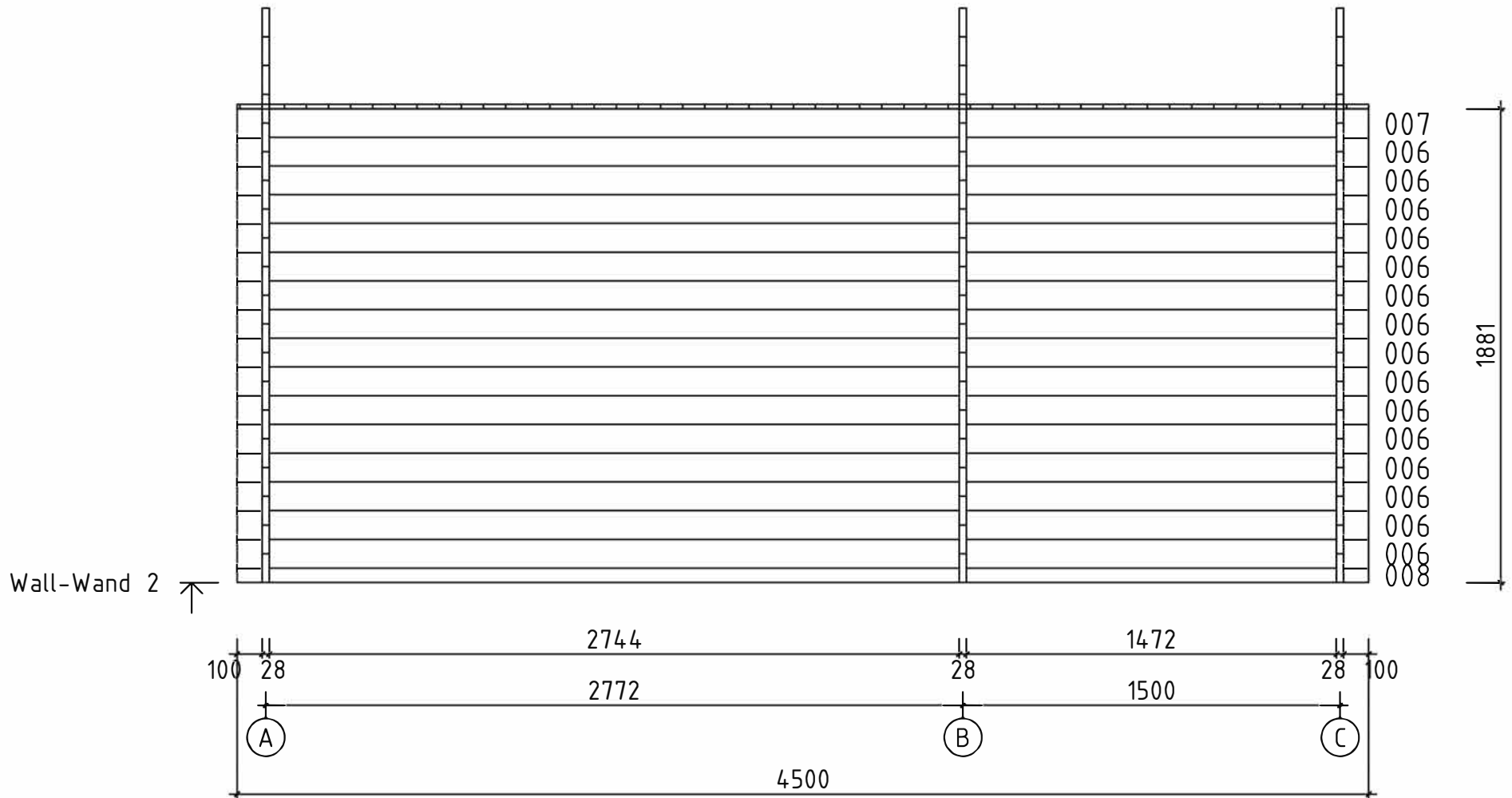

Model	Karin, 28 mm		Page	7	
Drawn by	J.Soo	Material	28x114	Scale	1:30
Date	08.04.2020				

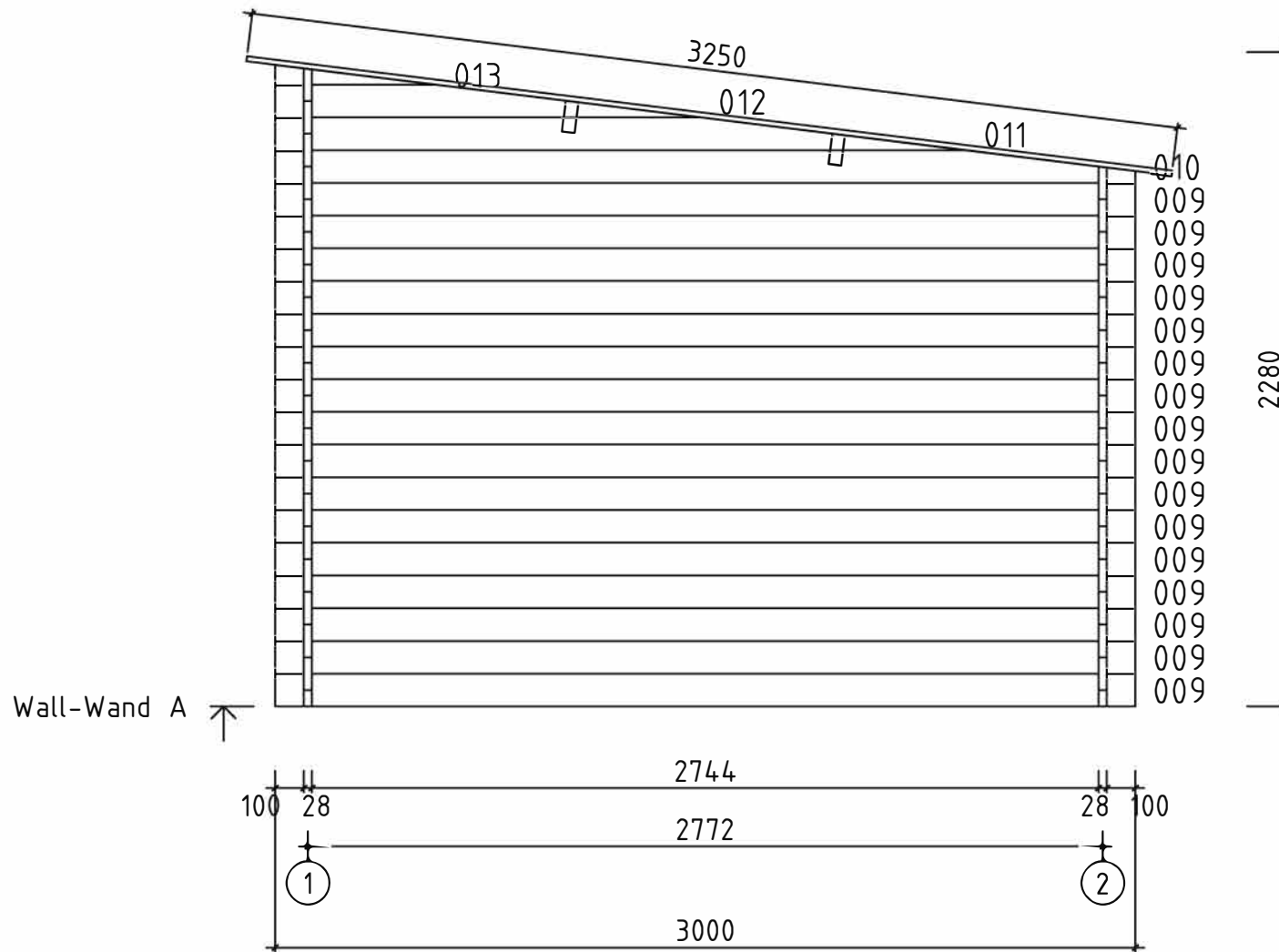

Model	Karin, 28 mm	Page	3
Drawn by	J.Soo	Material	28x114
Date	08.04.2020	Scale	1:30

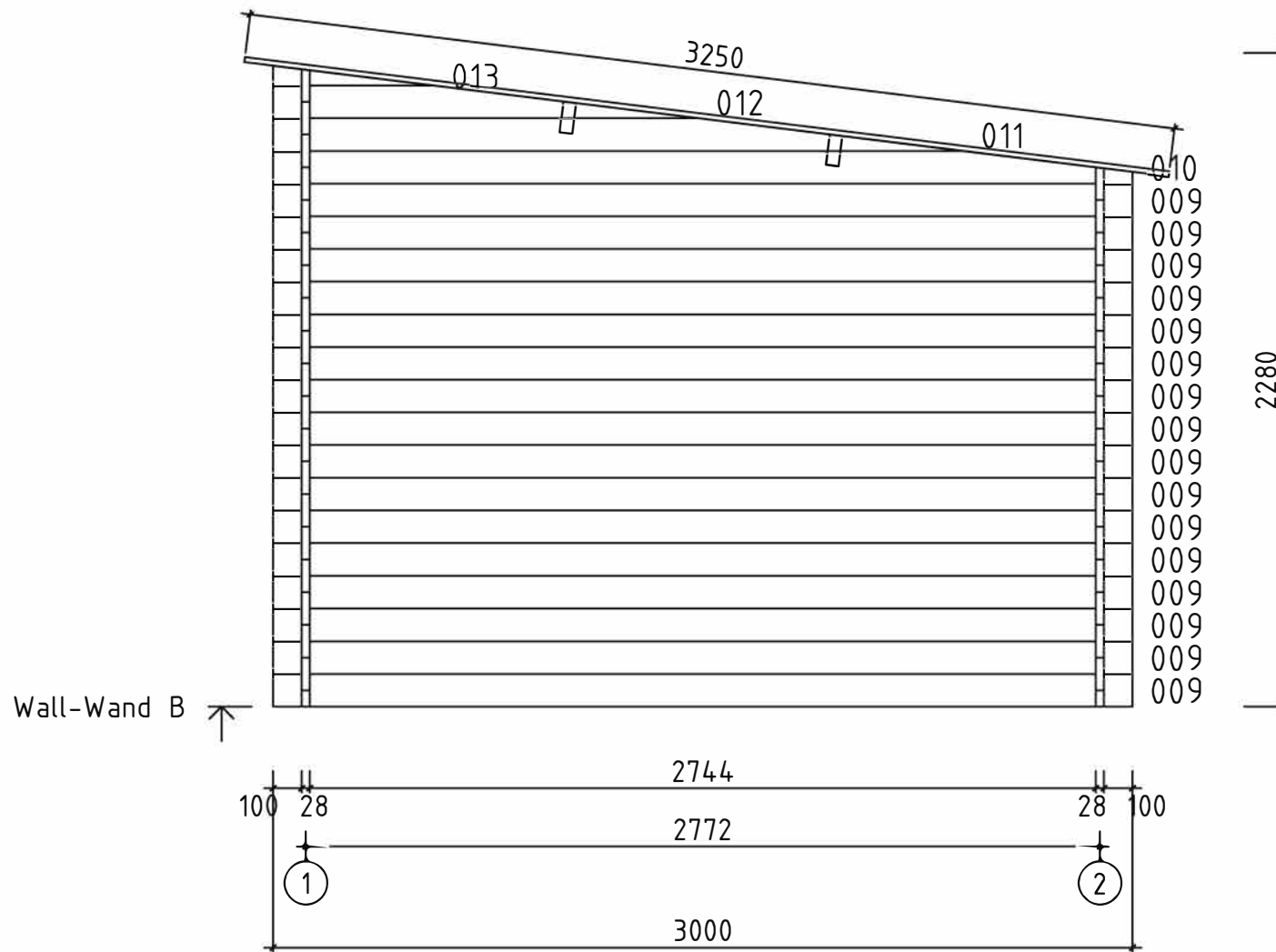

Model	Karin, 28 mm	Page	4
Drawn by	J.Soo	Material	28x114
Date	08.04.2020	Scale	1:30





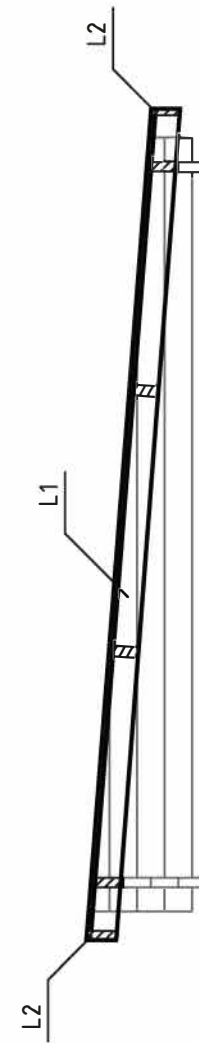
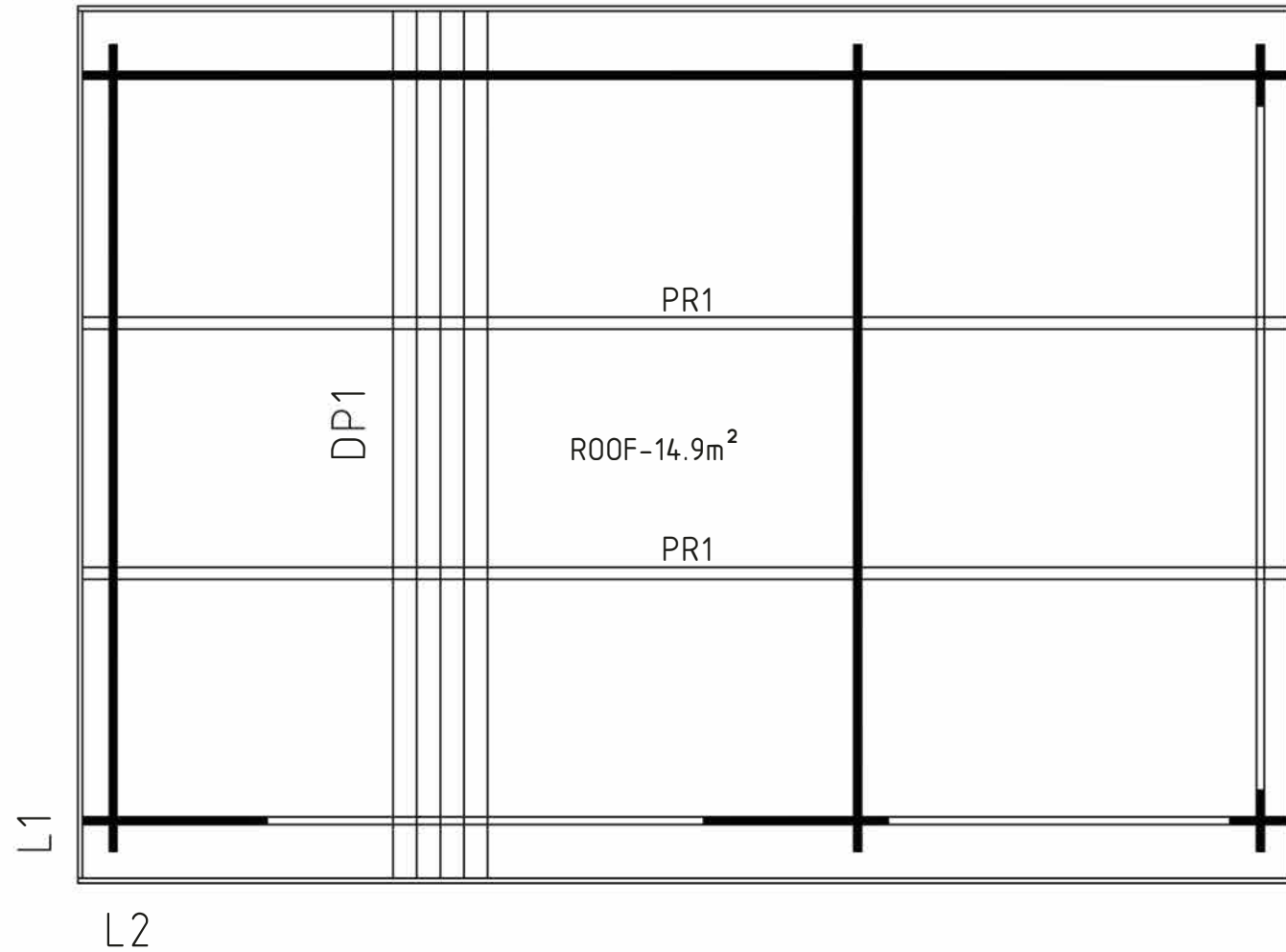

Model	Karin, 28 mm	Page	ROOF
Drawn by	J.Soo	Material	28x114
Date	08.04.2020	Scale	1:30