

Polhus

P5039/34-Tove
TOVE

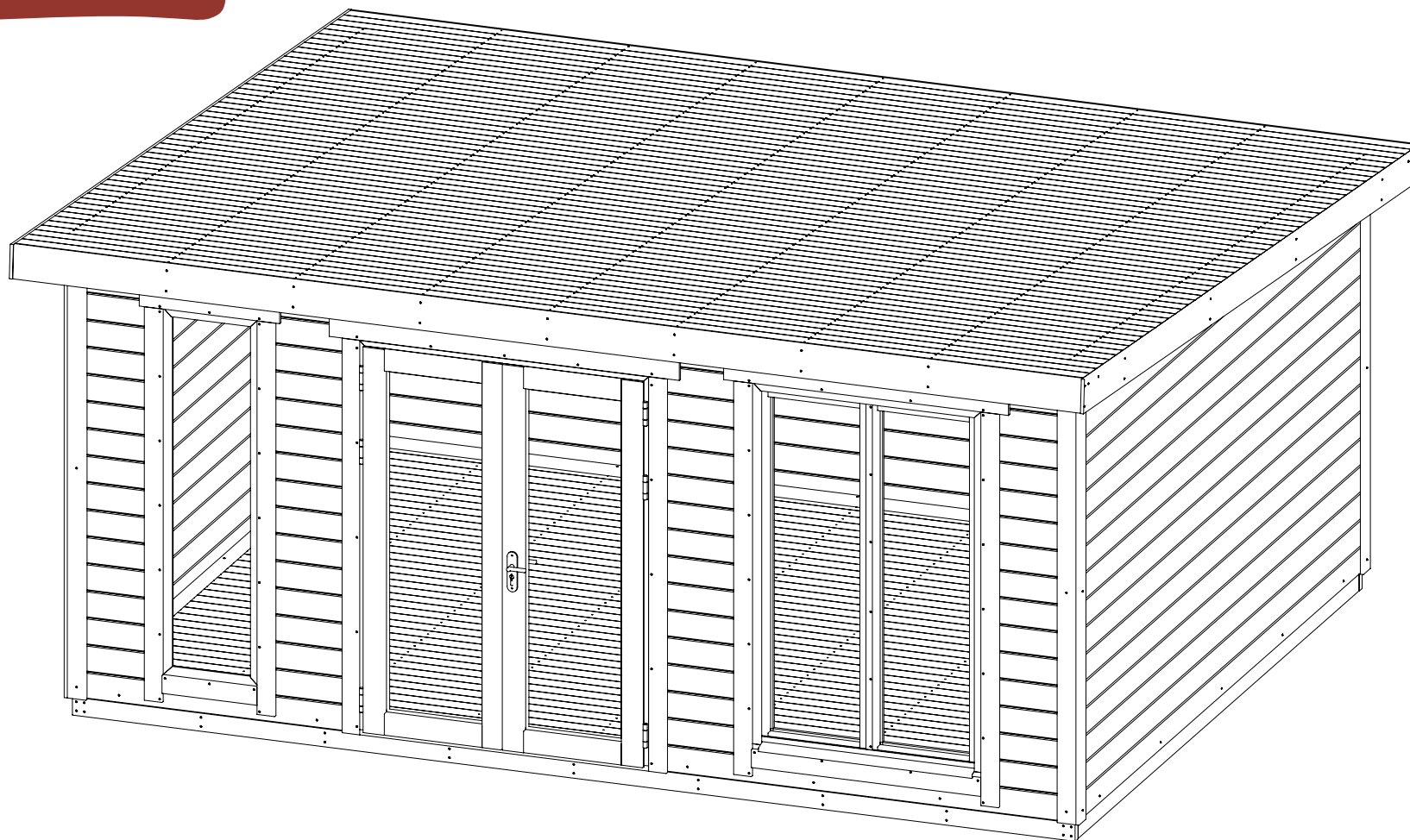





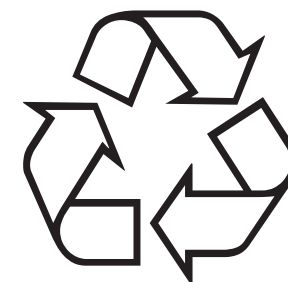





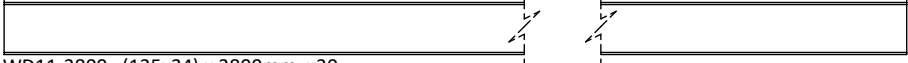
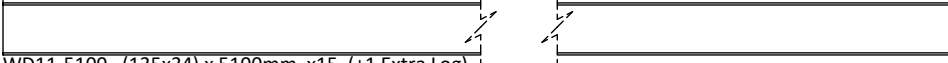
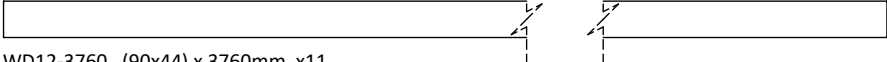
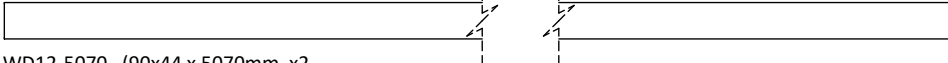

DE - Anweisungen für Montage, Wartung und sicheren Gebrauch.
EN - Instructions for assembly, maintenance and safe use.
FR - Instructions de montage, d'entretien et d'utilisation en toute sécurité.
NL - Instructies voor montage, onderhoud en veilig gebruik.
CZ - Pokyny pro montáž, údržbu a bezpečné použití.
SK - Návod na montáž, údržbu a bezpečné používanie.
SWE - Monteringsanvisning

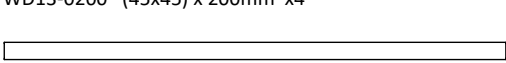
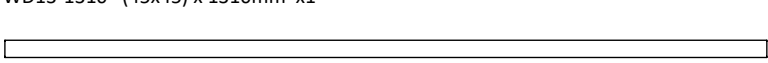
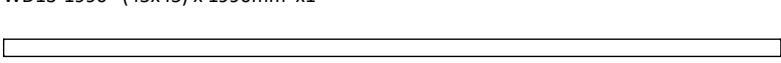
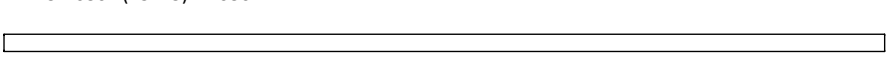
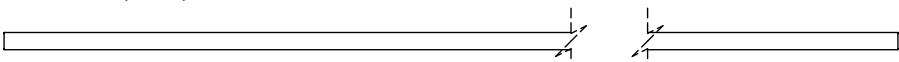
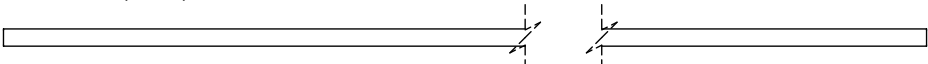
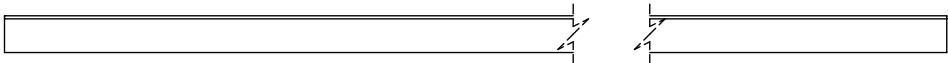
Polhus
Polhus Aktiebolag
Djäknegatan 31
211 35 Malmö
<https://www.polhus.com/>

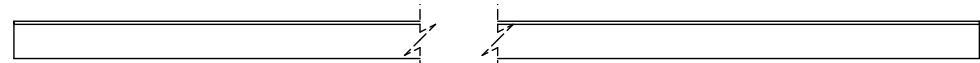

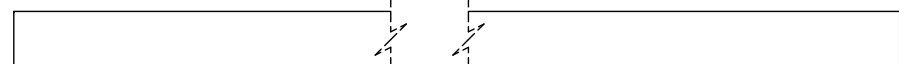
Issue - C 29/01/2024

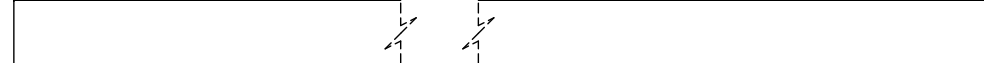
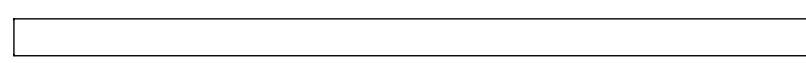
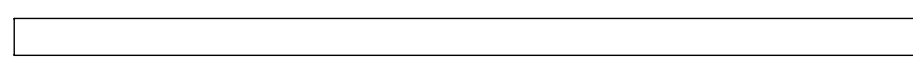
- W1  WD11-0430 (135x34) x 430mm x56
- W2  WD11-0602 (135x34) x 602mm x16
- W3  WD11-1420 (135x34) x 1420mm x1
- W4  WD11-2070 (135x34) x 2070mm x1
- W5  WD11-3800 (135x34) x 3800mm x30
- W6  WD11-5100 (135x34) x 5100mm x15 (+1 Extra Log)
- W7  WD12-3760 (90x44) x 3760mm x11
- W8  WD12-5070 (90x44 x 5070mm) x2
- W9  WD13-0200 (45x45) x 200mm x4
- W10  WD13-1310 (45x45) x 1310mm x1
- W11  WD13-1990 (45x45) x 1990mm x1
- W12  WD13-2030 (45x45) x 2030mm x2
- W13  WD13-2300 (45x45) x 2300mm x2
- W14  WD13-3710 (45x45) x 3710mm x2
- W15  WD13-4942 (45x45) x 4942mm x1
- W16  WD14-5030 (88x18) x 5030mm x44

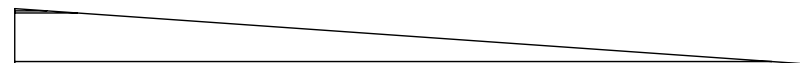
- W17  WD14-2700 (88x18) x 2700mm x103 (1 extra)
- W18  WD15-0150 (144x44) x 150mm x8
- W19  WD15-4500 (144x44) x 4500mm x7
- W20  WD32-4536 (170x18) x 4536mm x2
- W21  WD32-5400 (170x18) x 5400mm x2
- W22  WD34-2046 (95x18) x 2046mm x4
- W23  WD34-2318 (95x18) x 2318mm x4
- W24  WD1473 (135x34) x 3800mm x2
- W25  WD1474 (135x34) x 2027mm x2

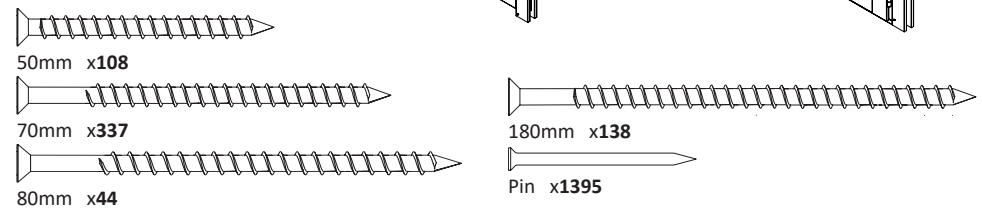
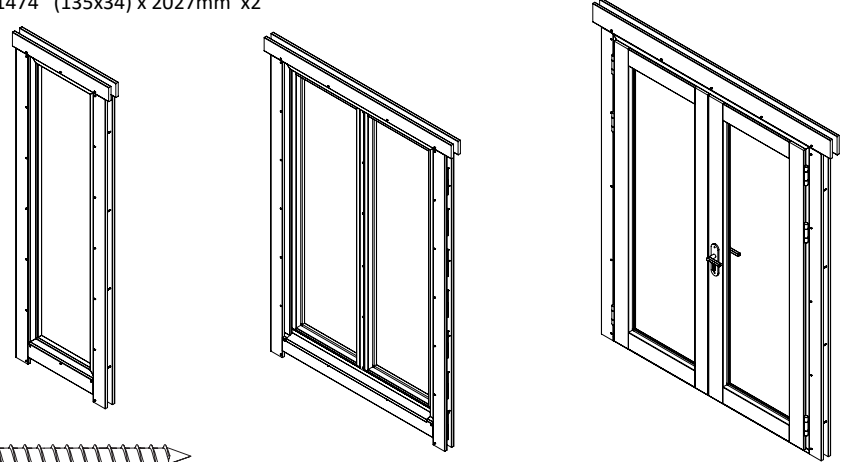

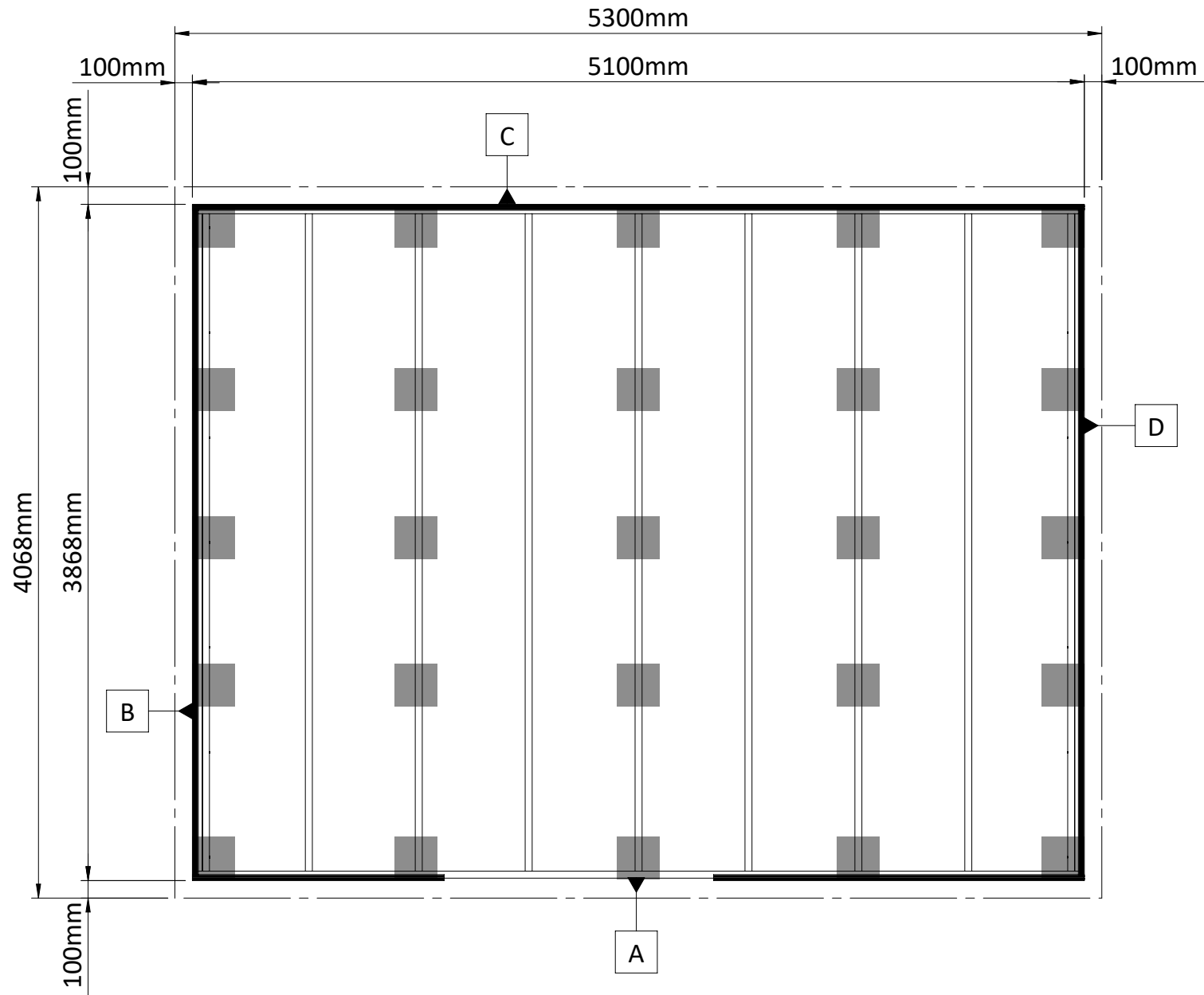

PLINTPLAN / FOUNDATION PLAN / BETONBLOCK / PLAN DE FONDATIONS

1A

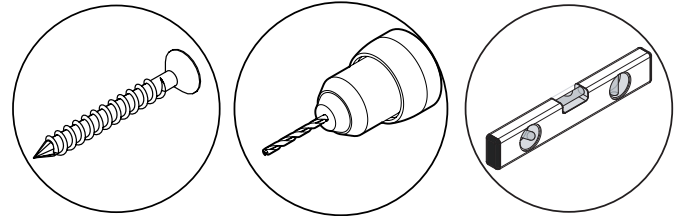
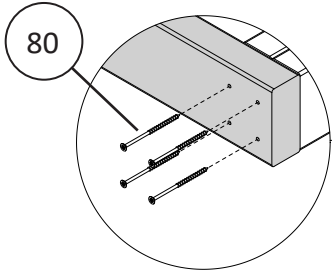
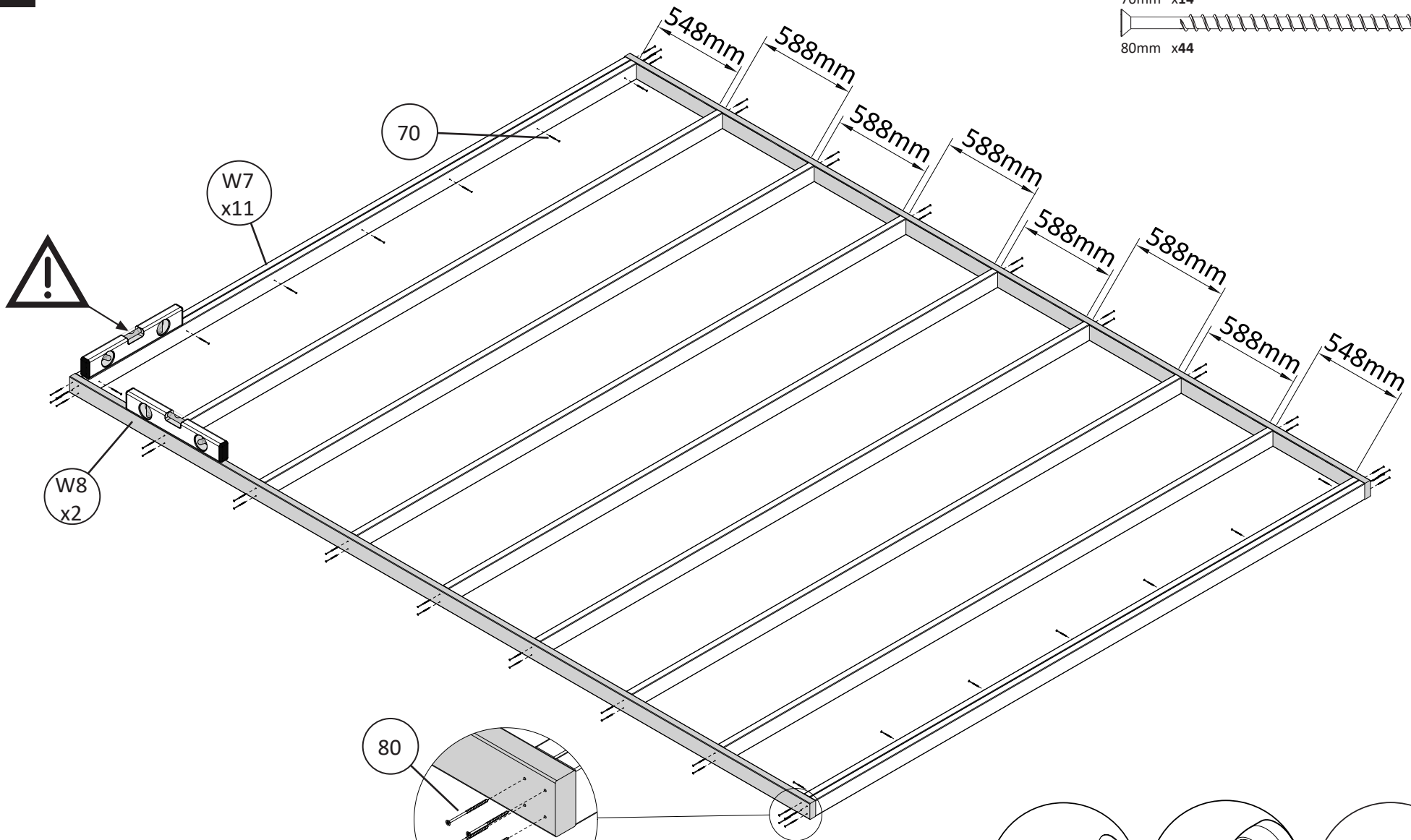
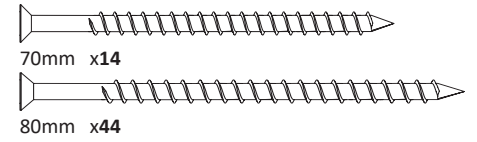

1B

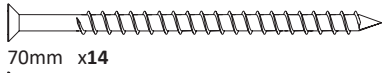

70mm x14



80mm x44

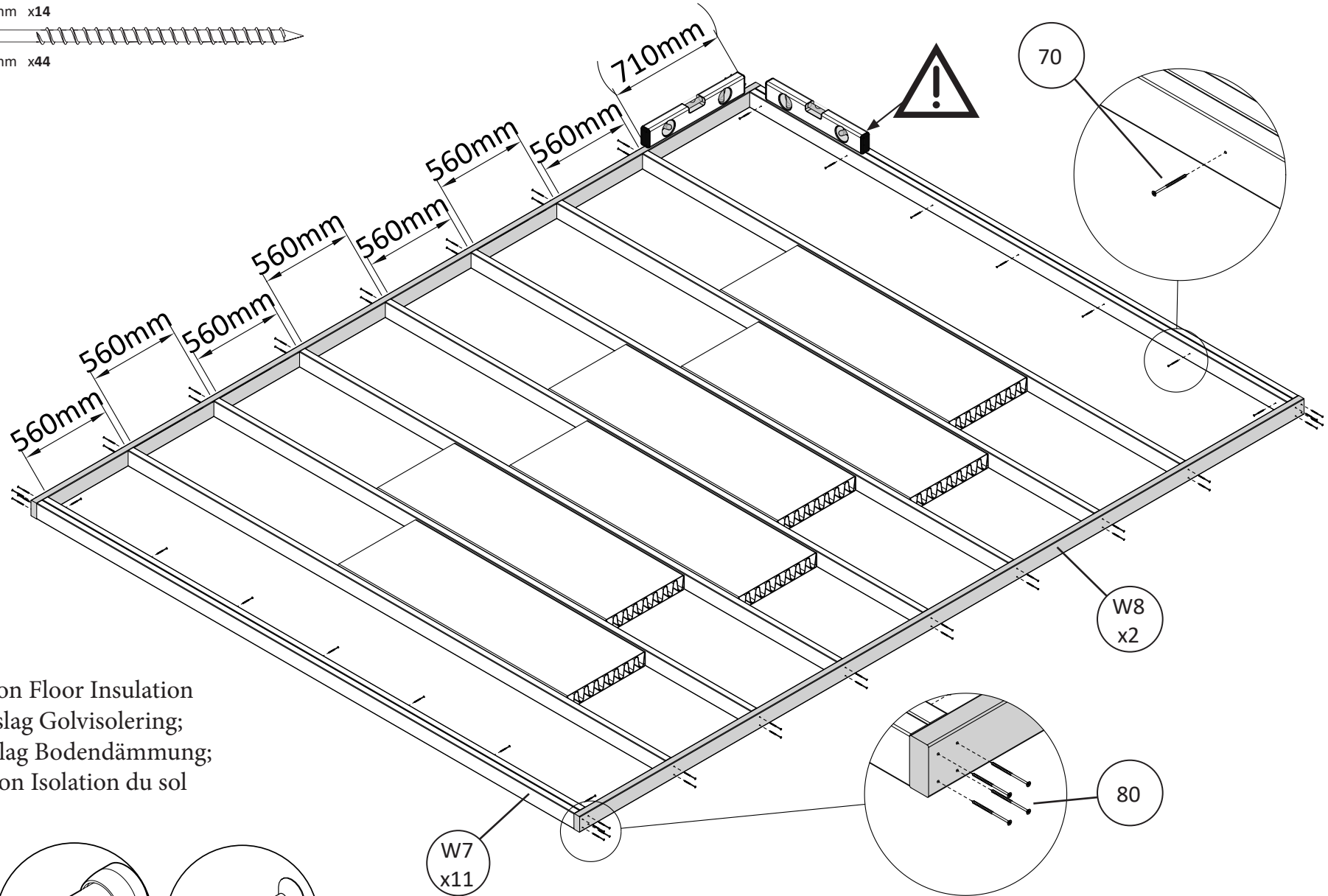

ENG; Option Floor Insulation
SWE: Förslag Golvisolering;
GER: Vorschlag Bodendämmung;
FRA: Option Isolation du sol

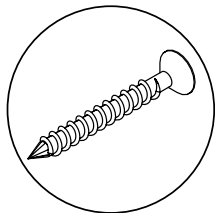
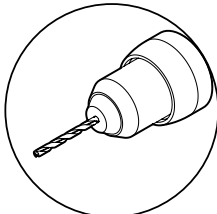
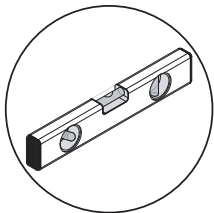

2

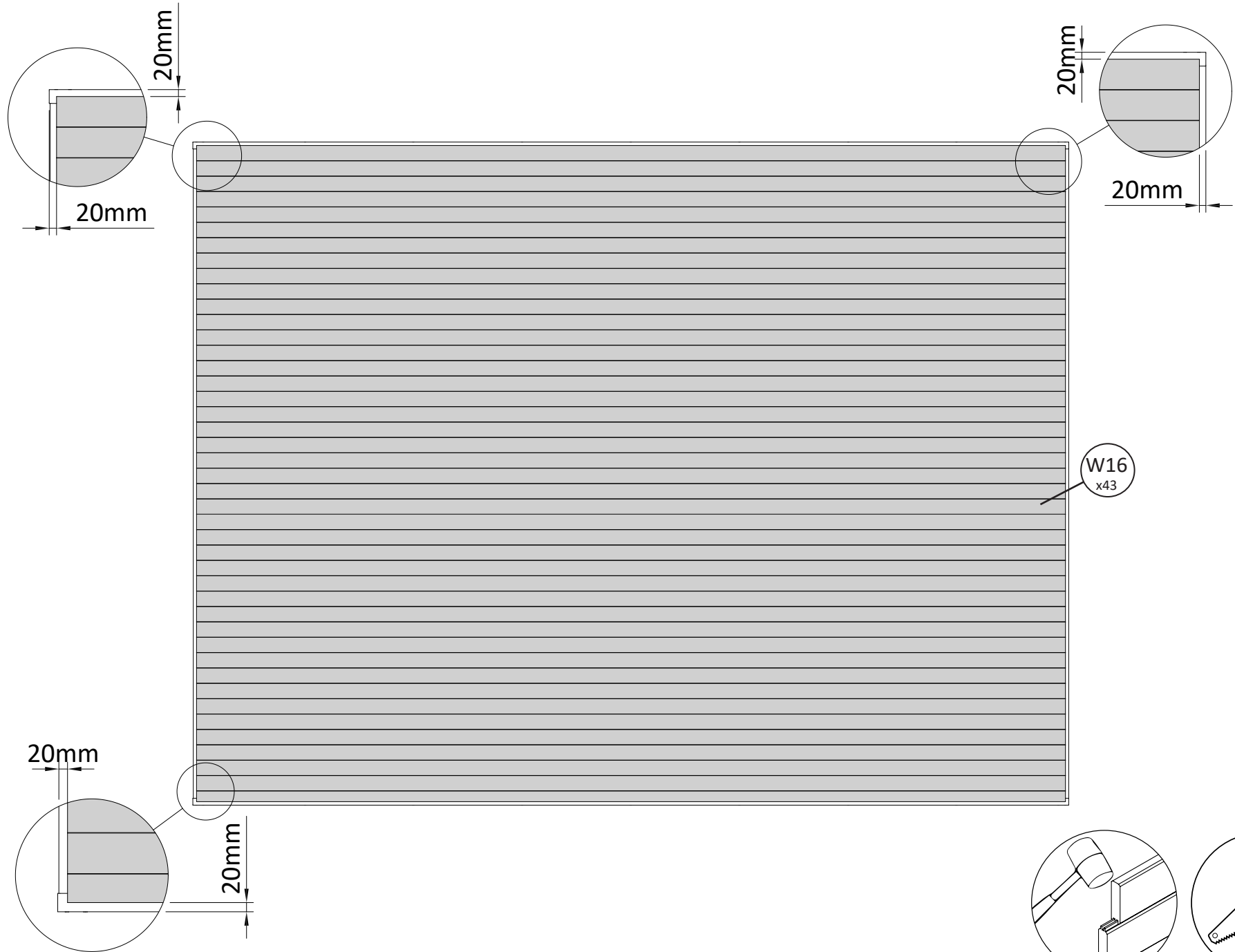

3

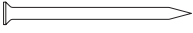
Pin x387 

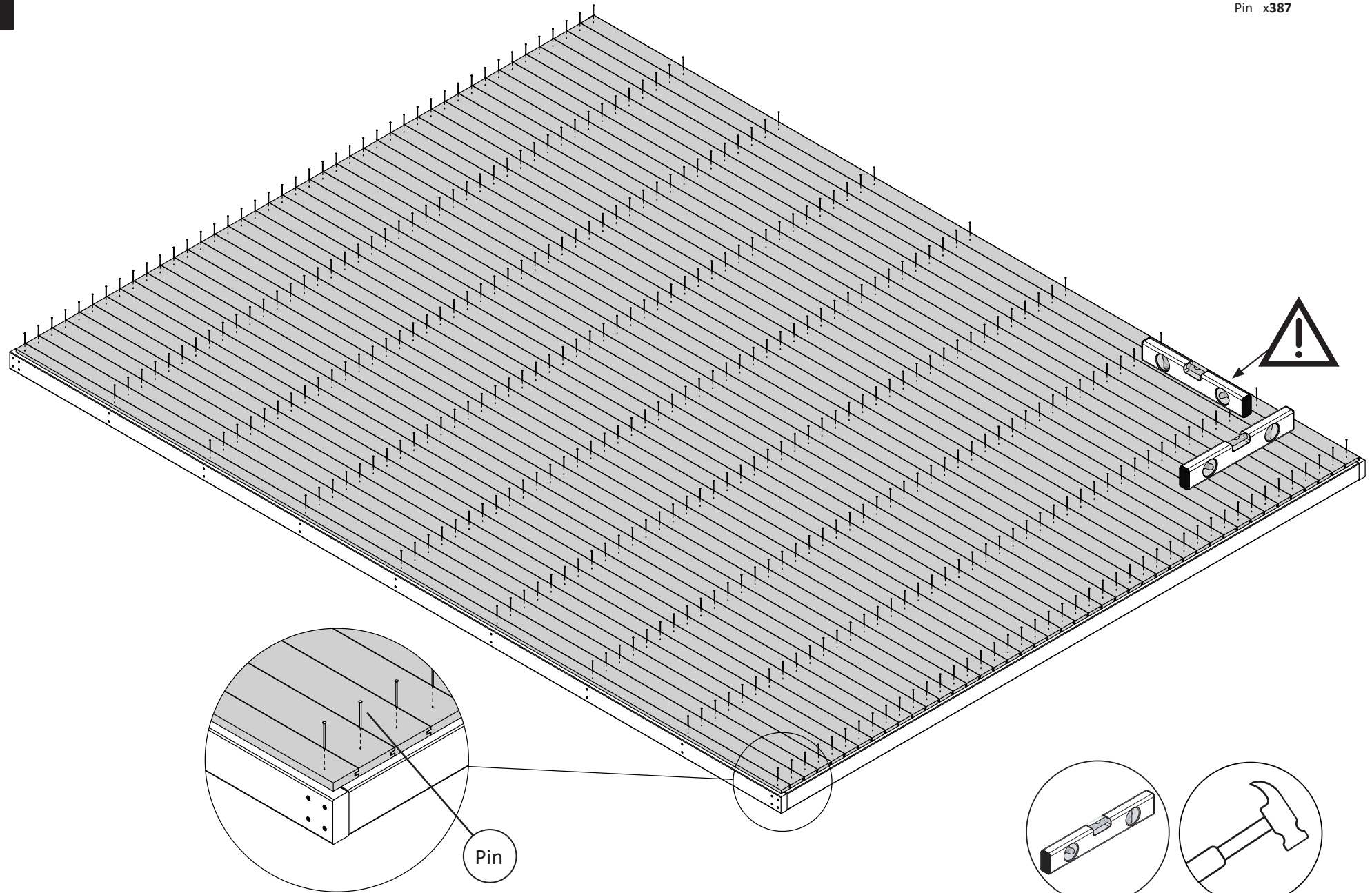

4

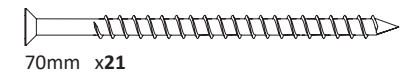
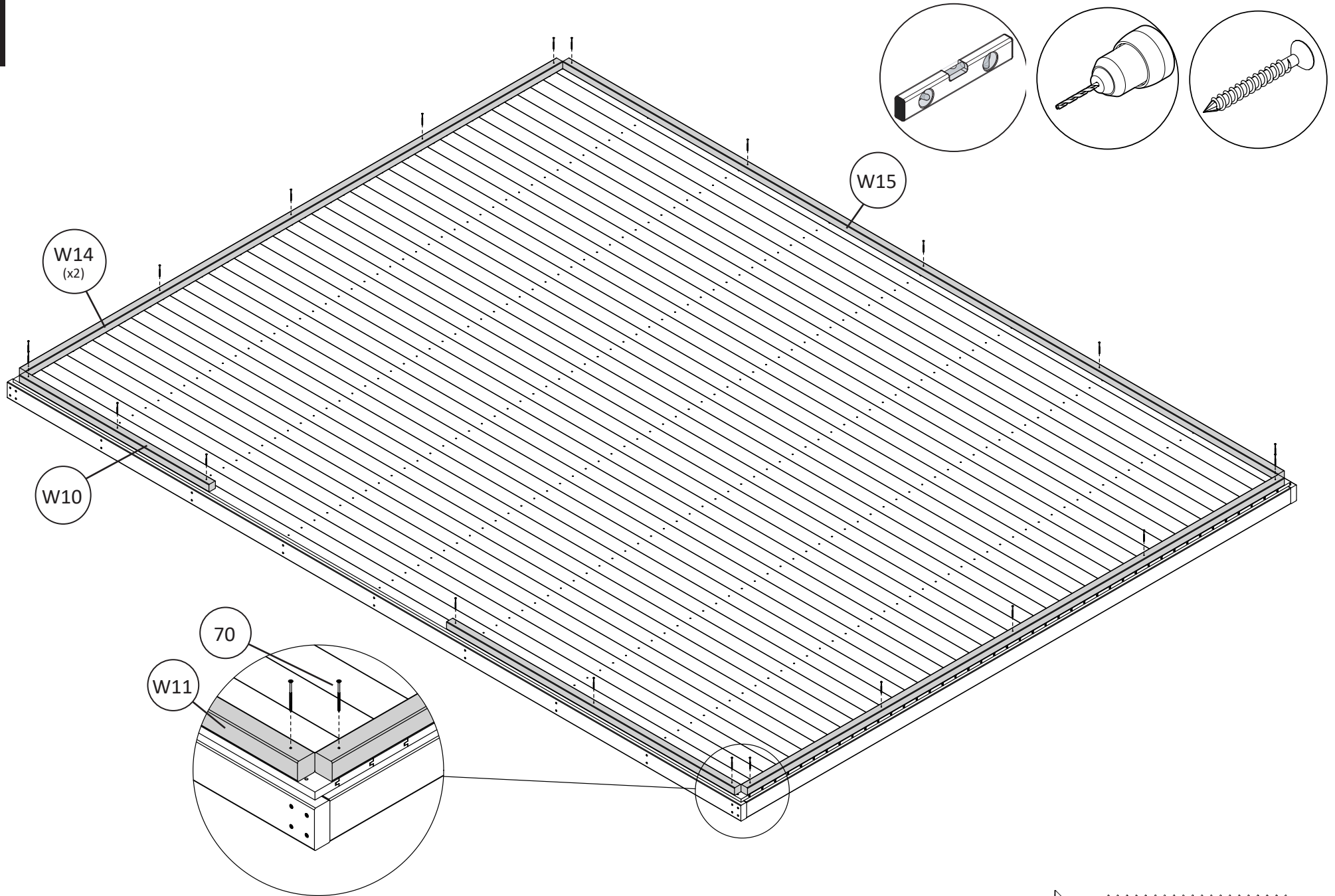

5

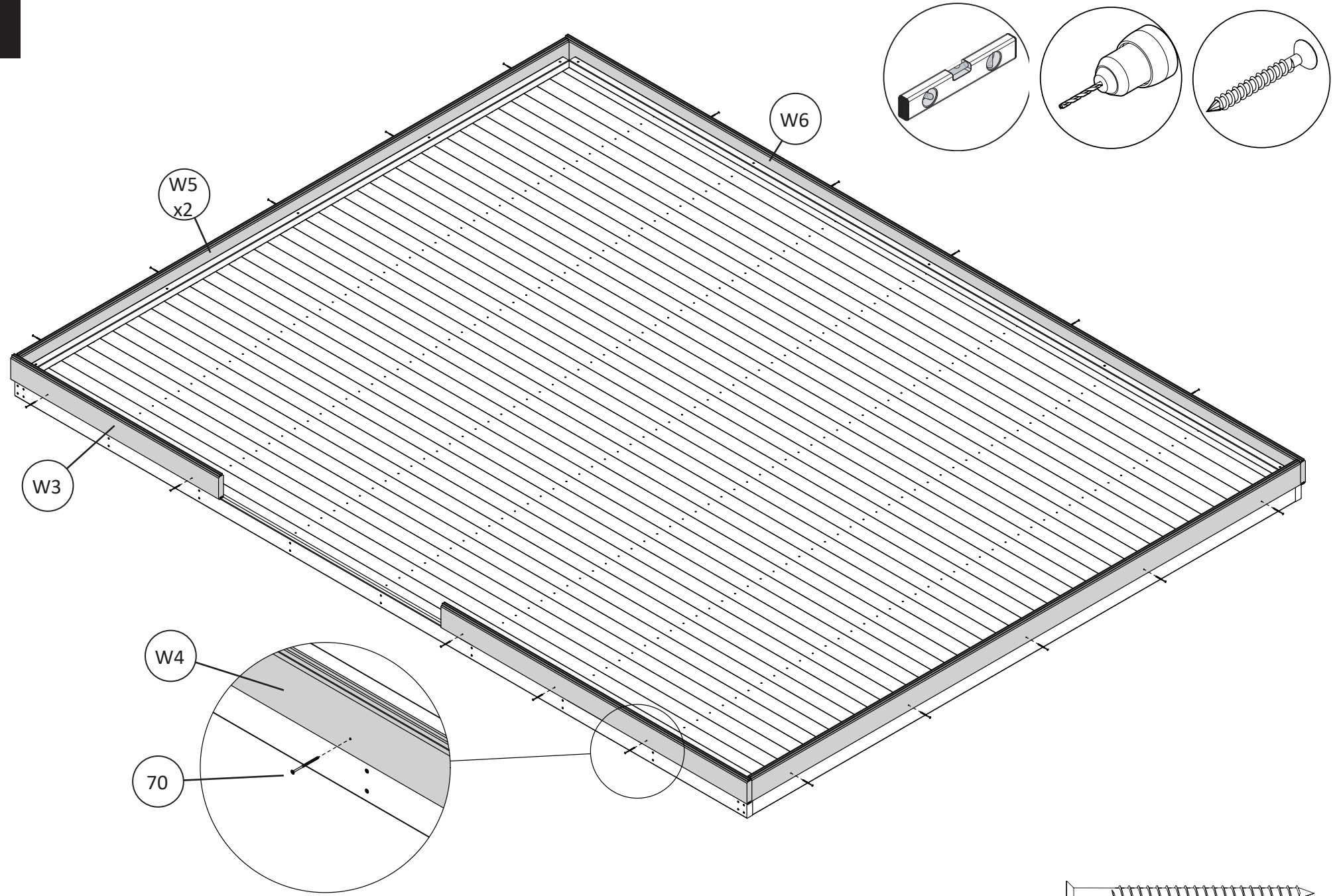

6

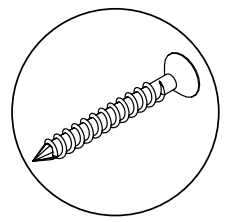
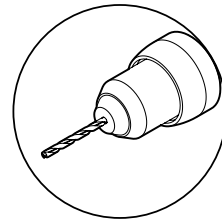
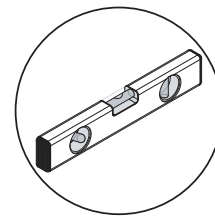
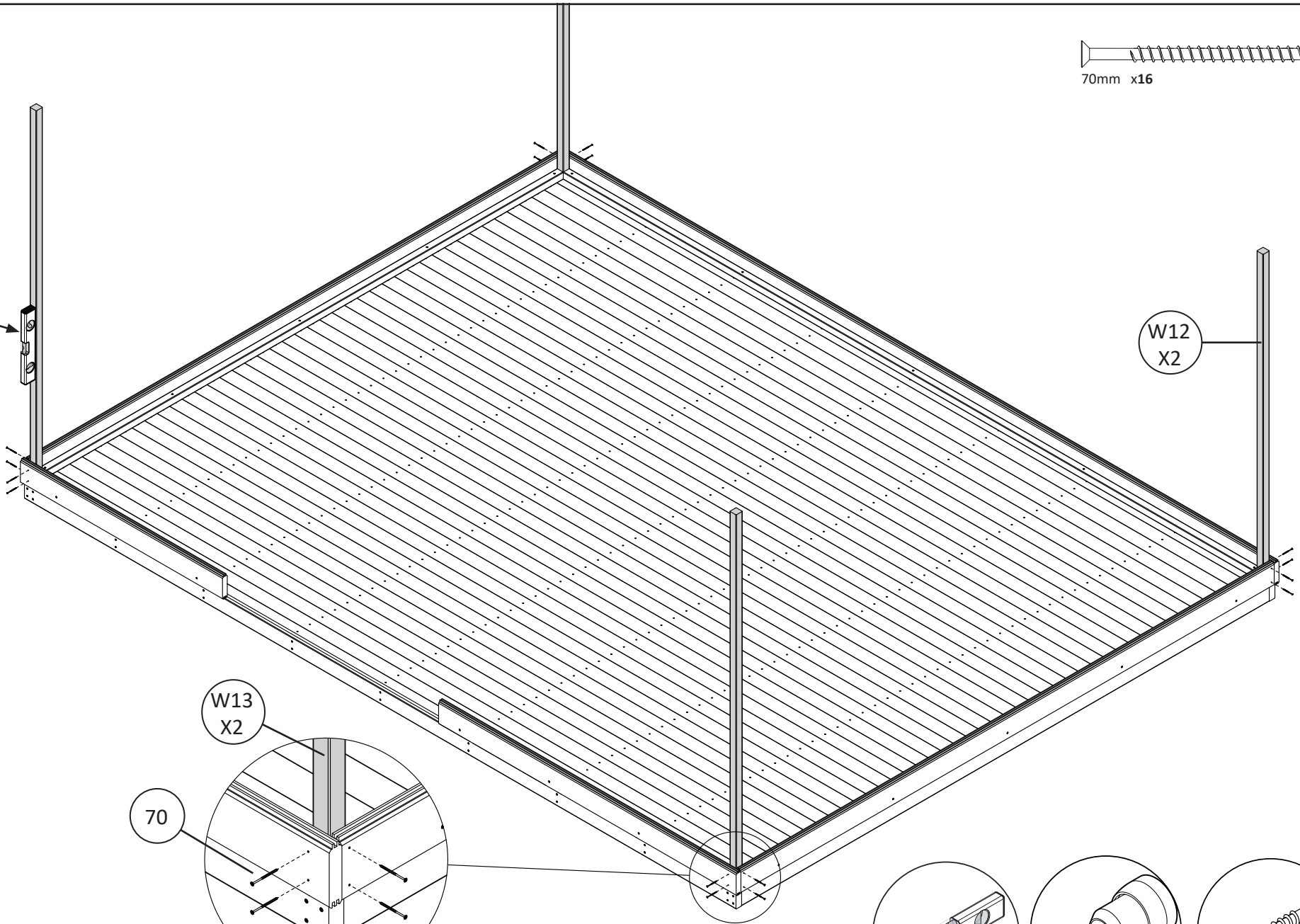
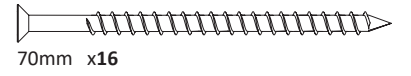

7

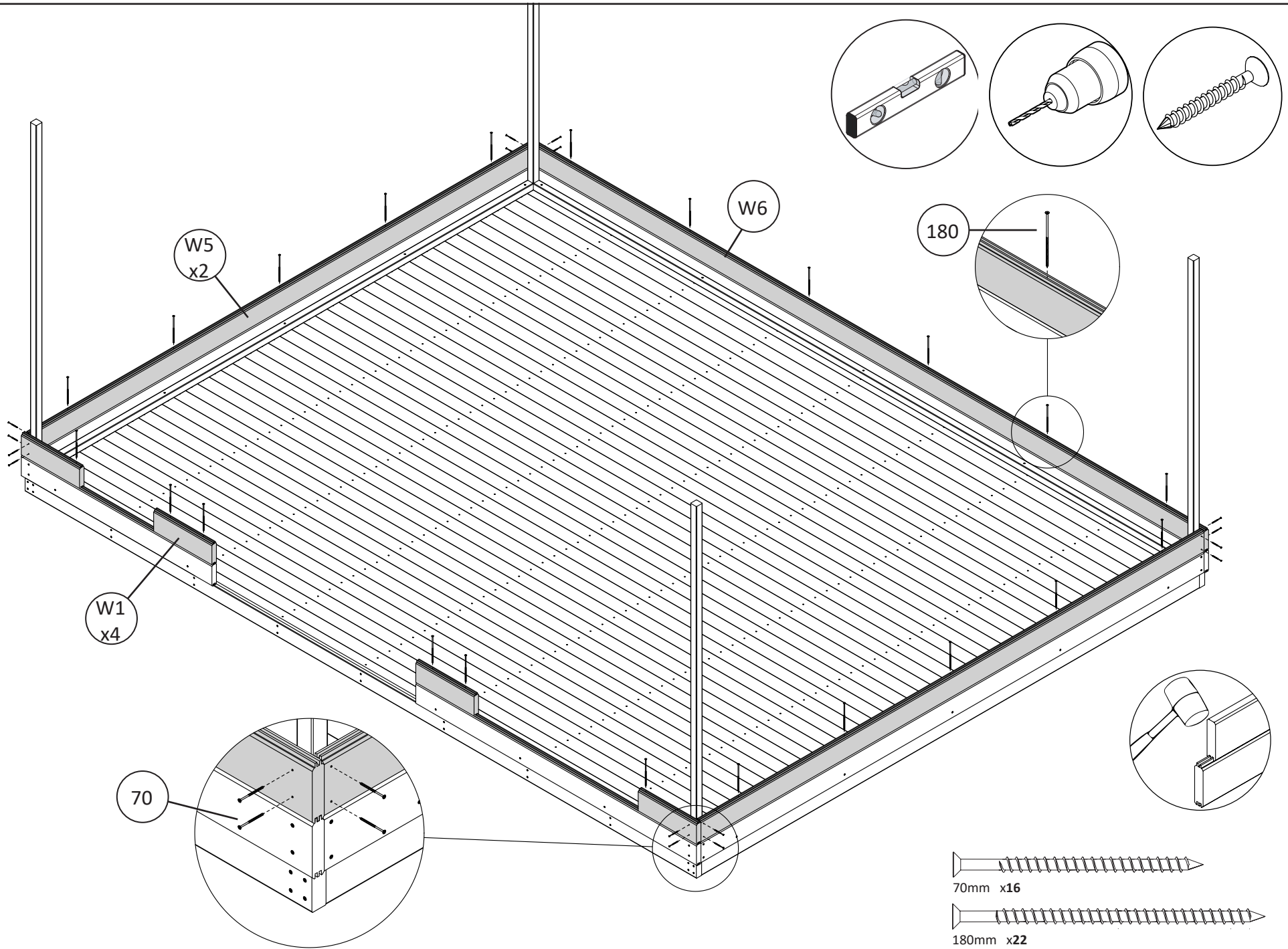

8

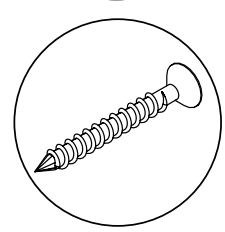
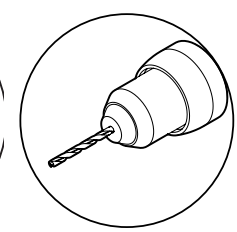
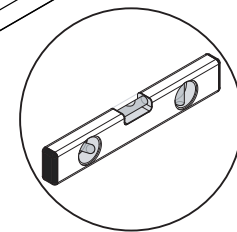
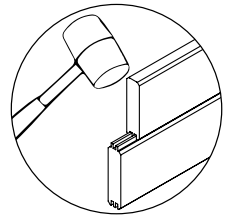
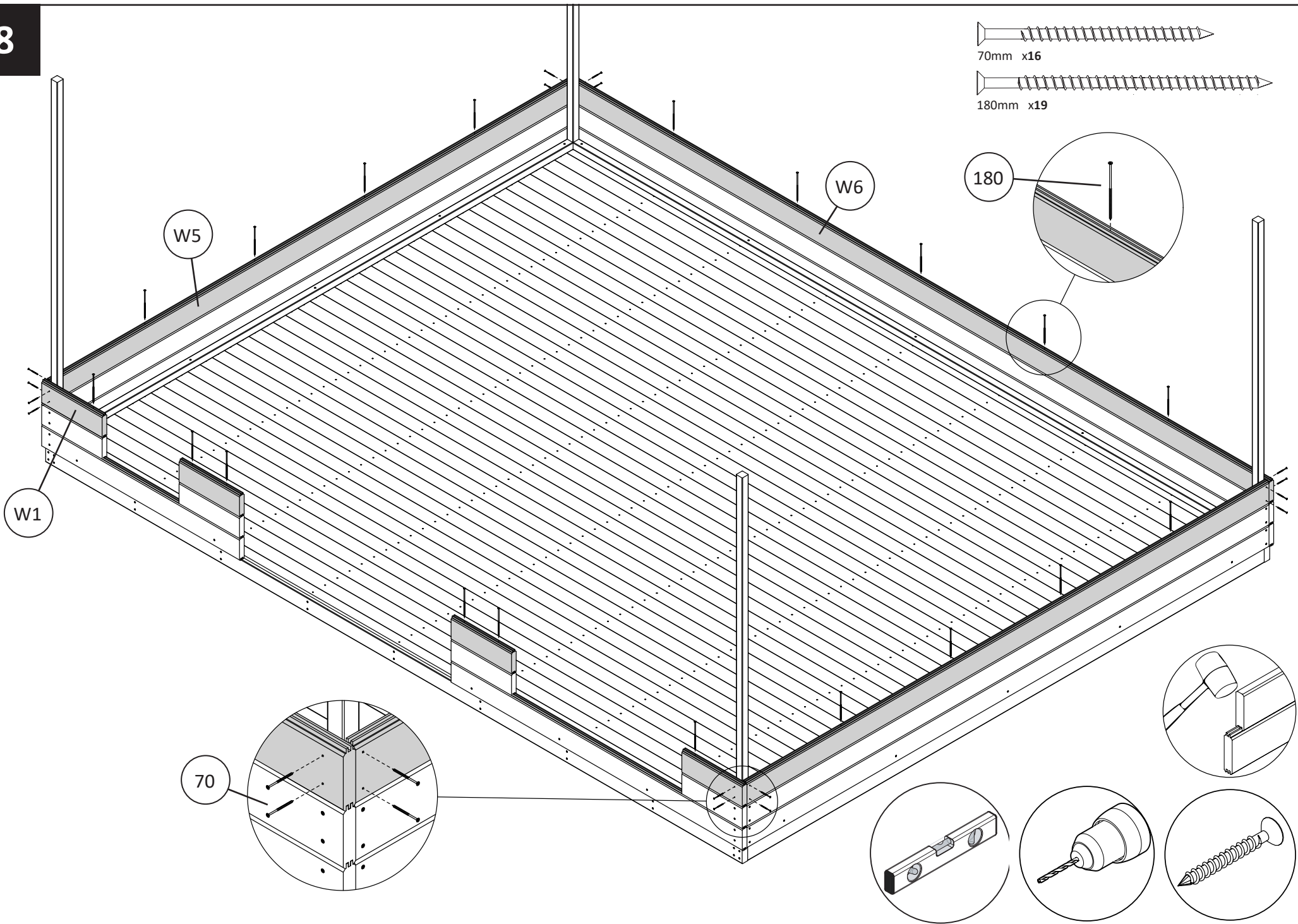
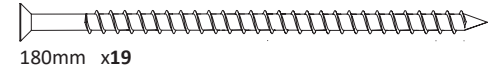
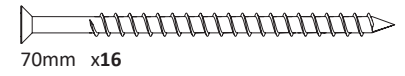

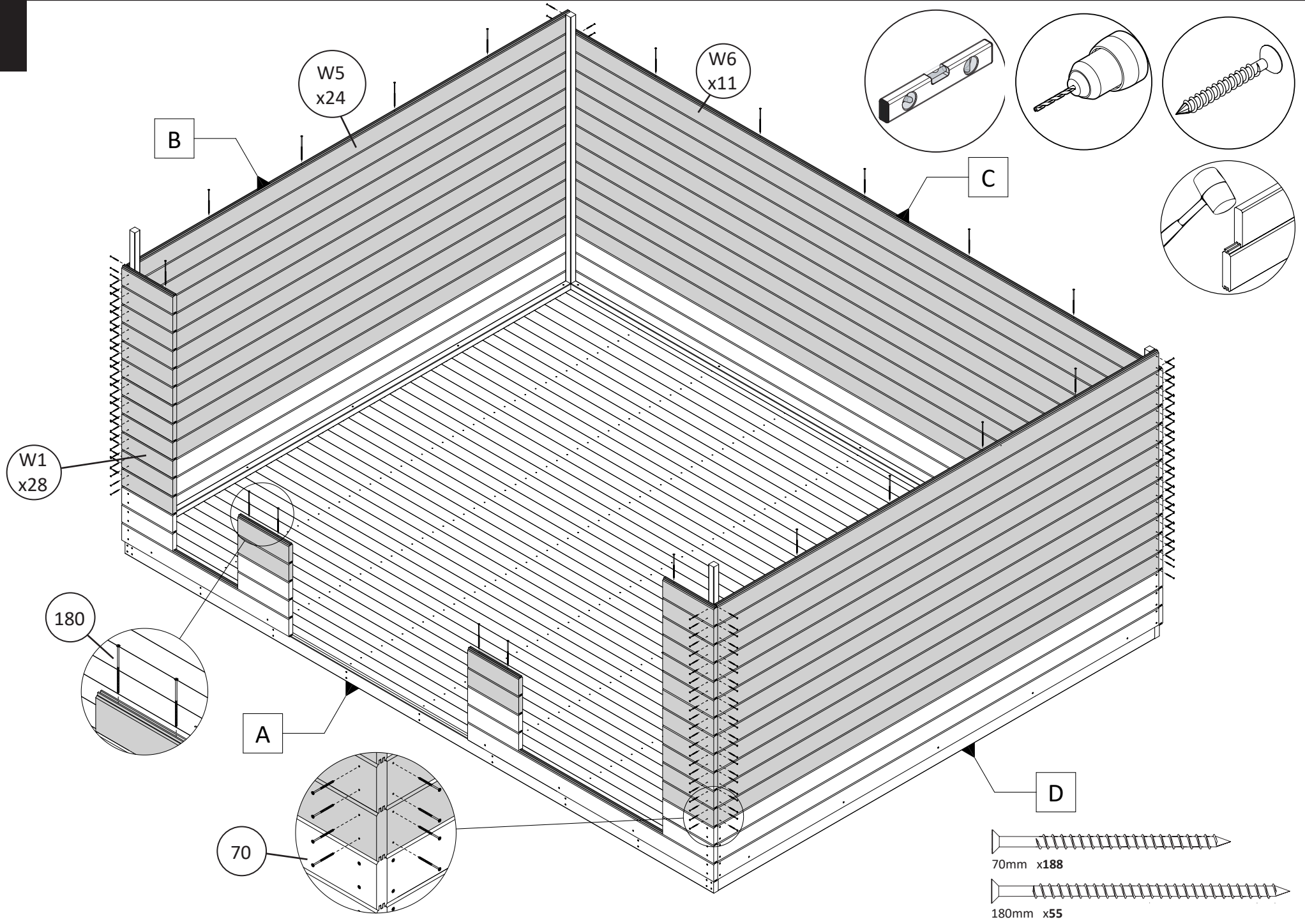

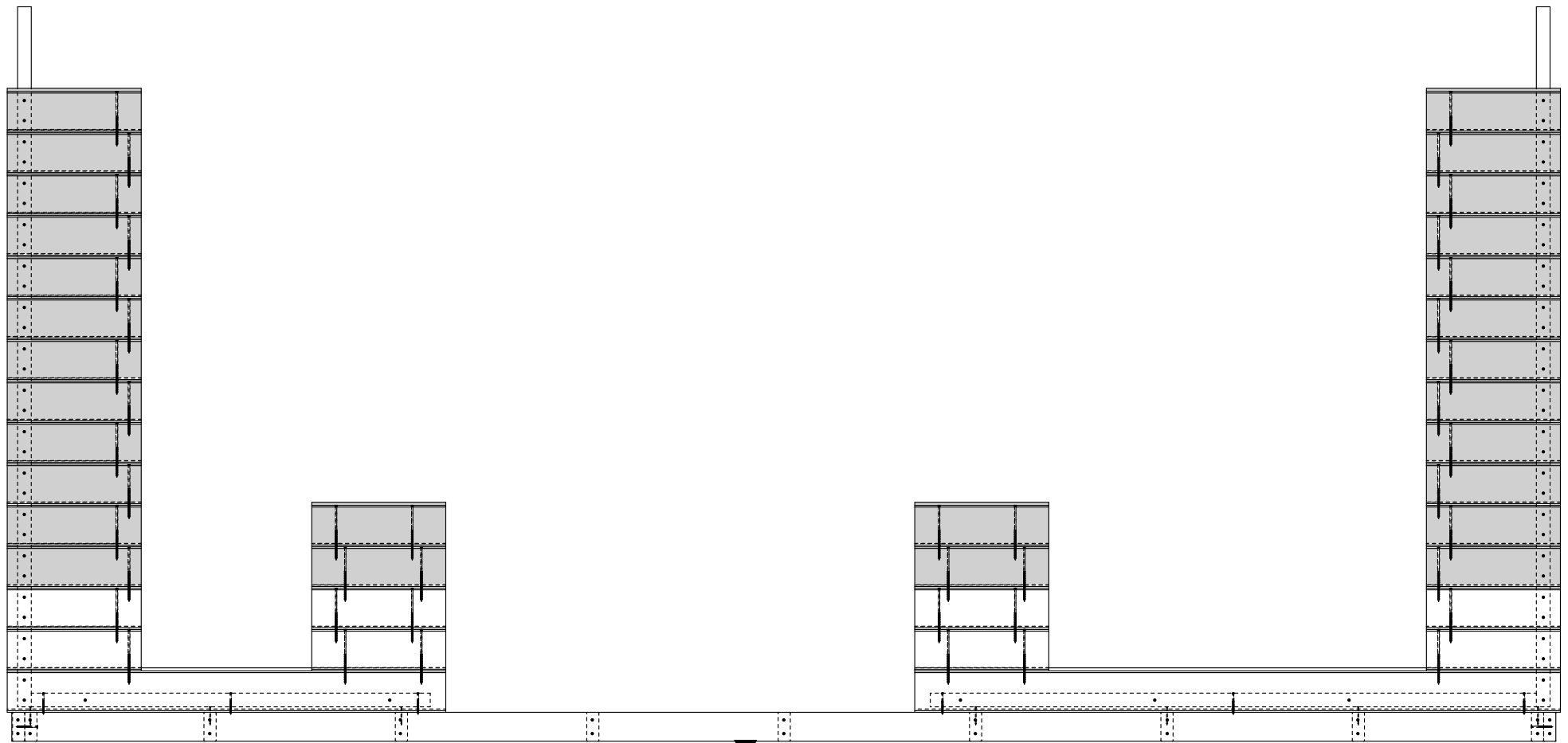

A

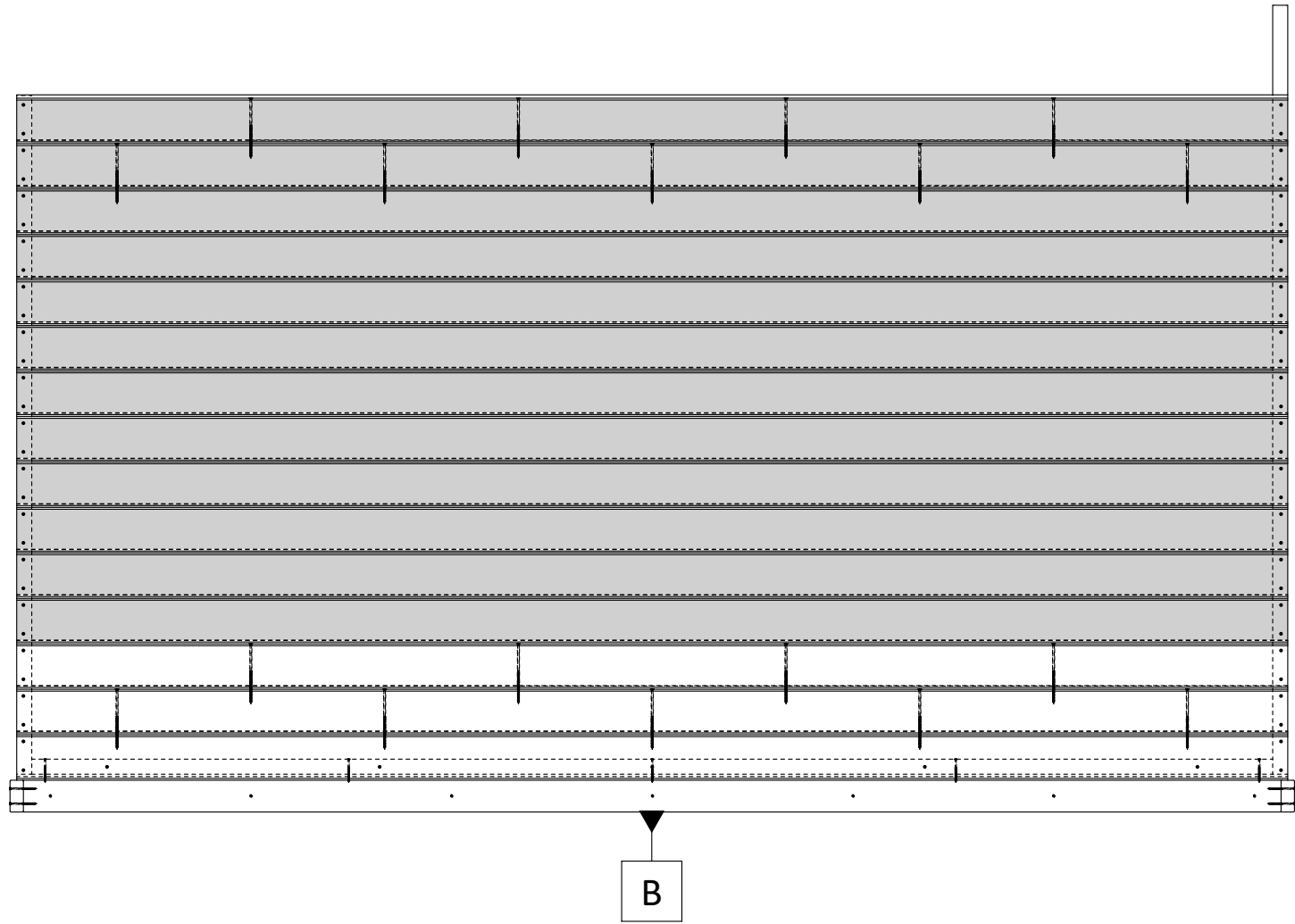

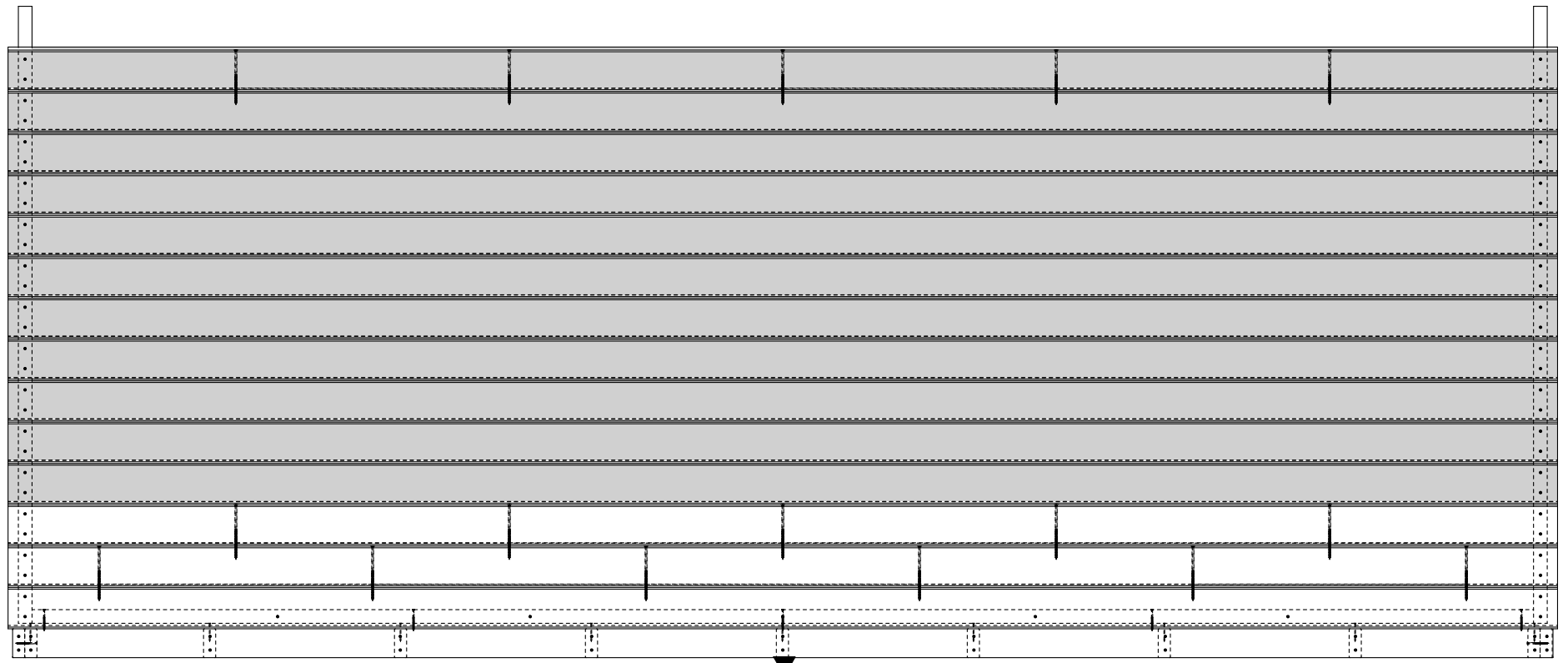

C

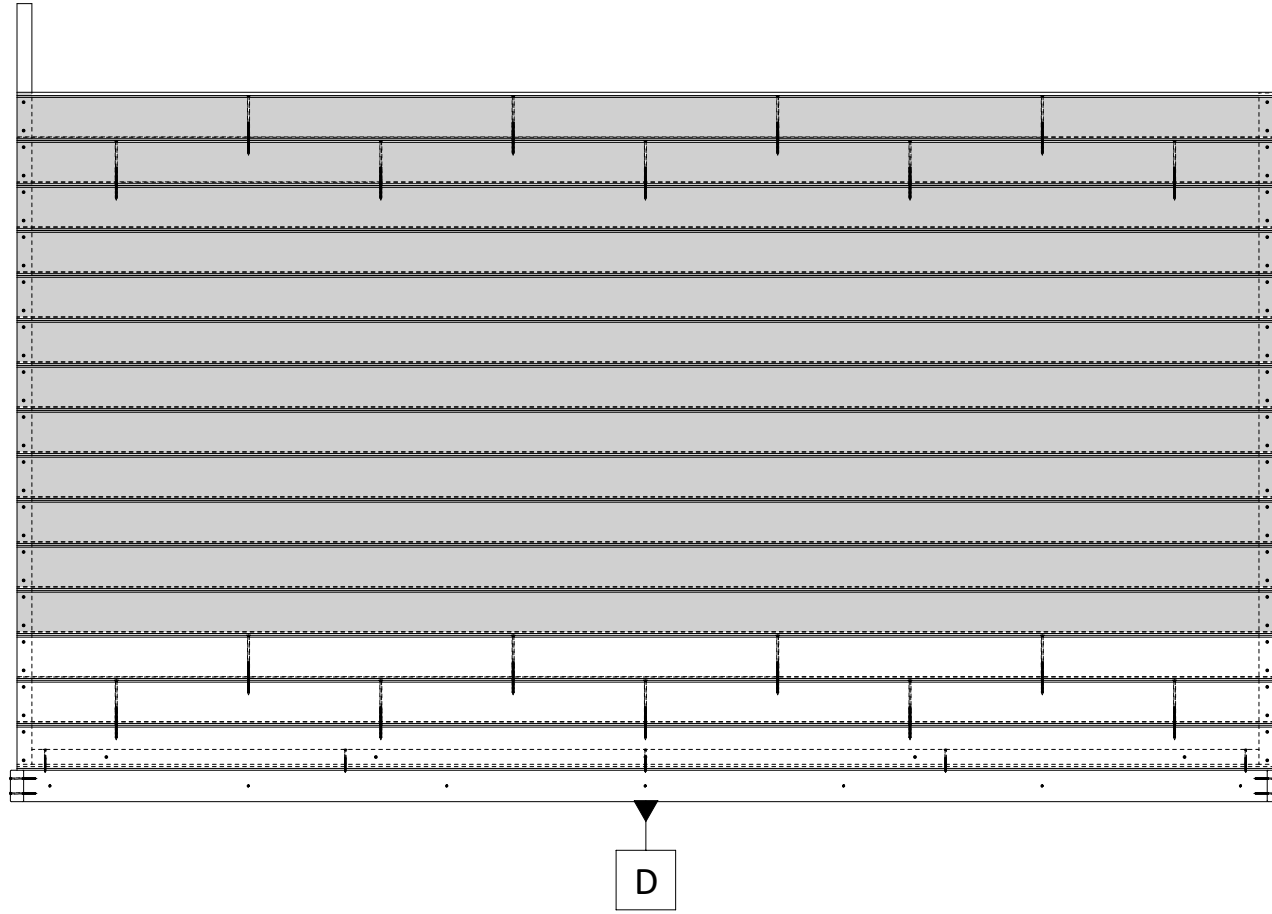

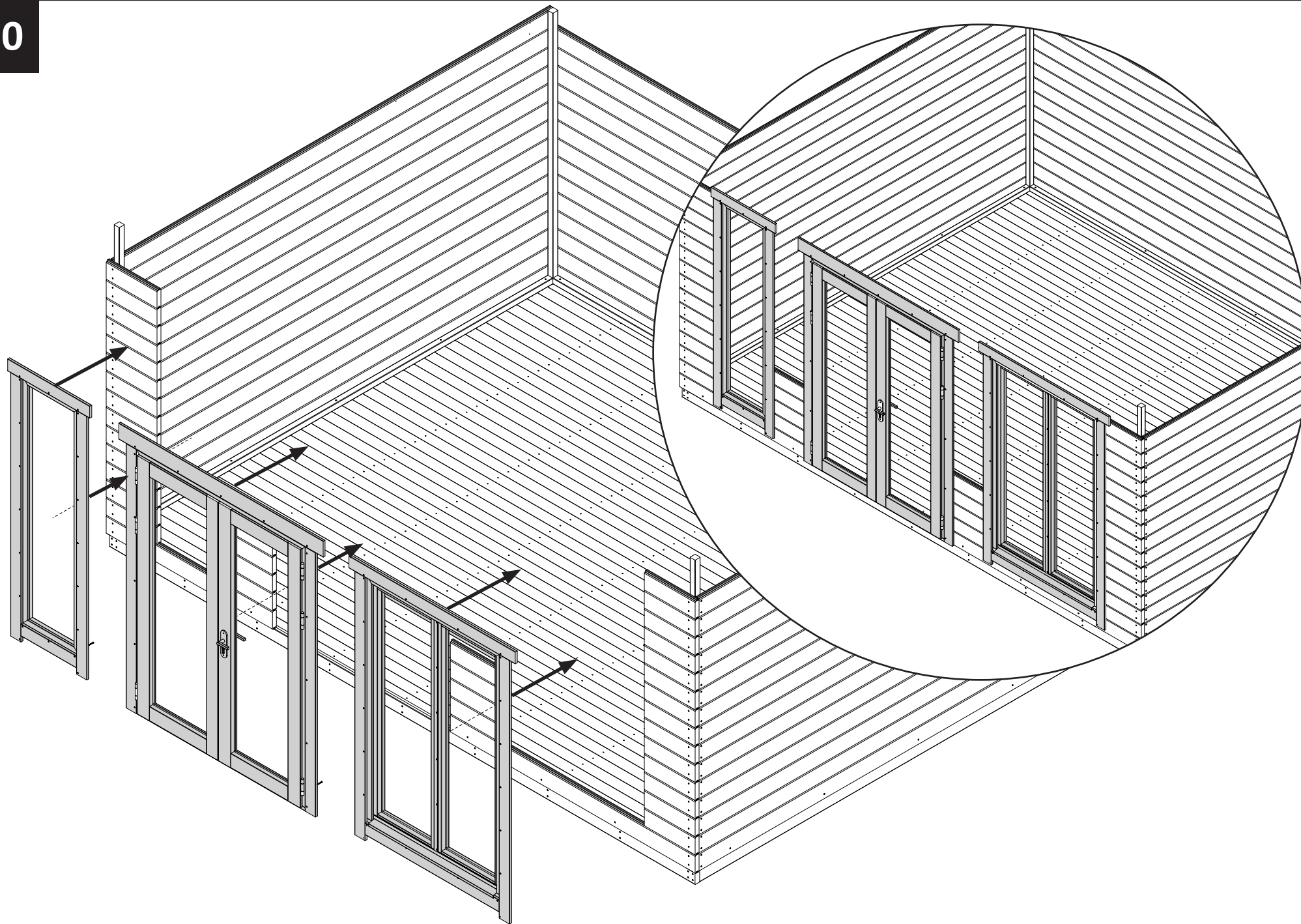

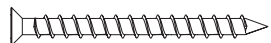

50mm x12

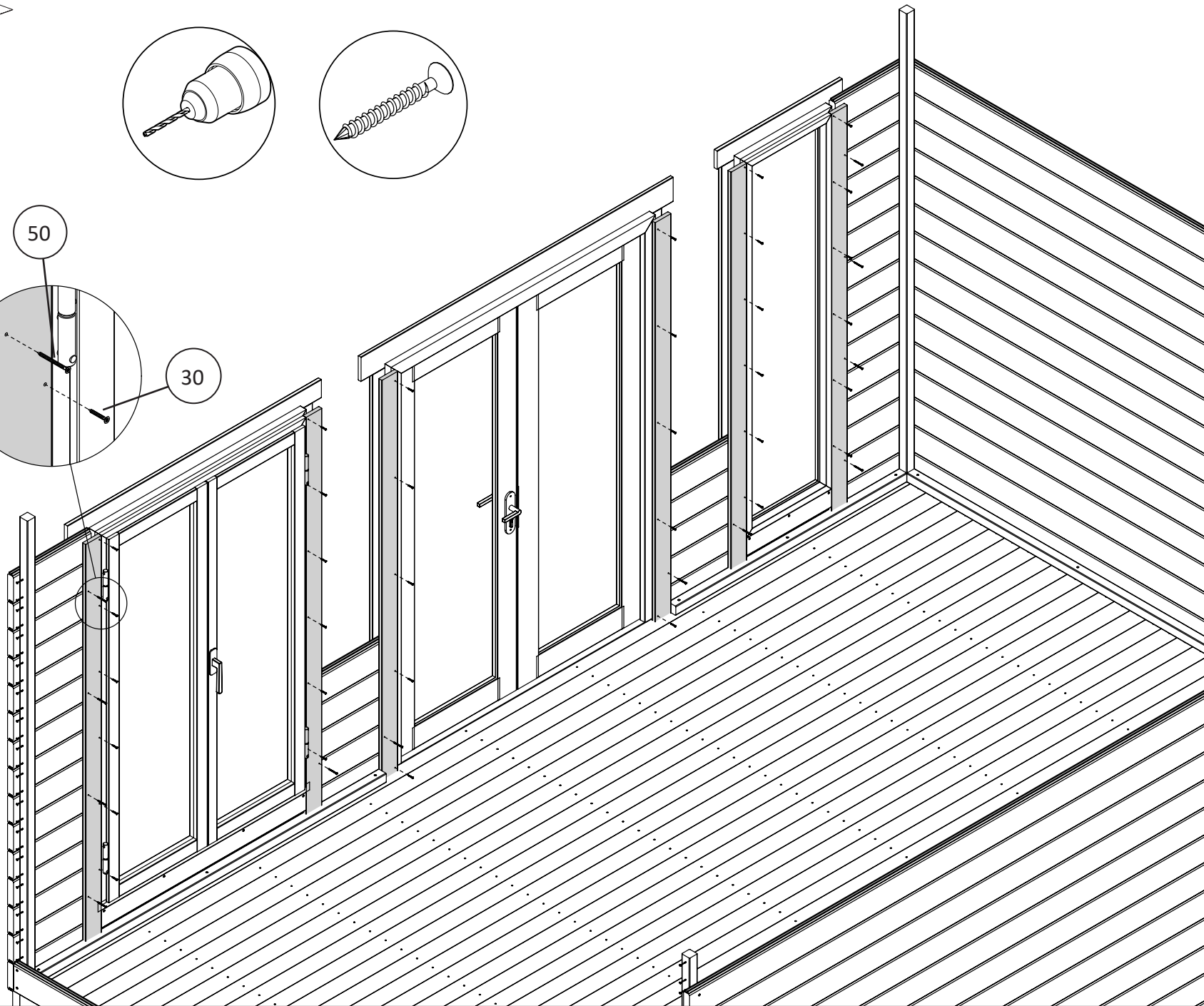
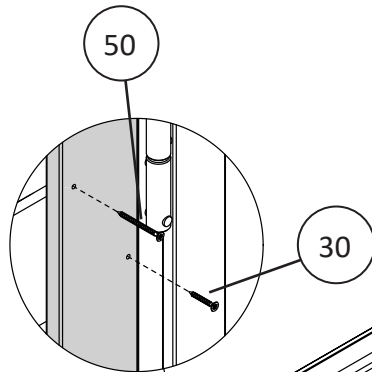
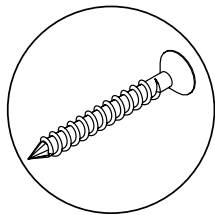
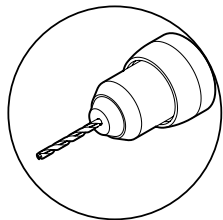

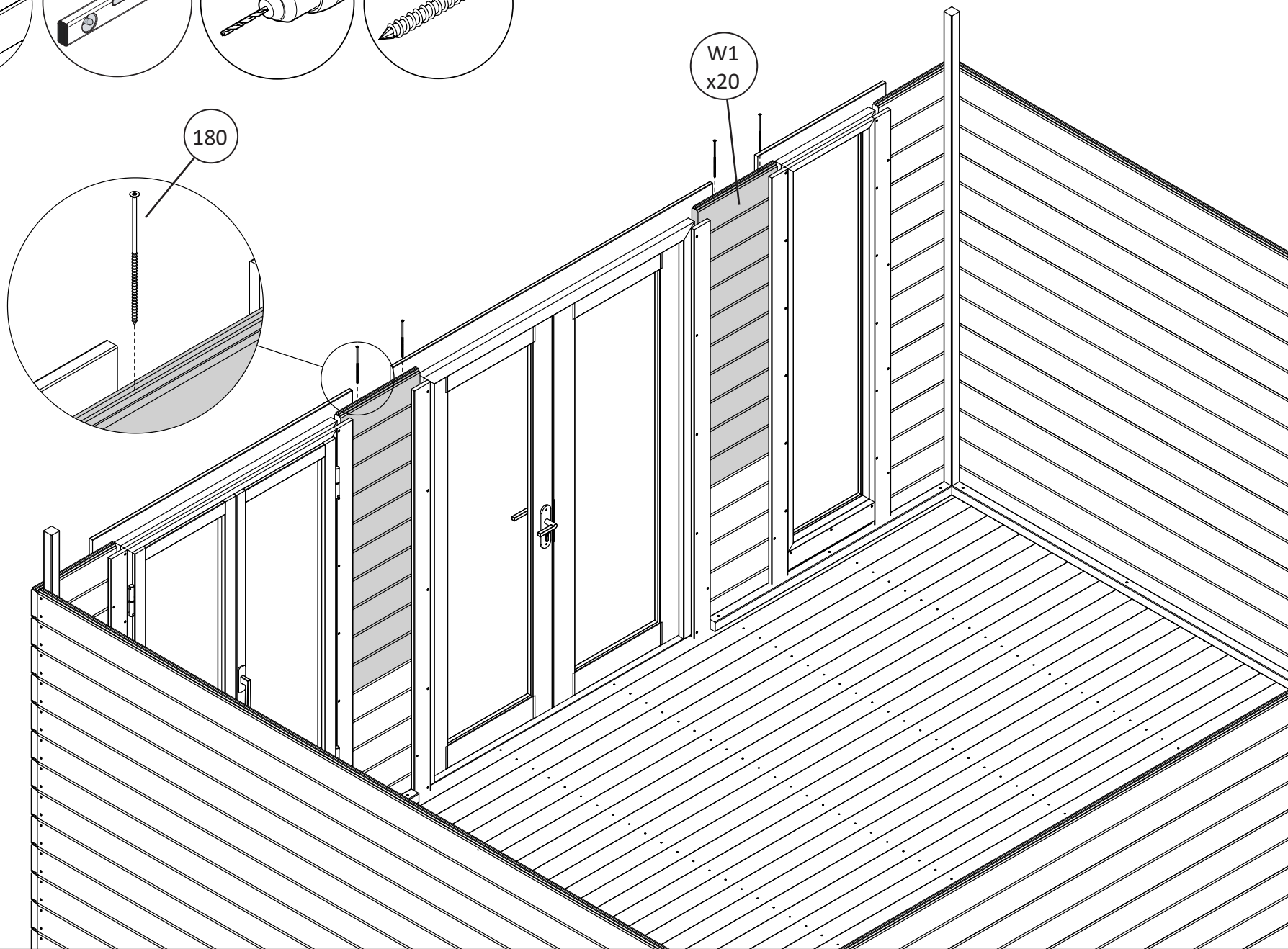
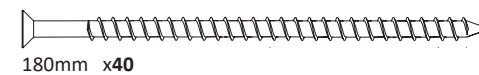
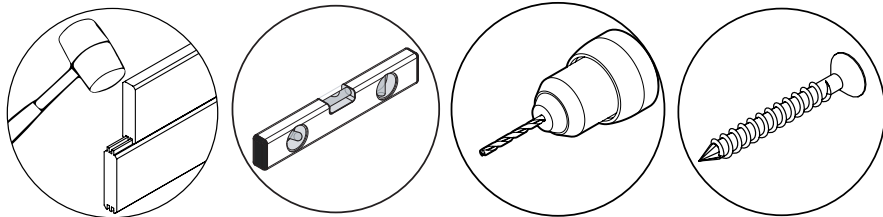

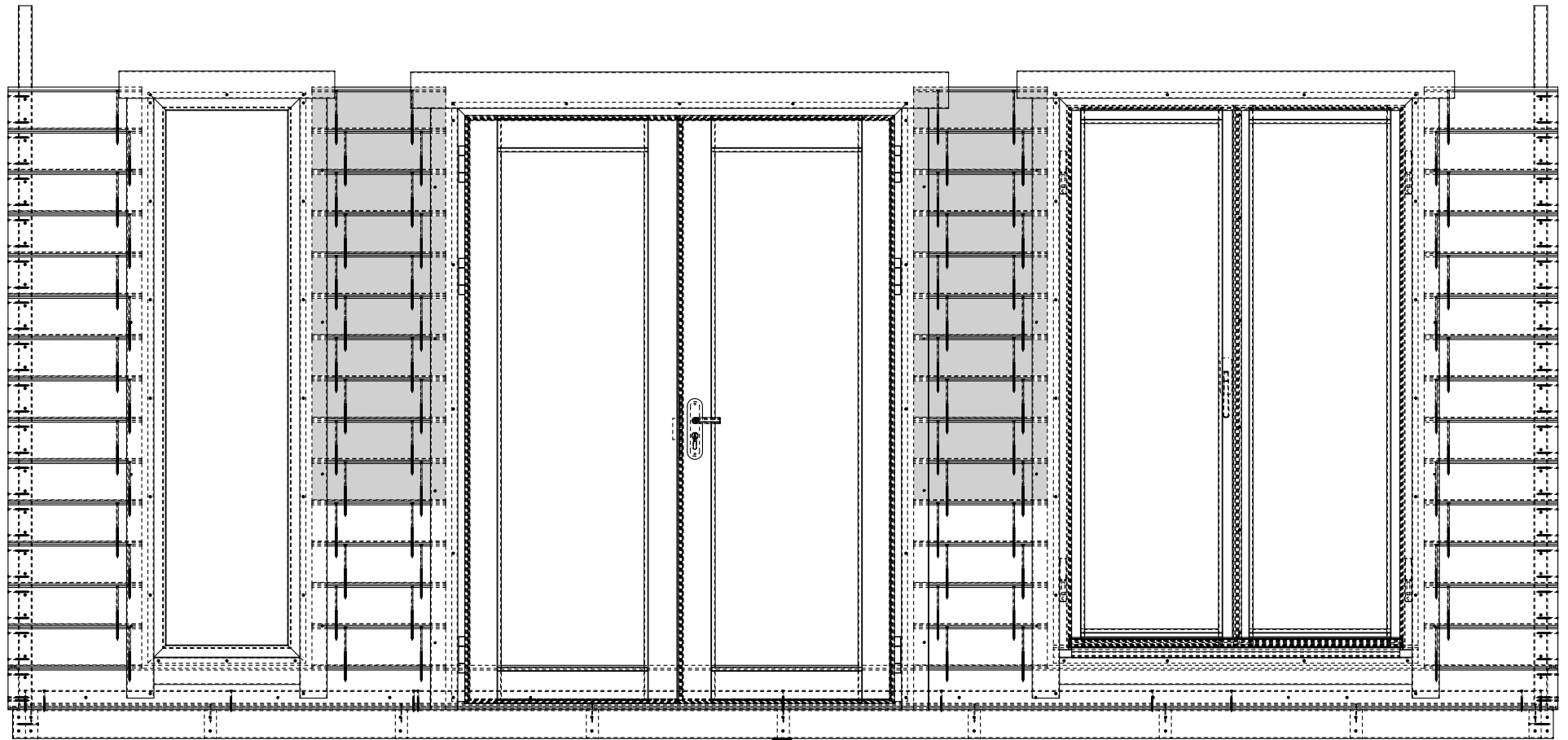

A

13

50mm x12

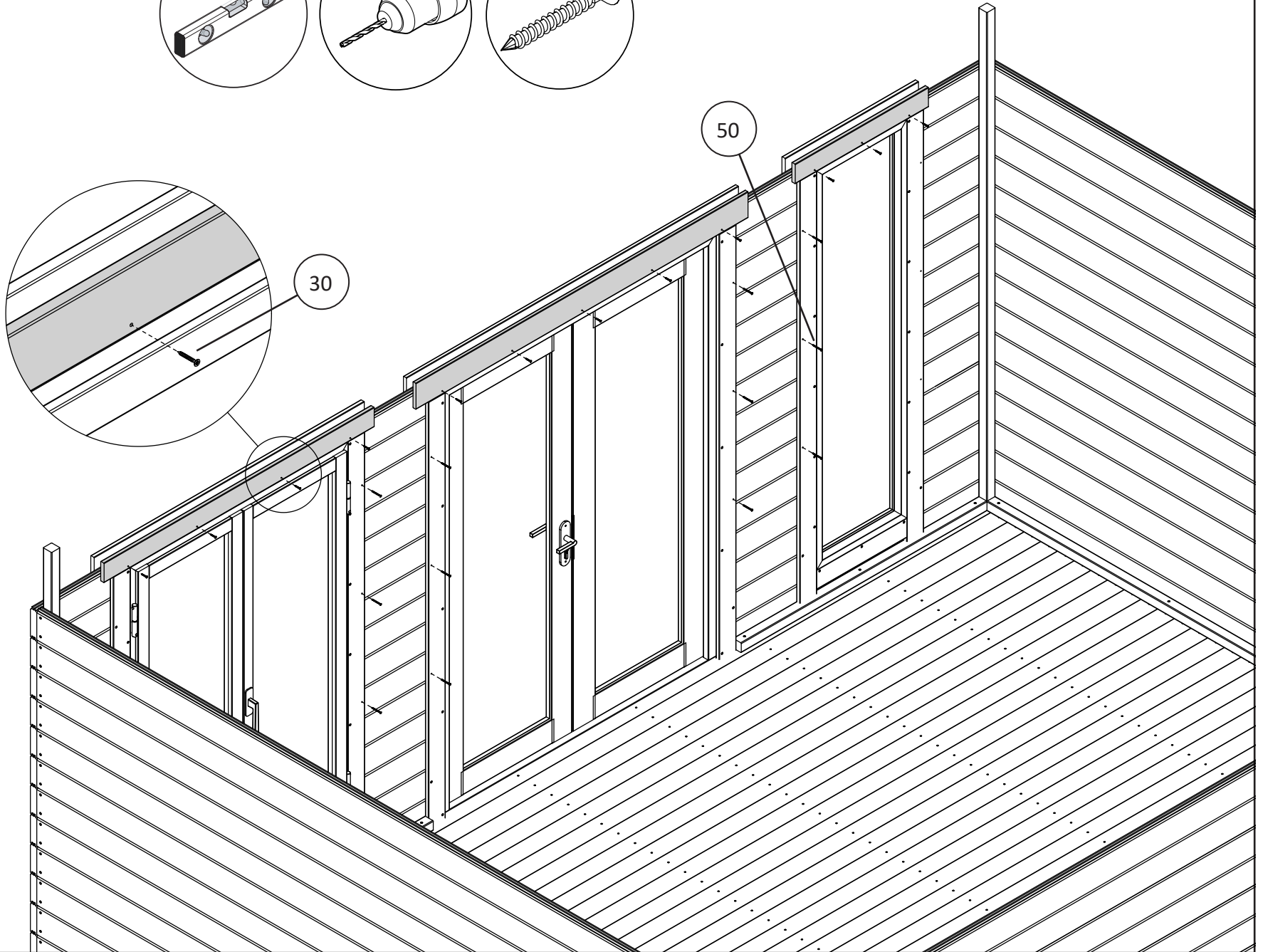
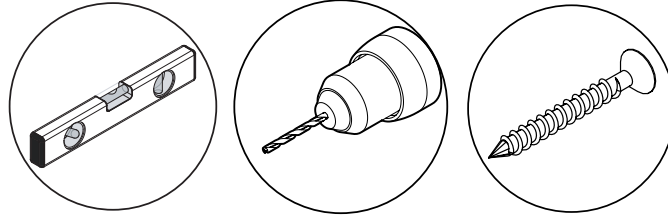

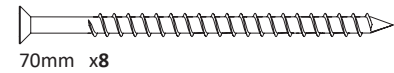

70mm x8

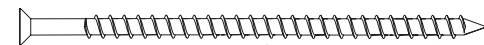

180mm x14

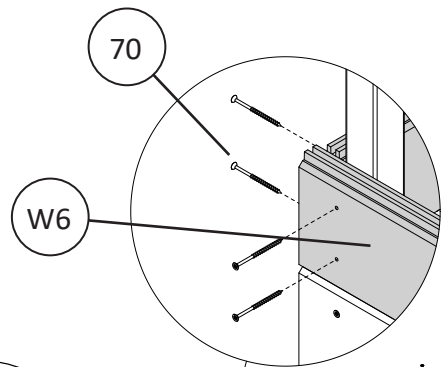

70

W6

W24
x2

180

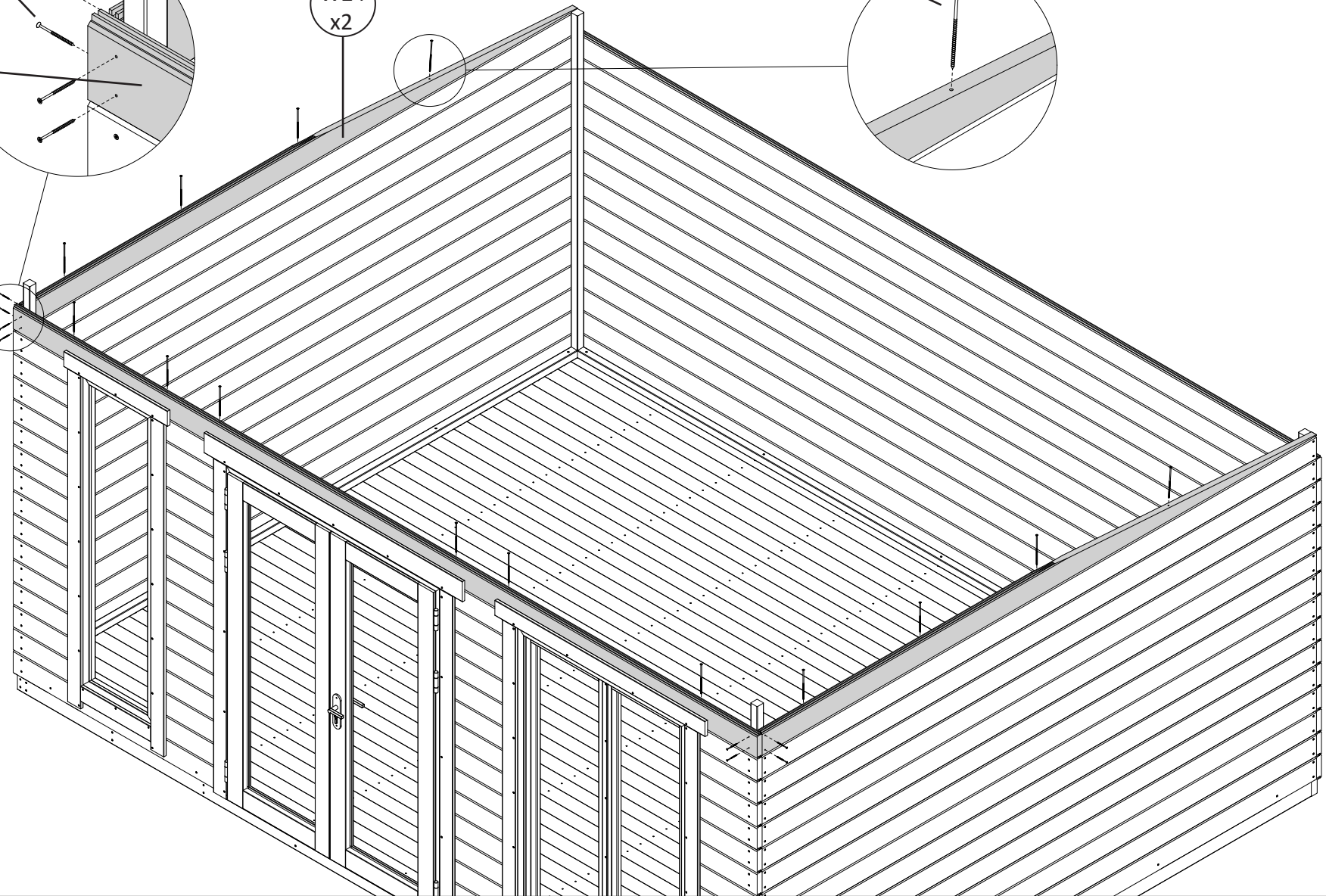
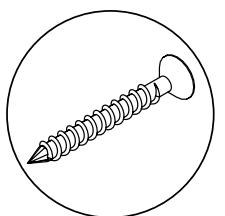
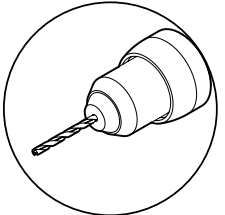
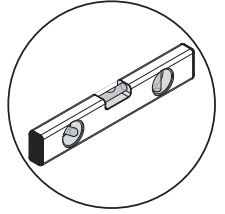
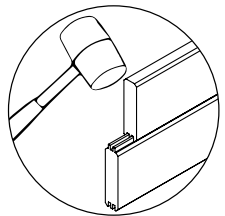
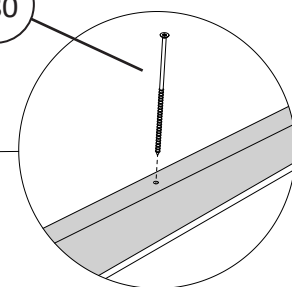



70mm x472

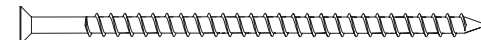

180mm x142

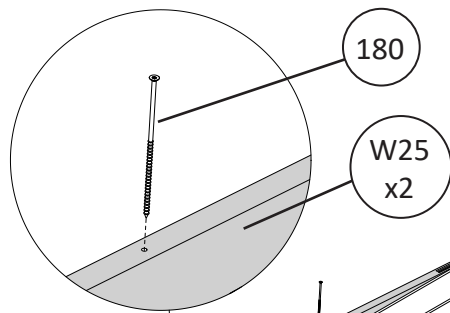

180

W25
x2

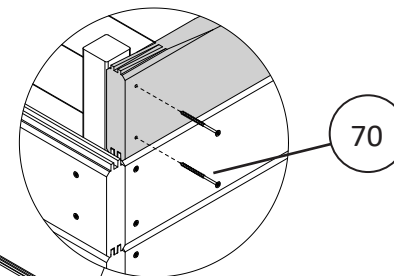

70

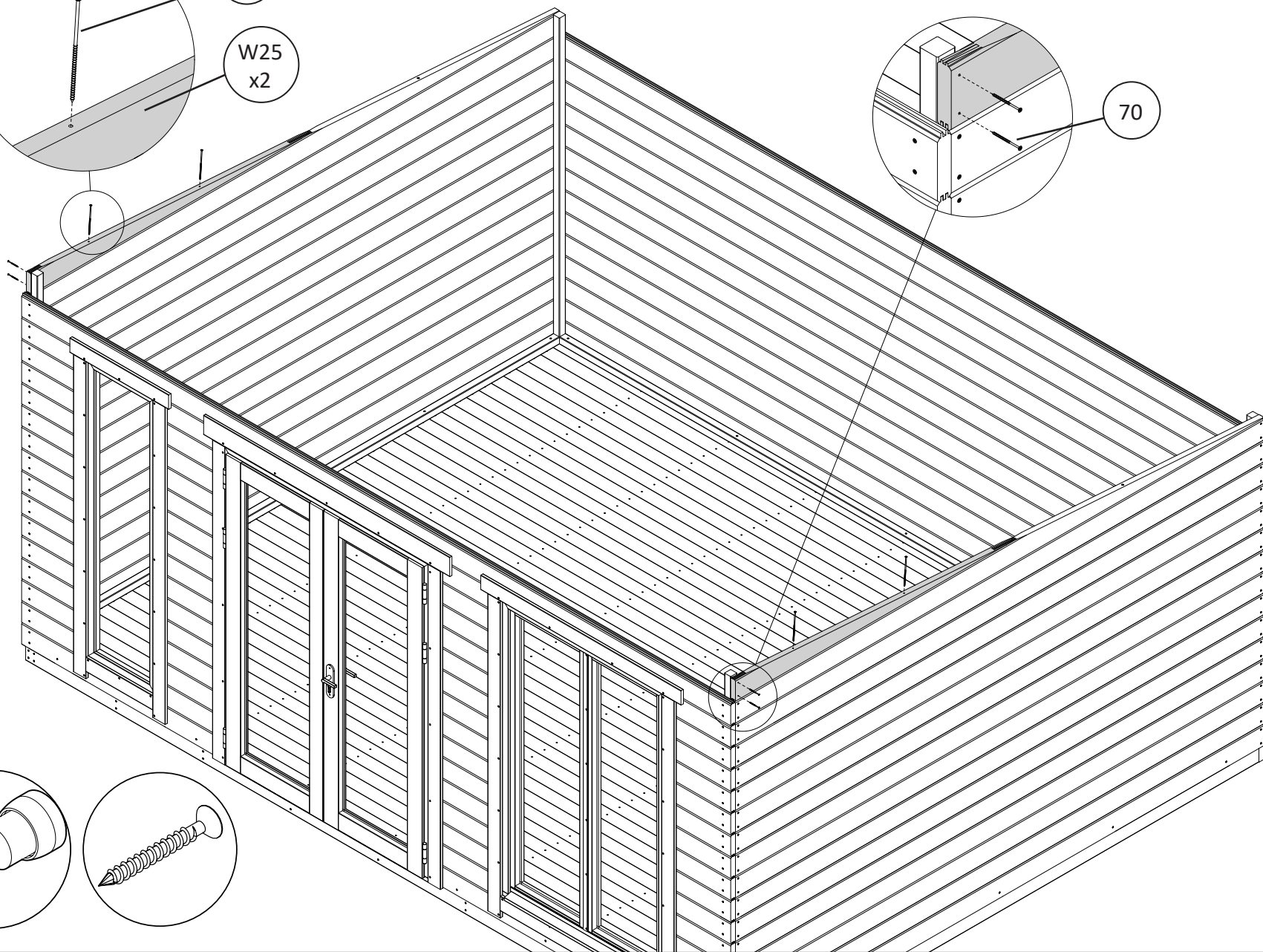
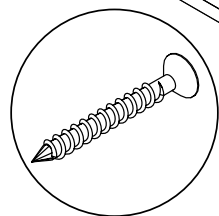
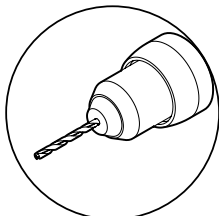
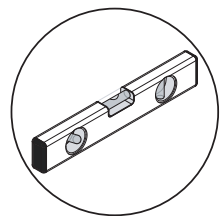
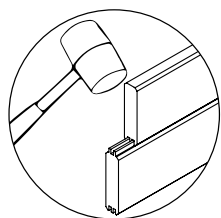

16

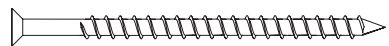

70mm x8



180mm x28

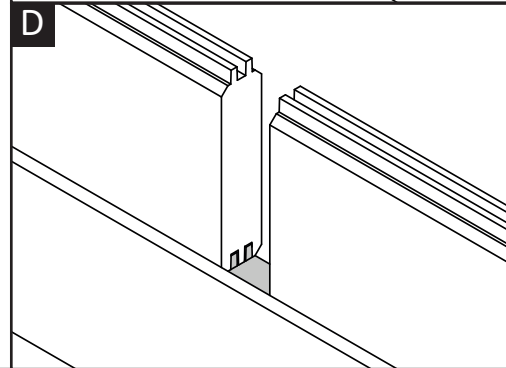
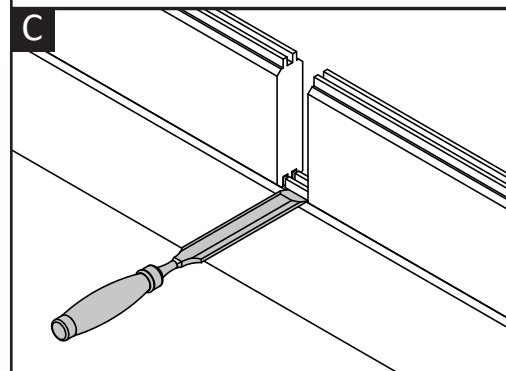
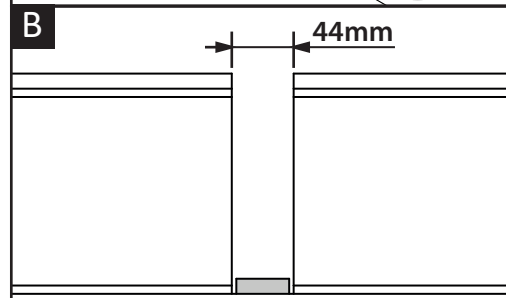
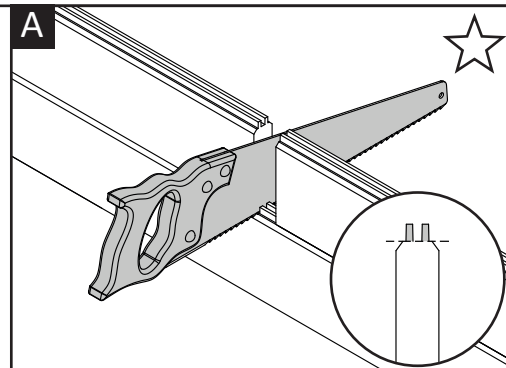
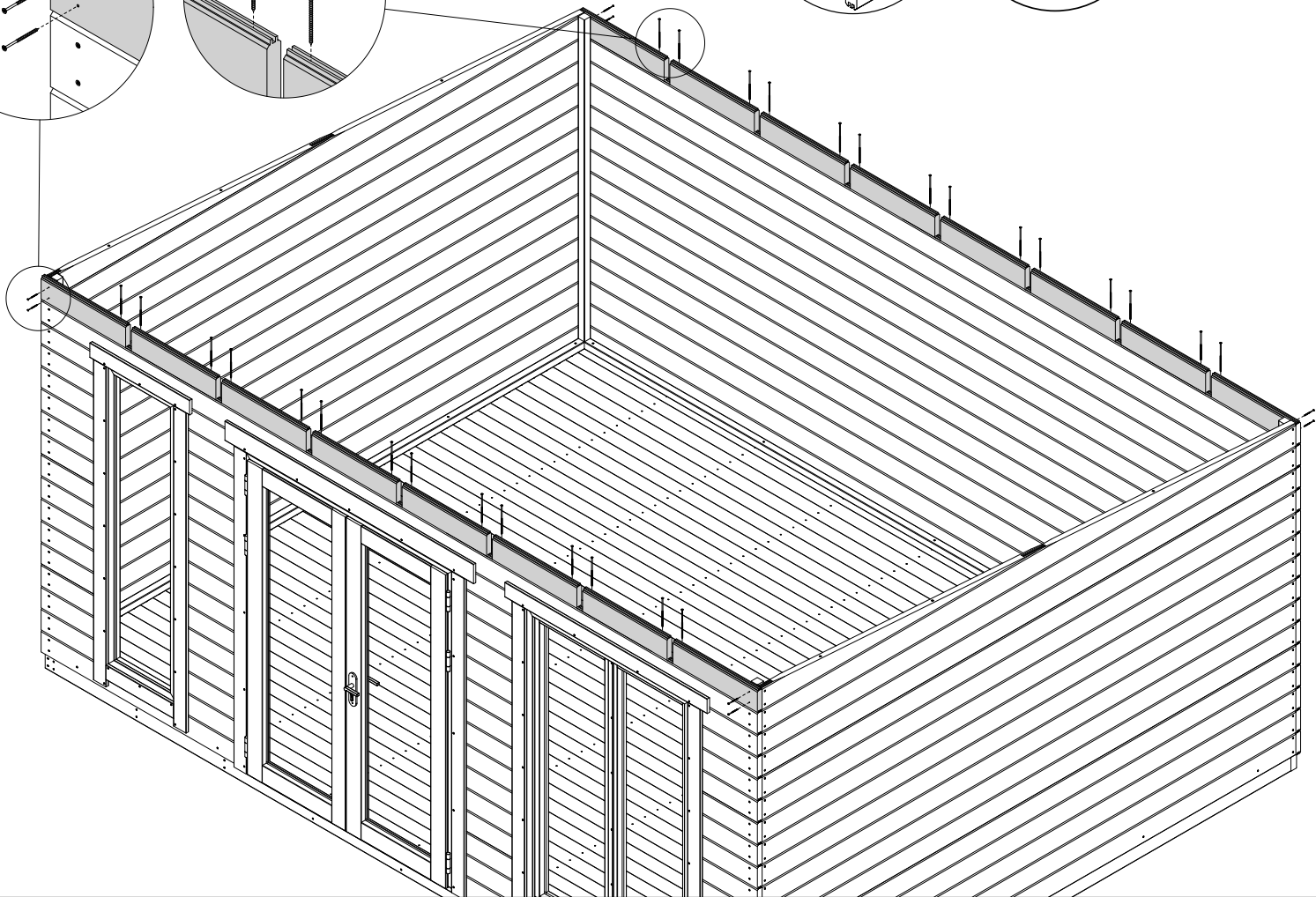
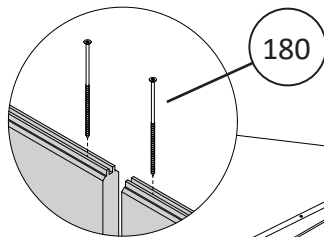
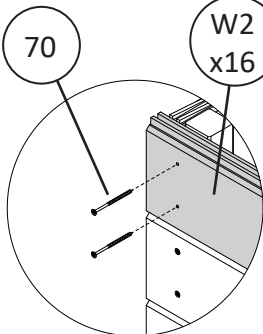
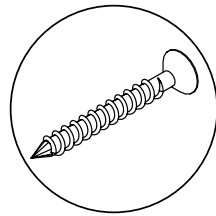
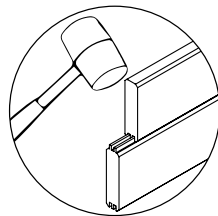
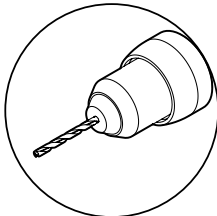
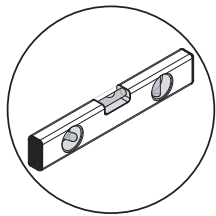
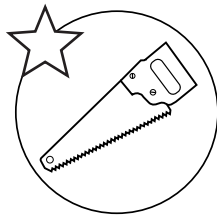

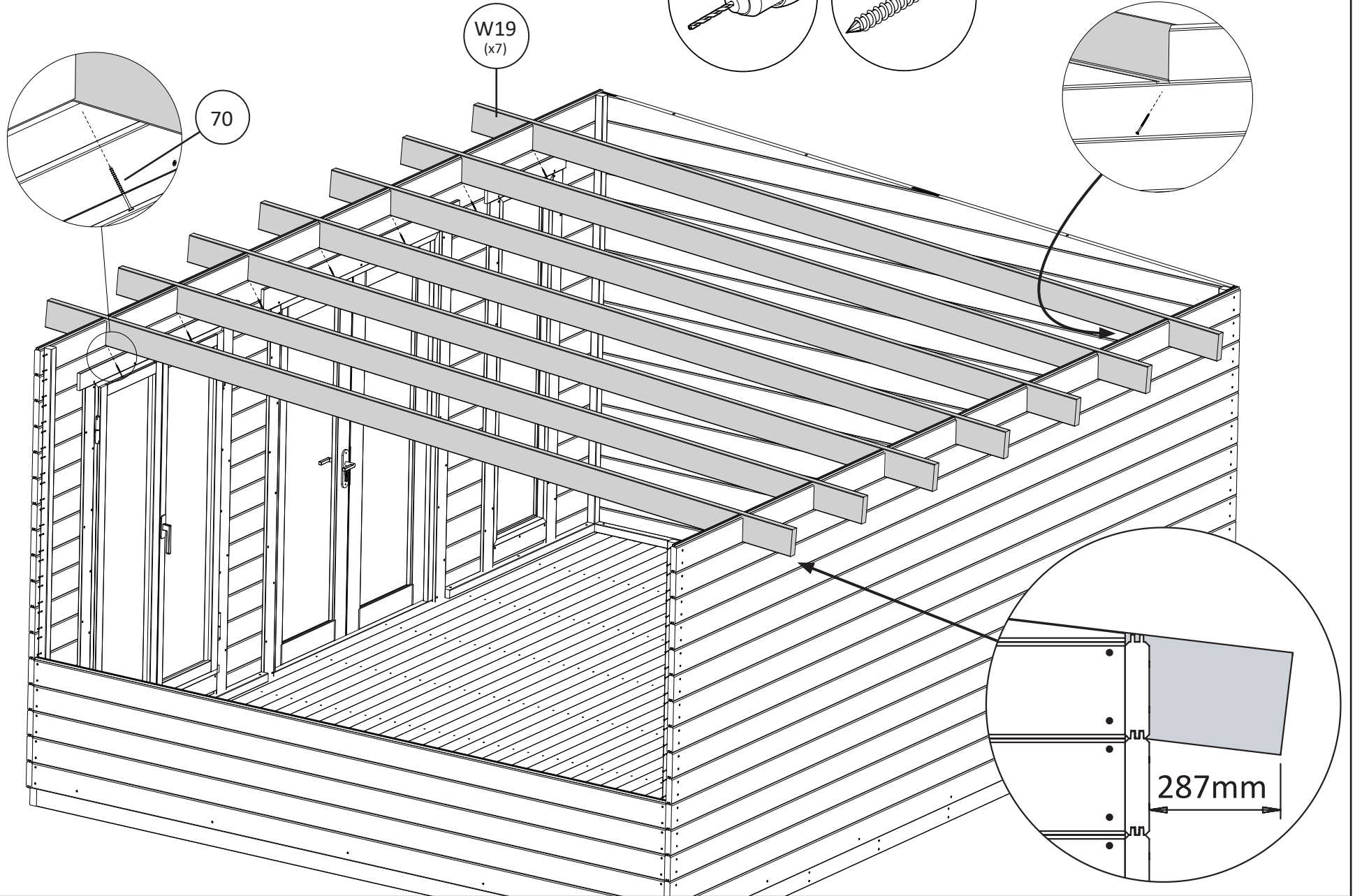
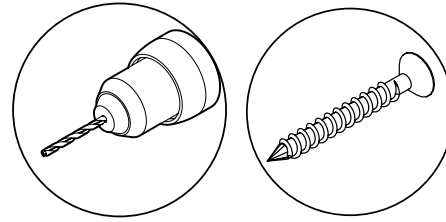

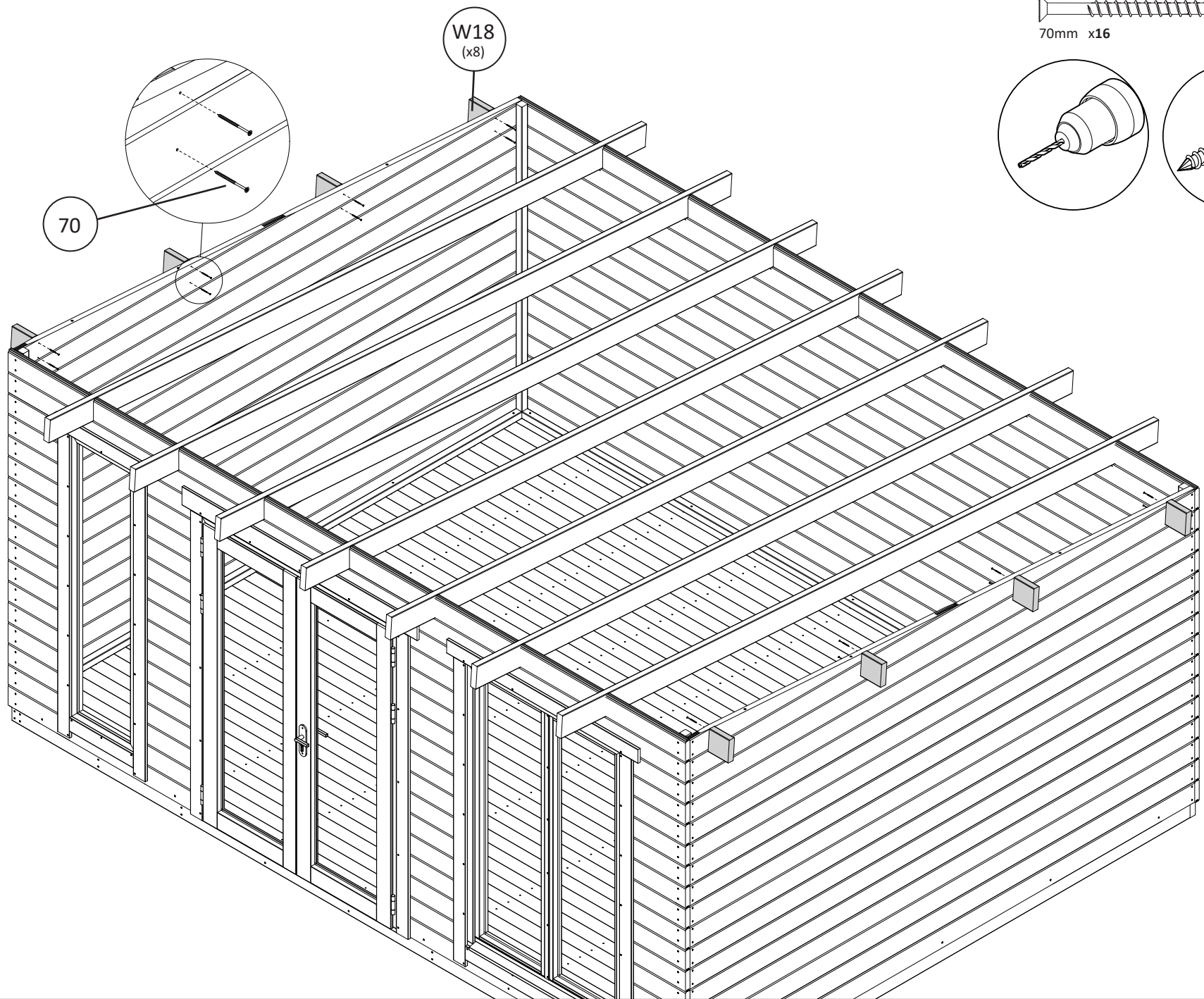

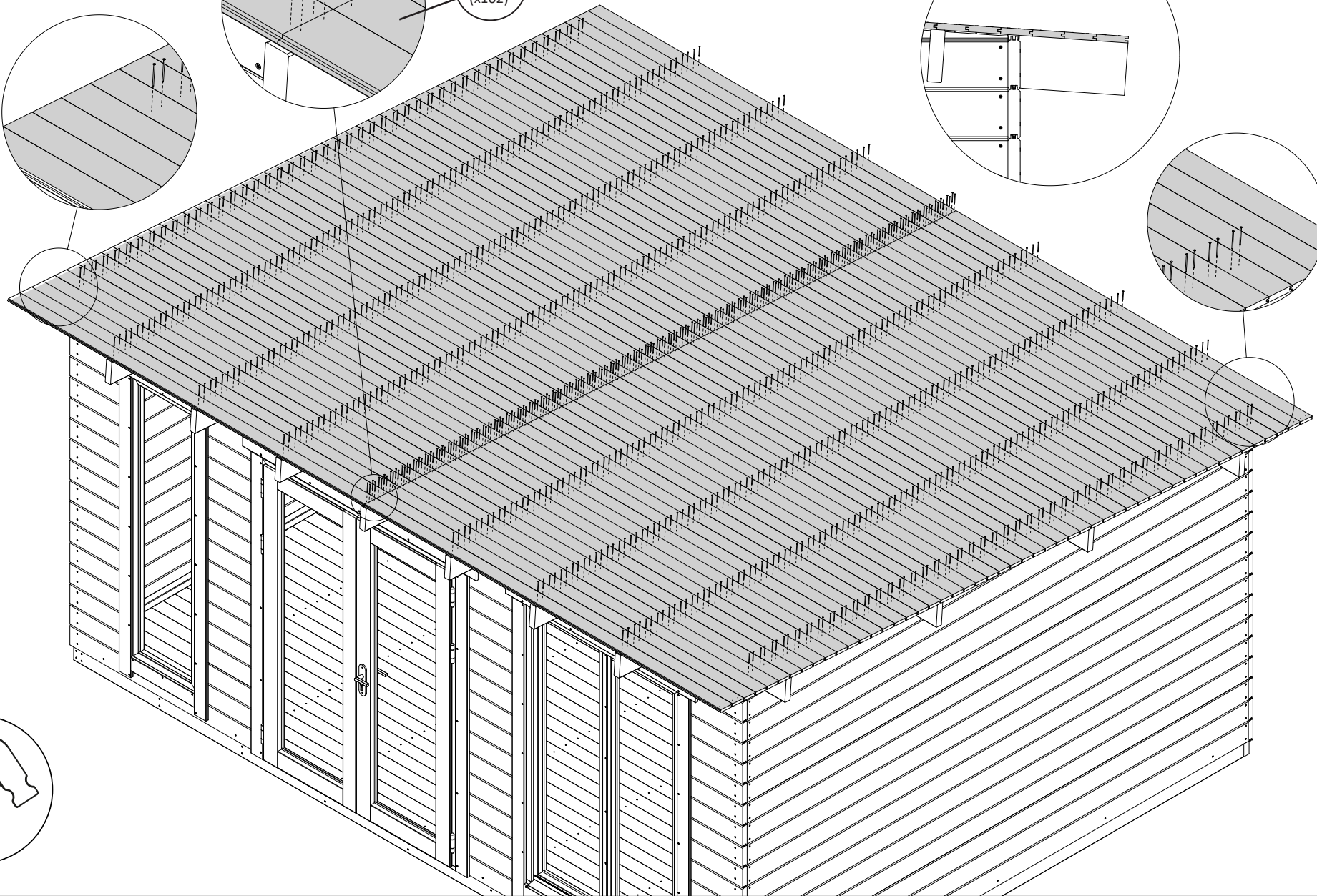
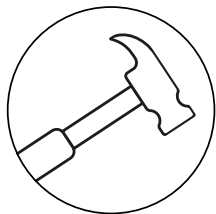
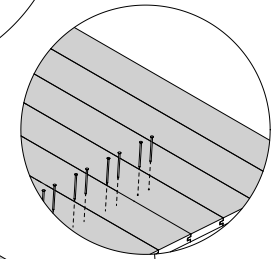
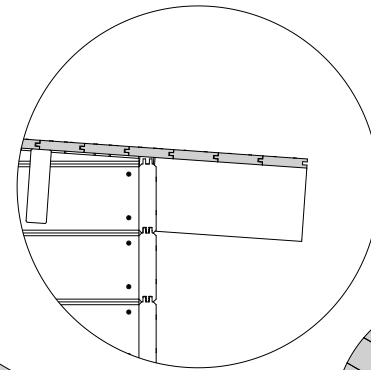
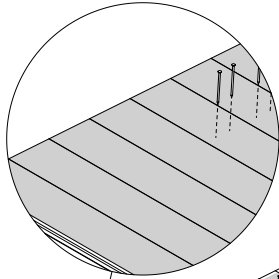
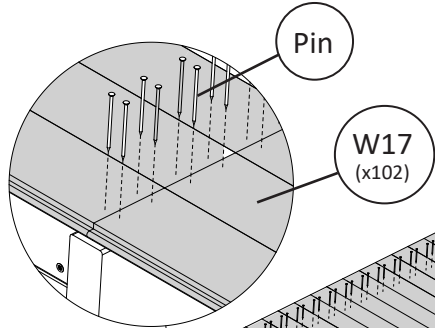
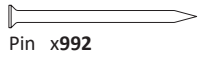

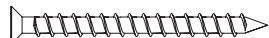
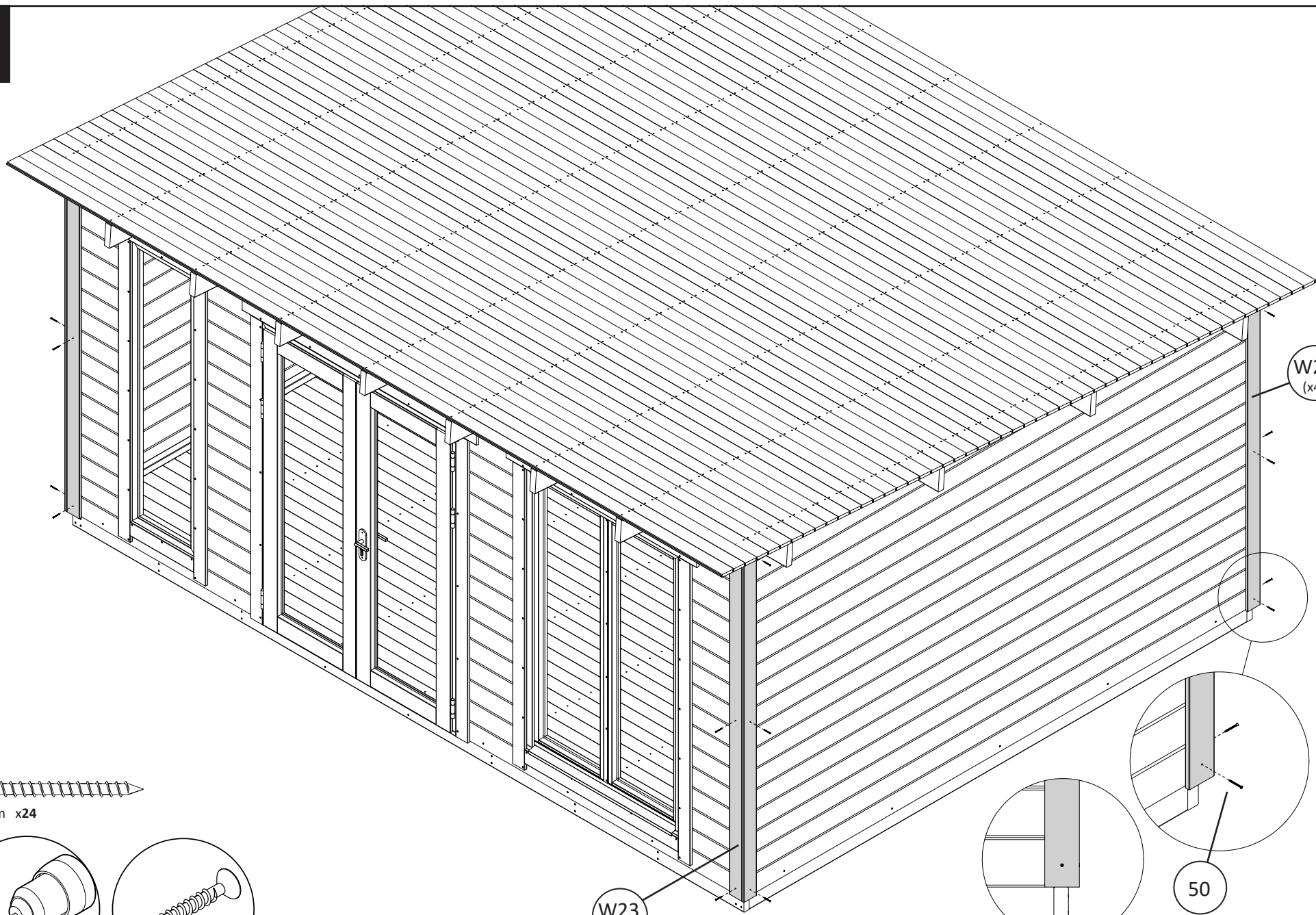

50mm x24

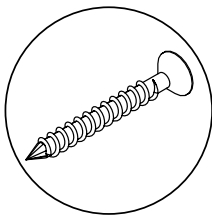
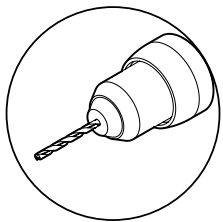

W23
(x4)

W22
(x4)

50

