

Art. Nr. 4434199

1/22

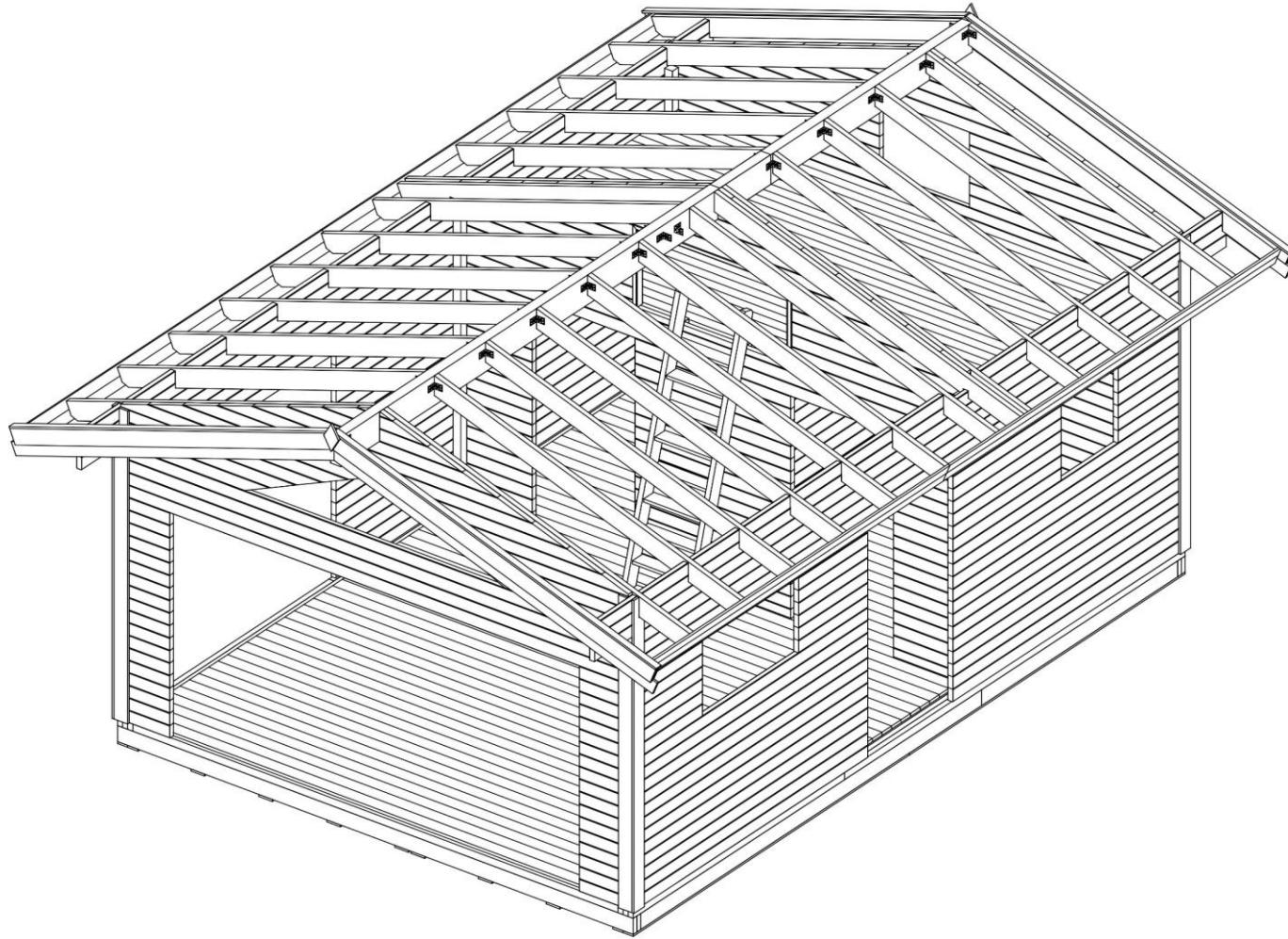

08.04.2024

Art. Nr. 4434199

Groundplan version 1

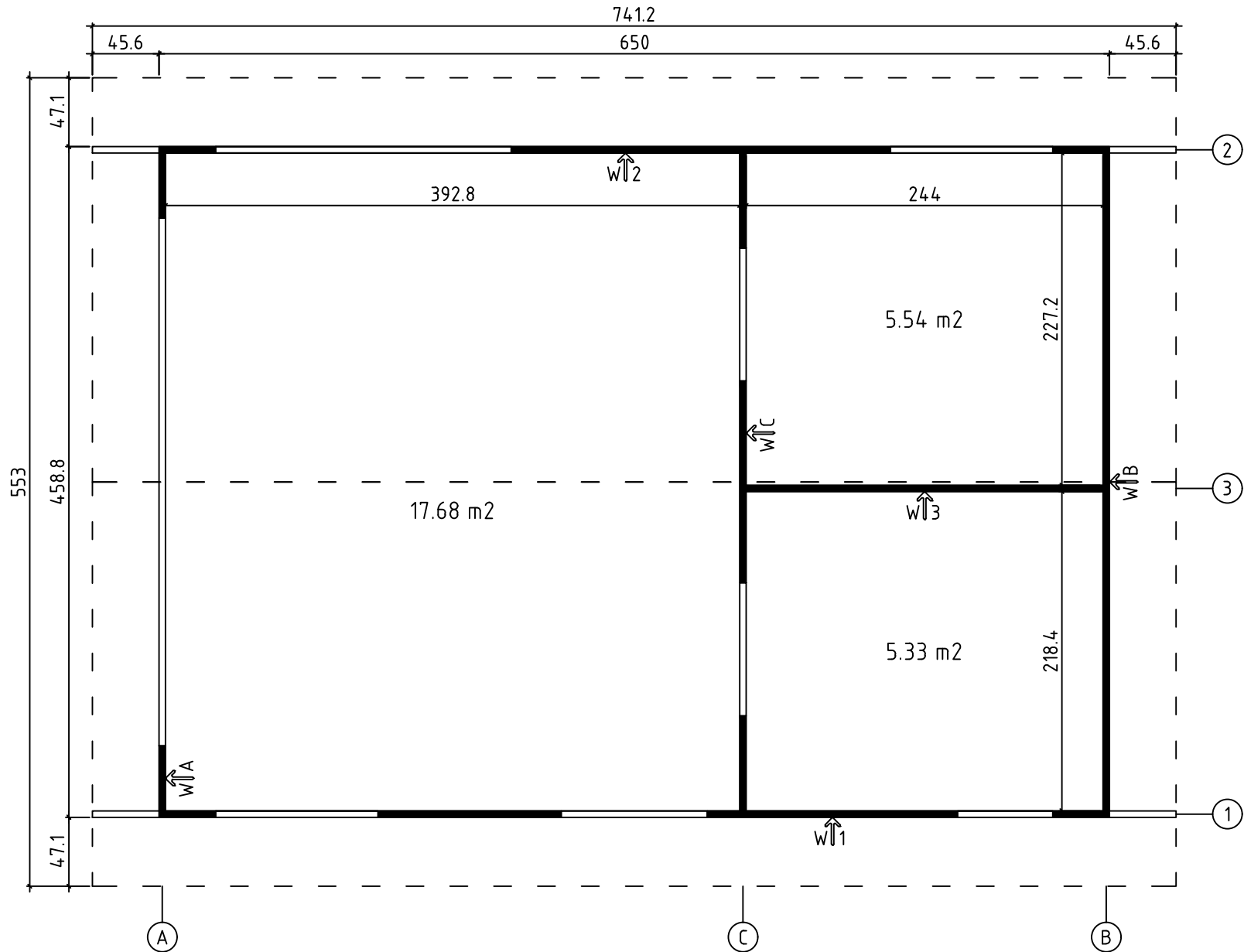

Art. Nr. 4434199

Groundplan version 2

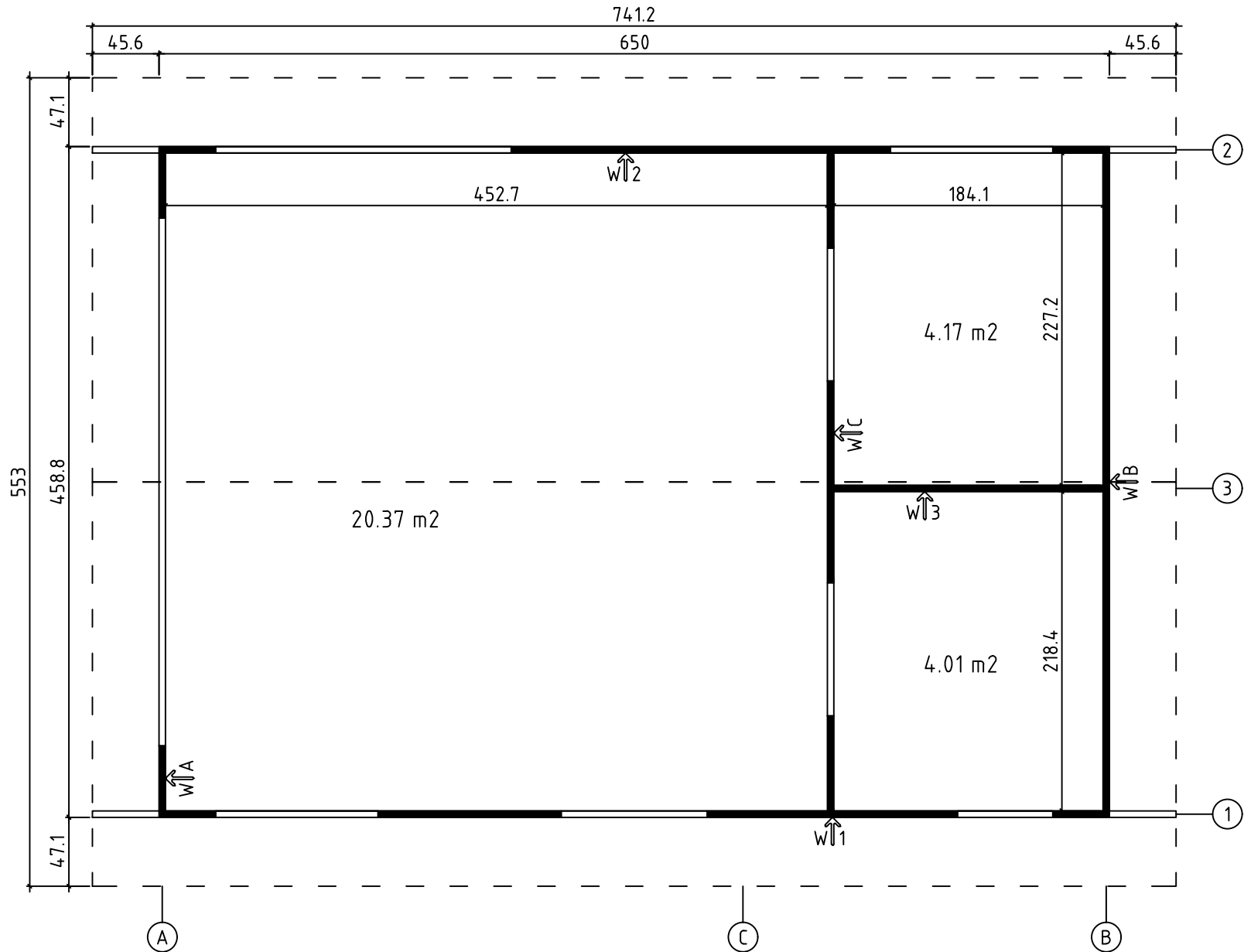

Art. Nr. 4434199

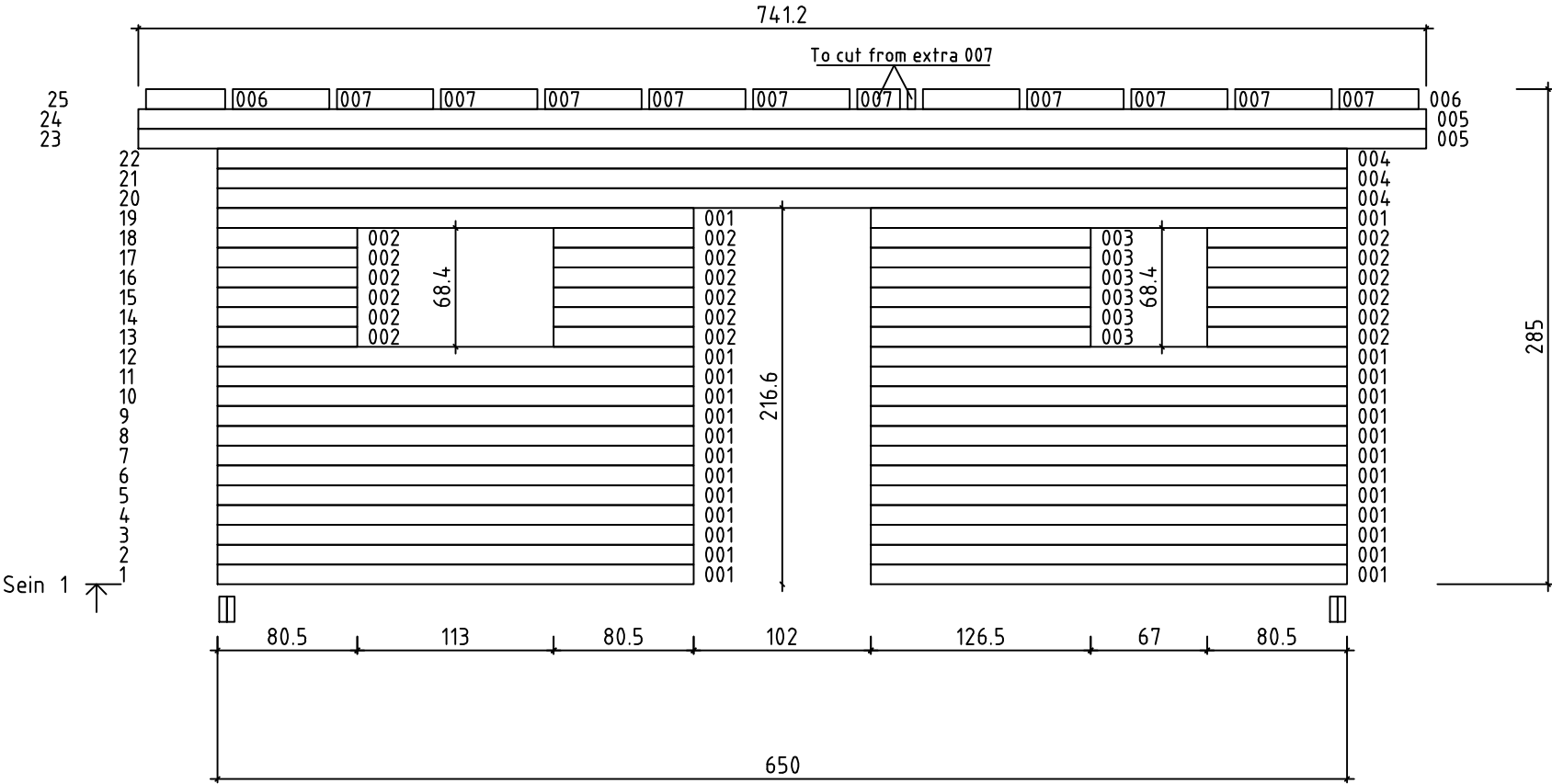

Art. Nr. 4434199

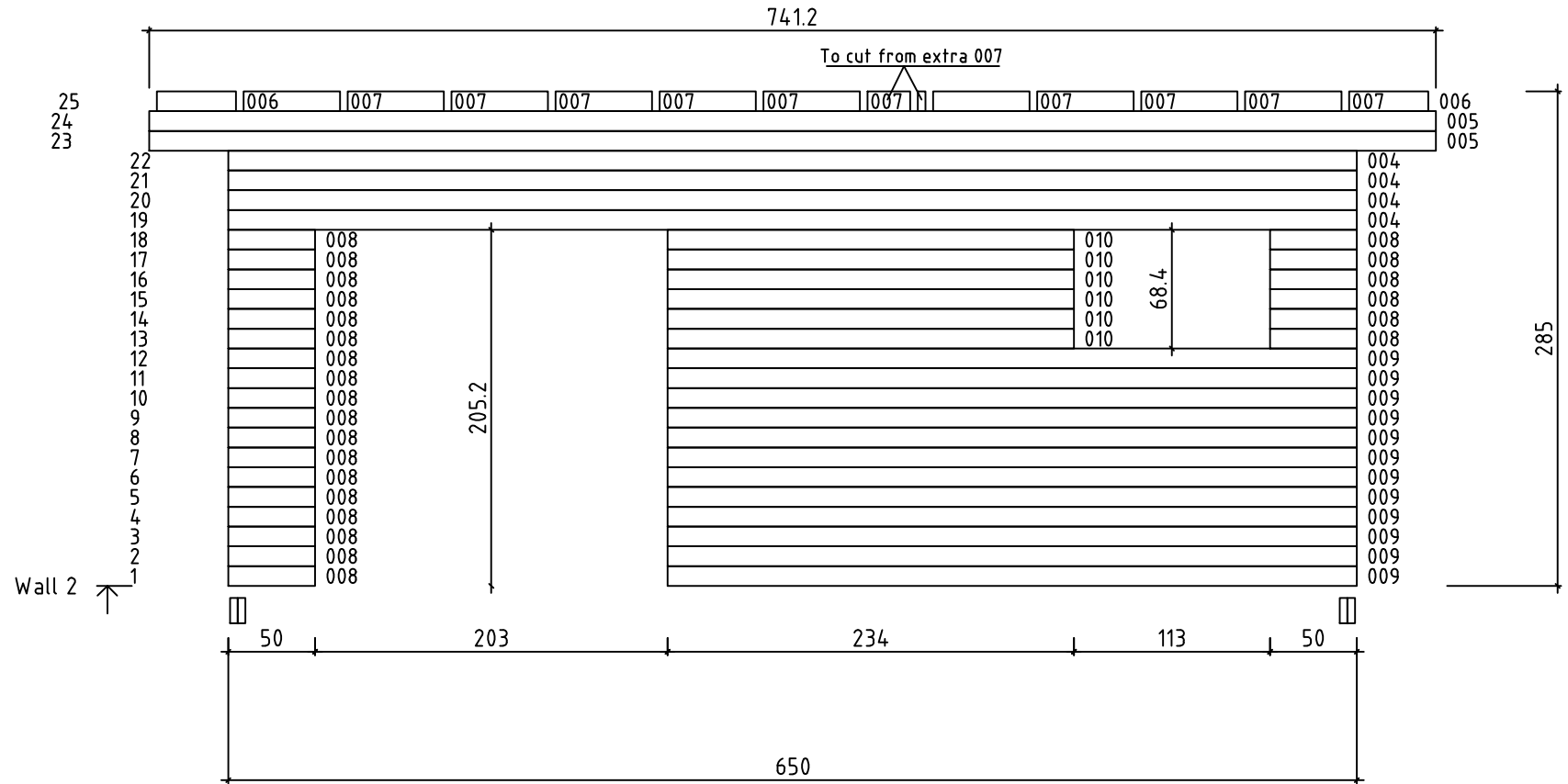

Art. Nr. 4434199

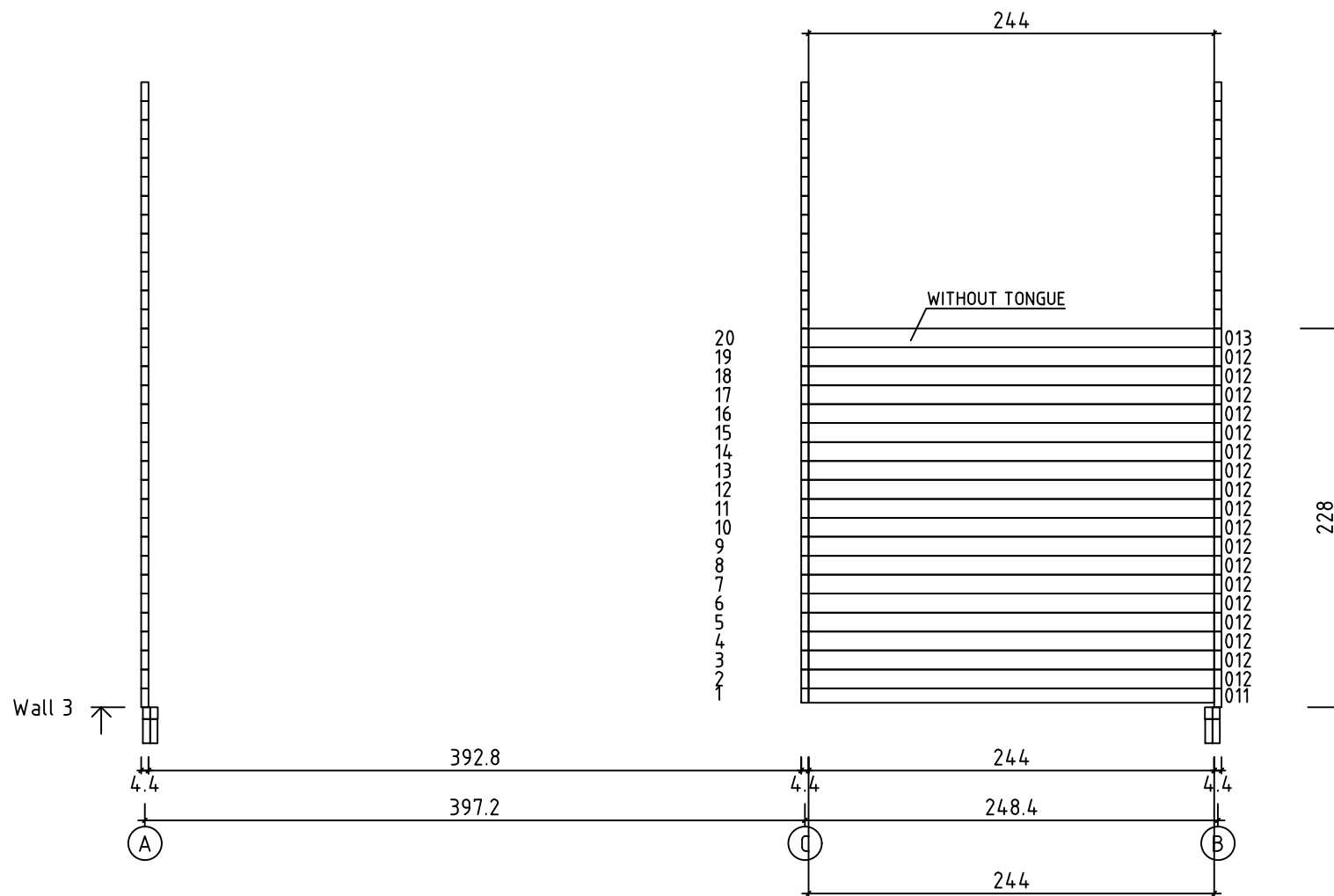

Art. Nr. 4434199

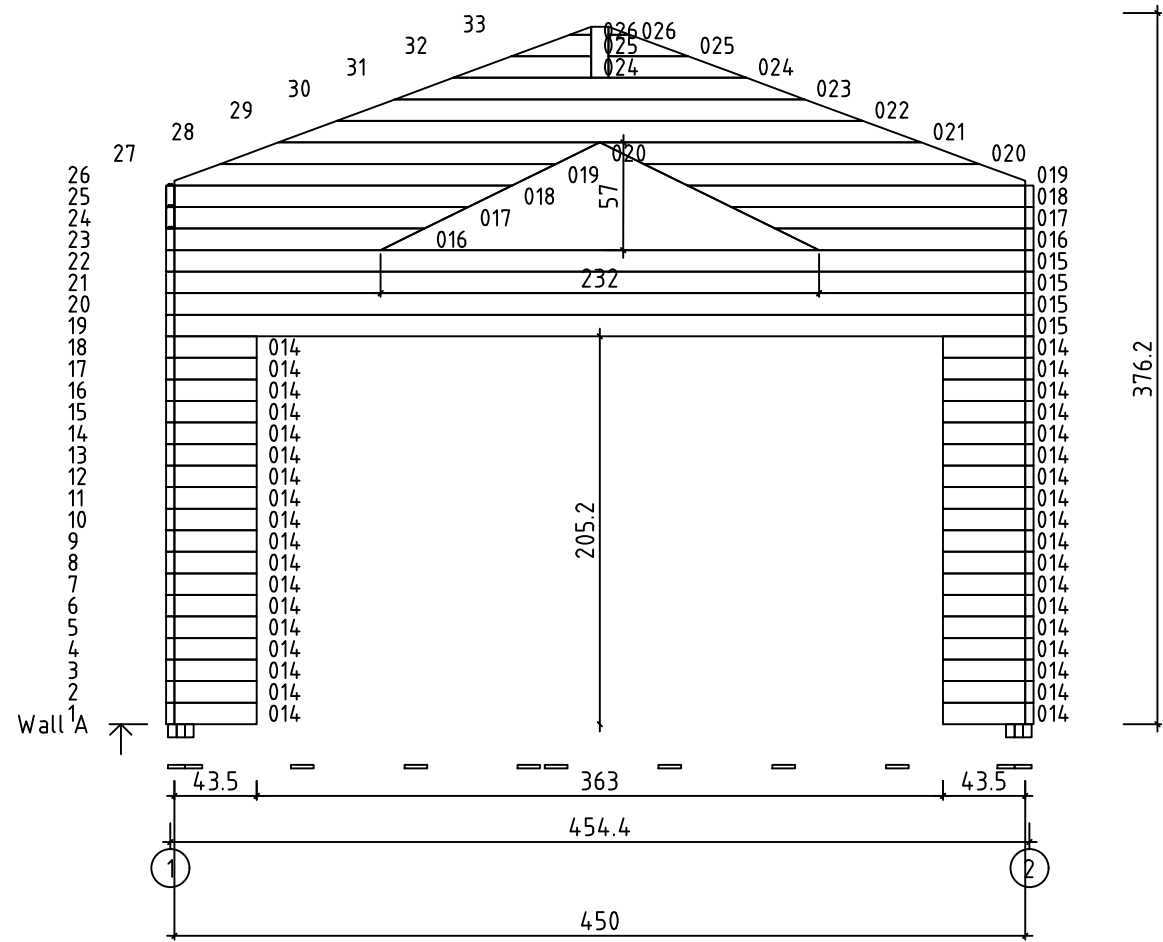

Art. Nr. 4434199

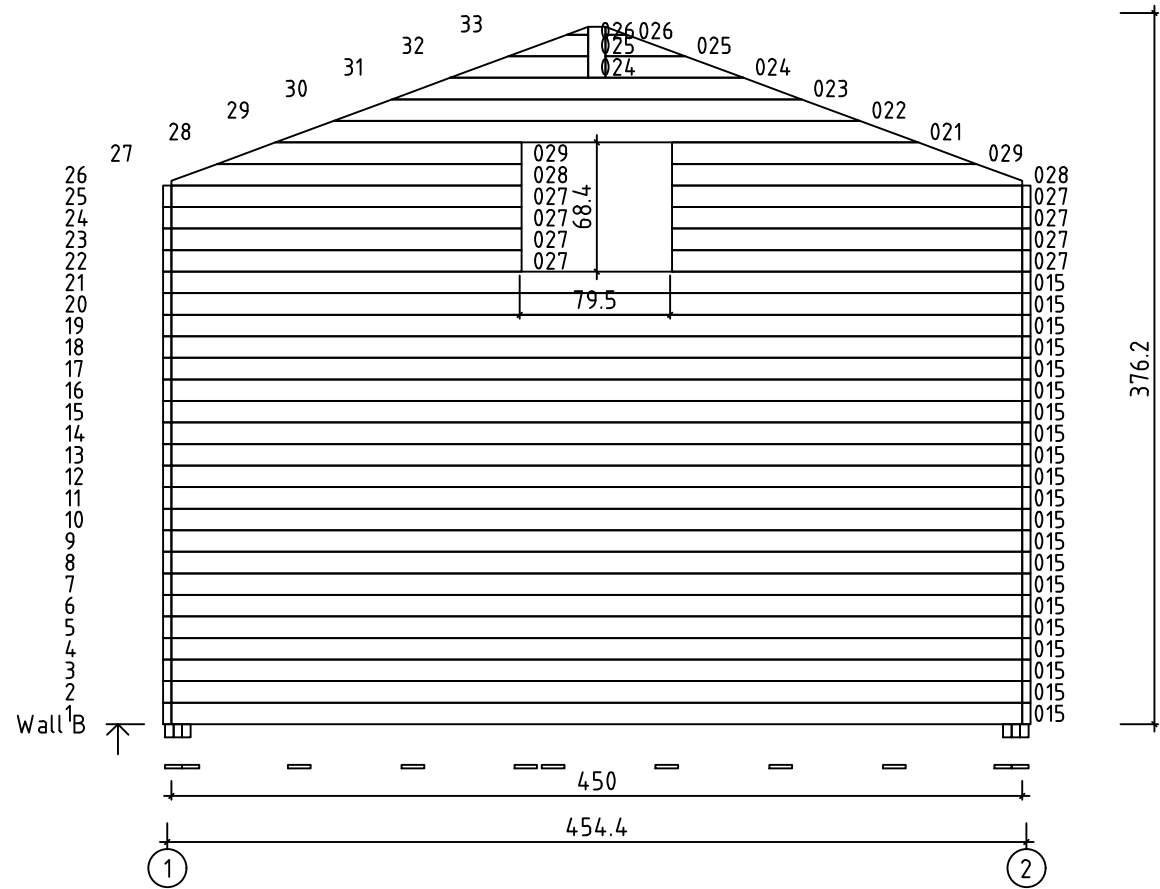

Art. Nr. 4434199

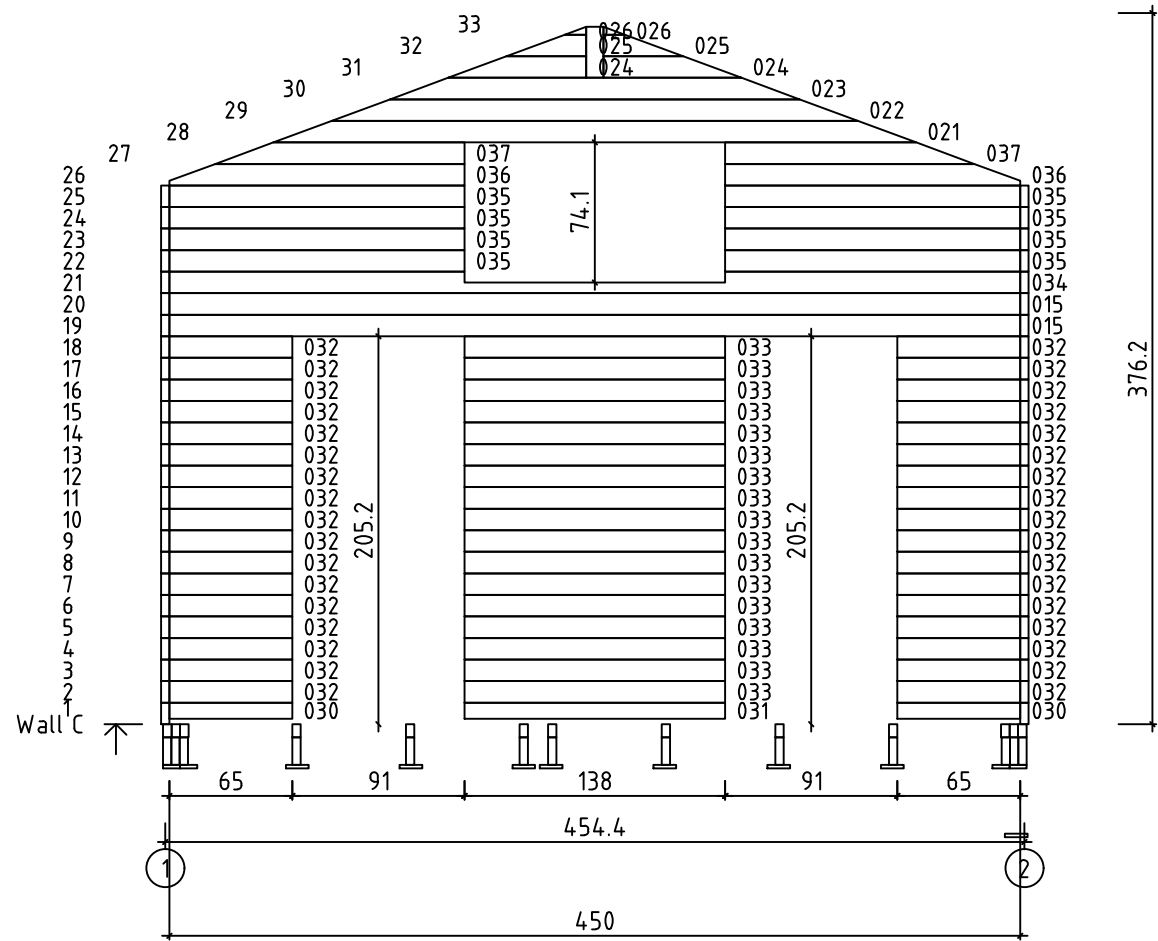

Art. Nr. 4434199

Impregnated foundation boards

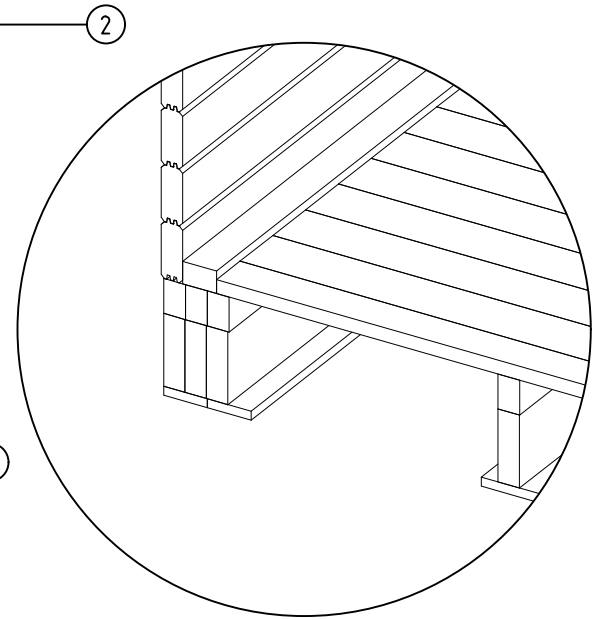
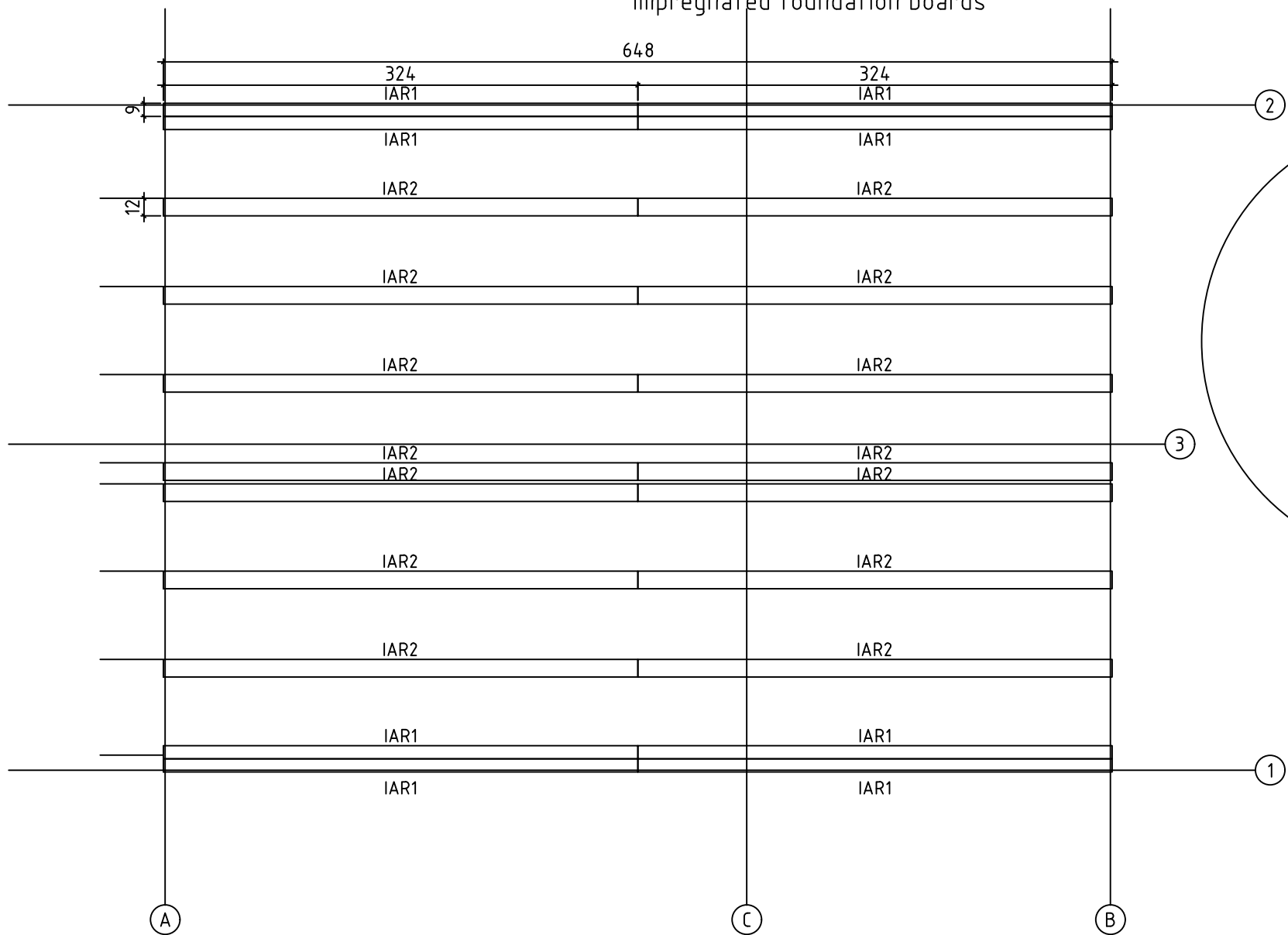

Art. Nr. 4434199

44x146 floor joists

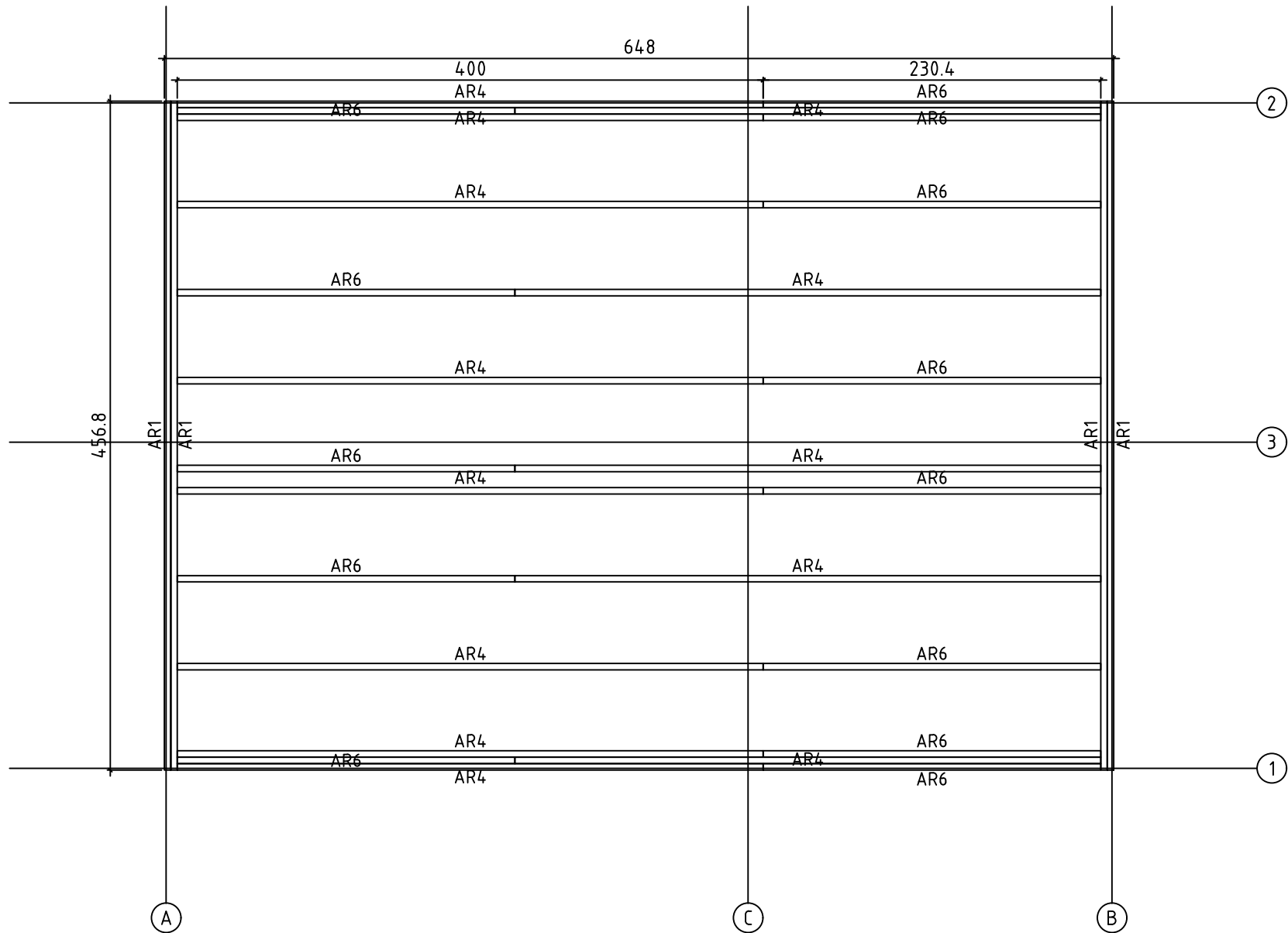

Art. Nr. 4434199

45x70 floor joists

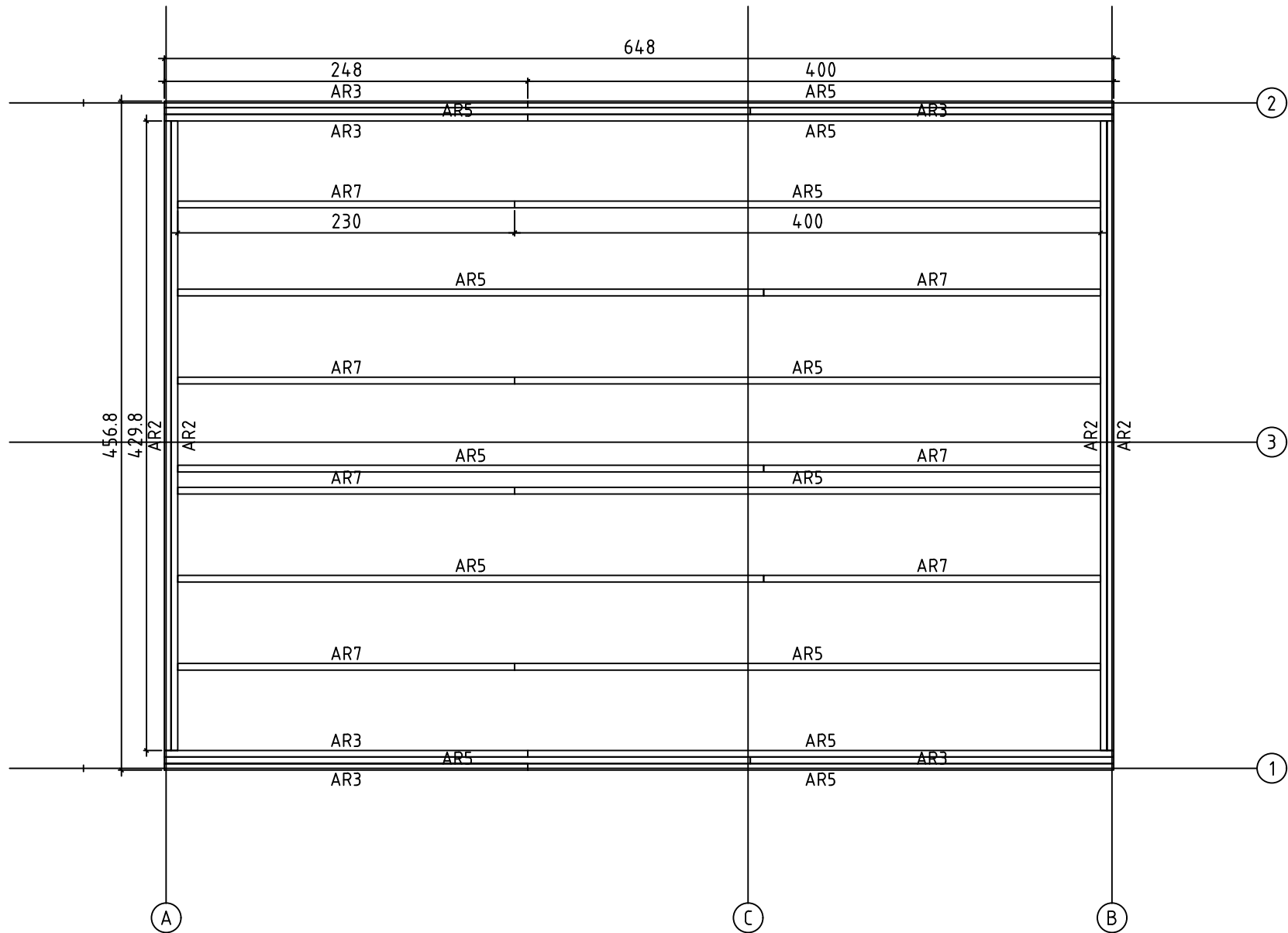

Art. Nr. 4434199

Rafters

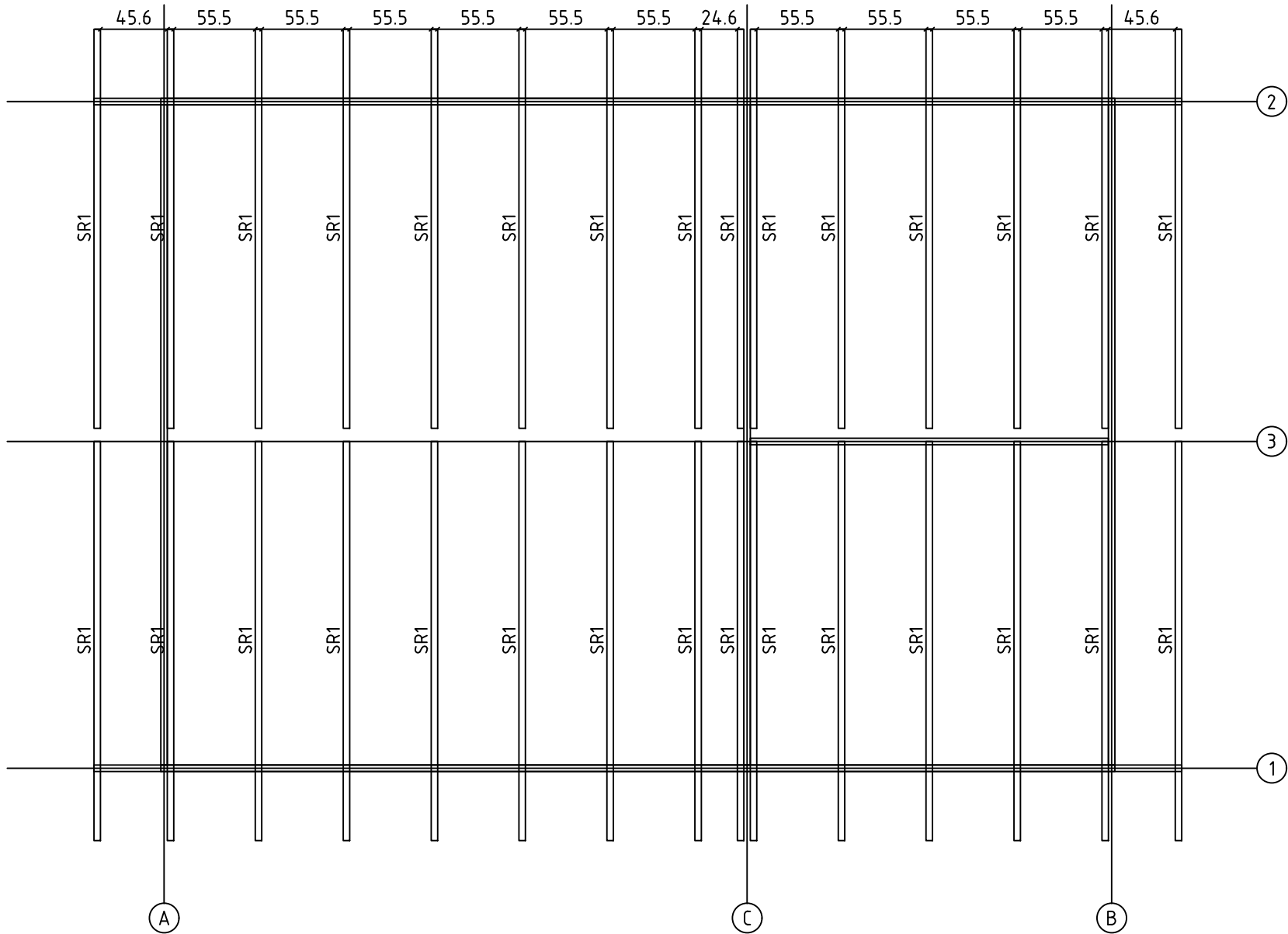

Art. Nr. 4434199

Loft beams

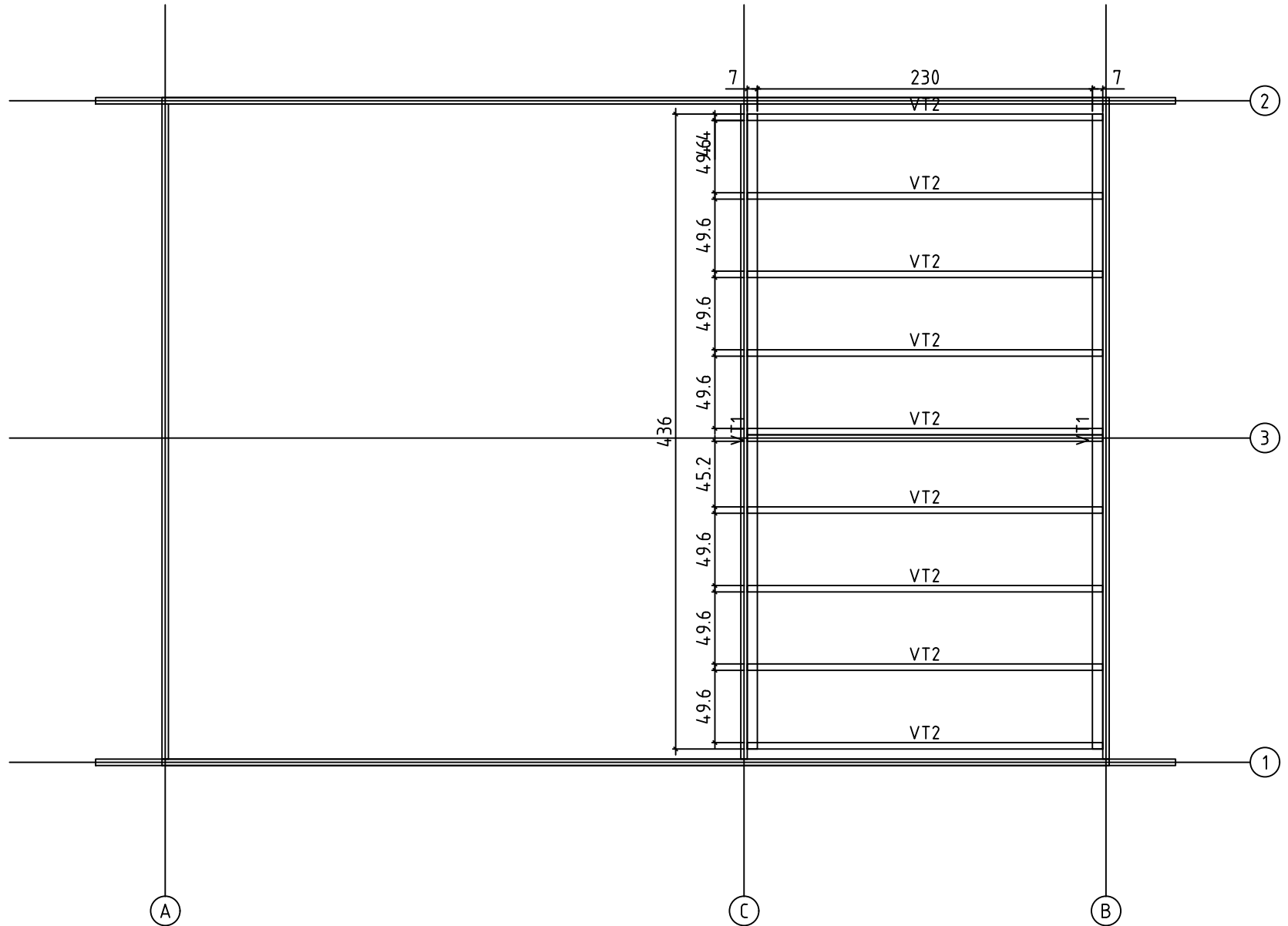

08.04.2024

14 / 22

Art. Nr. 4434199



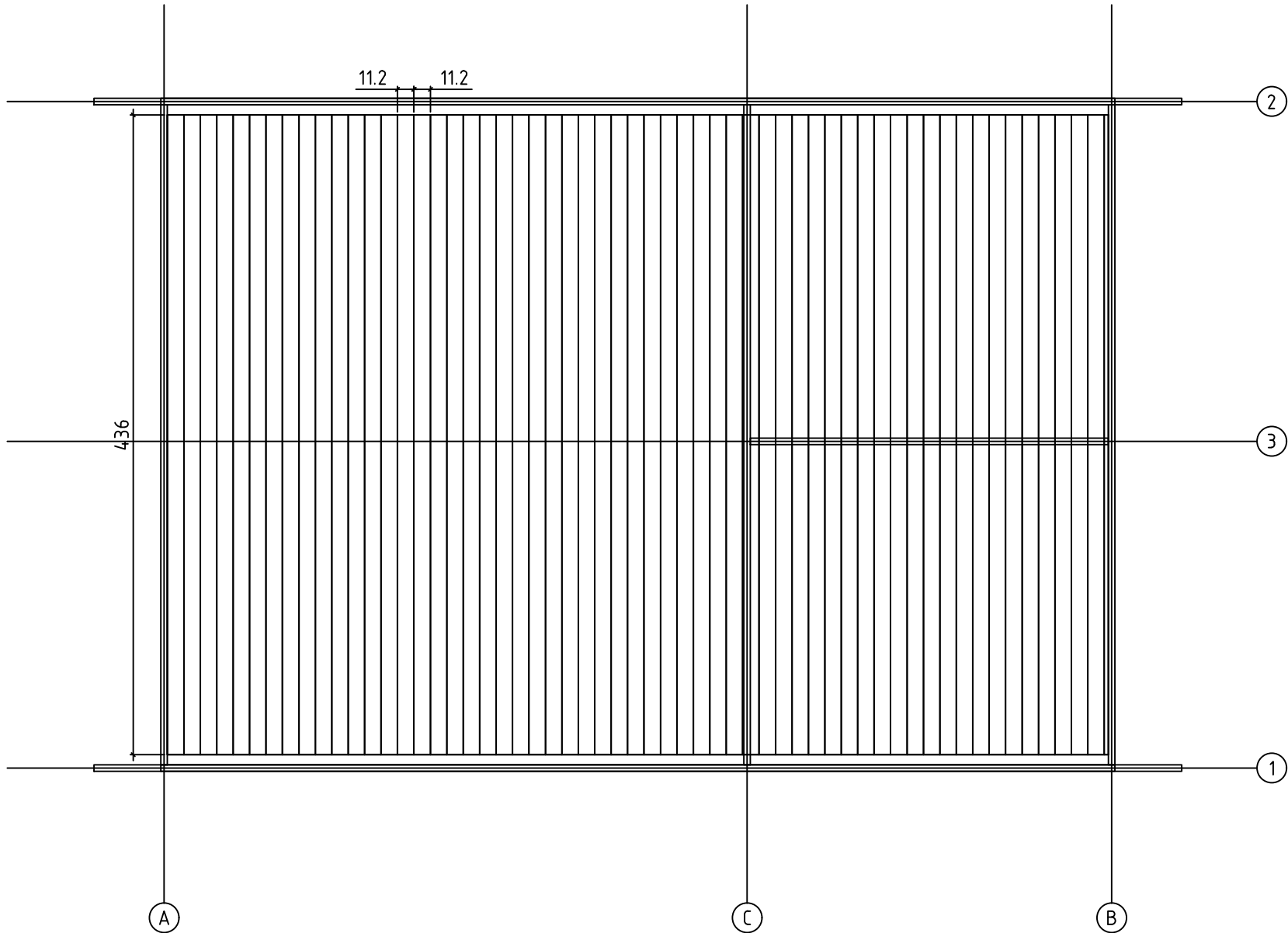





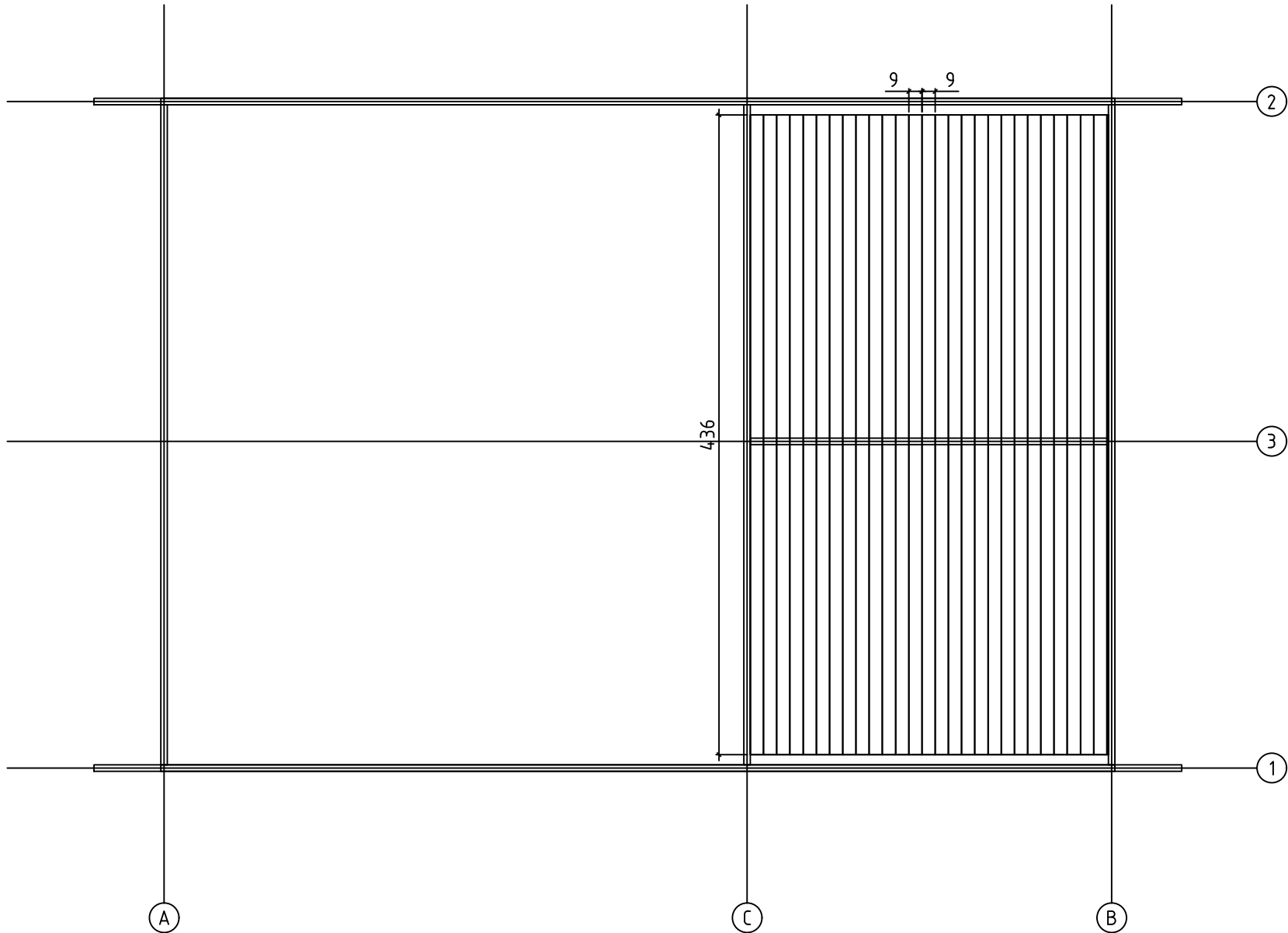

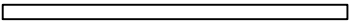
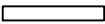
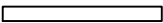
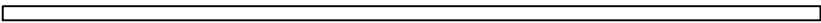
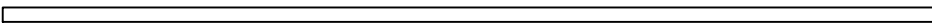



Floorboards

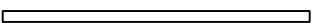

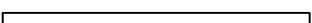

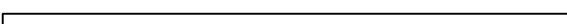
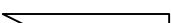
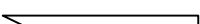
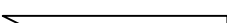
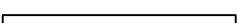

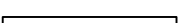



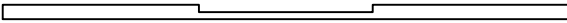
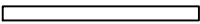
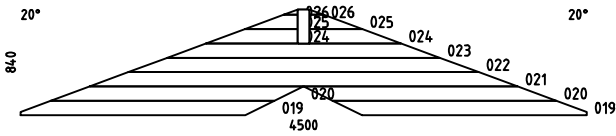
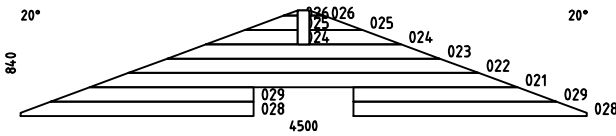
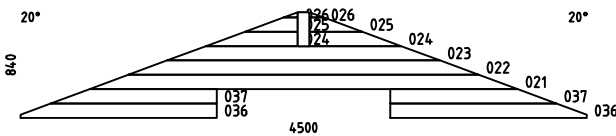
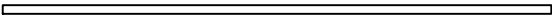
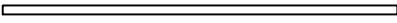



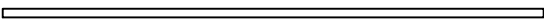
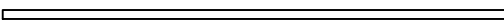
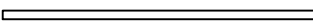
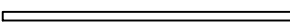

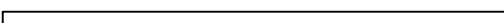

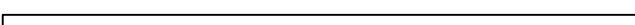







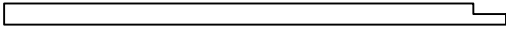
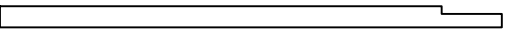

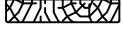
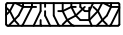
Art. Nr. 4434199

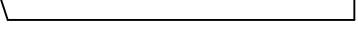
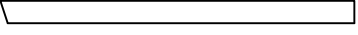
Loft floorboards



Pos	08.04.2024	PIECE LIST Art. Nr. 4434199	17/22	Arv	Profiil (mm)	Pikkus (mm)
001				26	44x114	2740
002				18	44x114	805
003				6	44x114	1265
004				7	44x114	6500
005				4	44x114	7412
006				4	44x114	456
007				20	44x114	555
008				24	44x114	500
009				12	44x114	3970
010				6	44x114	2340
011				1	44x86	2440
012				18	44x114	2440
013				1	44x114	2440
014				36	44x114	435
015				27	44x114	4500
016				2	44x114	1322
017				2	44x114	1554
018				2	44x114	1786
027				8	44x114	1853
030				2	44x86	650
031				1	44x86	1380
032				34	44x114	650
033				17	44x114	1380

Pos	08.04.2024	PIECE LIST Art. Nr. 4434199	18/22	Q.	P (mm)	L (mm)
034				1	44x114	4500
035				8	44x114	1560
WA-1				1		
WB-1				1		
WC-1				1		
PT1		FLOOR FILLET		4	70x70	4360
PT2		FLOOR FILLET		6	70x70	3136
VT1		MEZZANINE FLOOR JOISTS		2	70x45	4360
VT2		MEZZANINE FLOOR JOISTS		9	44x146	2440
IAR2		FOUNDATION		14	120x18	3240
IAR1		FOUNDATION		8	90x18	3240
AR2		FOUNDATION		4	45x70	4298
AR5		FOUNDATION		13	45x70	4000
AR3		FOUNDATION		6	45x70	2480
AR7		FOUNDATION		7	45x70	2300
AR1		FOUNDATION		4	44x146	4568
AR4		FOUNDATION		13	44x146	4000
AR6		FOUNDATION		13	44x146	2304
SR1		RAFTER		30	44x170	2900
A-PR1		ROOF BEAM		1	90x270	5049

Pos	08.04.2024	PIECE LIST Art. Nr. 4434199	19/22	Q.	P (mm)	L (mm)
A-PR2		ROOF BEAM 		1	90x270	2962
HLL-1	FLOOR BOARDS			58	112x28	4360
FB-1	FLOOR BOARDS			28	90x18.5	4360
RB-1	ROOF BOARDS			66	90x18.5	5093
RB-2	ROOF BOARDS			66	90x18.5	2319
RFF	ROOFING FELT FILLET			4	18x58	3050
RS1	RAILING STRIP			4	18x120	2850
RS2	RAILING STRIP			4	18x120	2850
P1	POST			2	70x70	2061
P2	POST			8	70x70	2700
TB1	EAVES BOARD			4	18x90	3517
TB2	EAVES BOARD			4	18x90	3895
UT-1	U-PROFILE			2	35x70	740
UT-2	U-PROFILE			1	35x70	1400
GL1	GABLE MOULDING			8	18x120	3050
GL2	GABLE MOULDING			4	18x140	3050
	LADDER			1		
HS8	SCREW			400	3.5x35	
HS9	SCREW			250	3.5x50	
HSx	SCREW			500	3.9x70	
HS13	SCREW			40	4x60	
HS18	SCREW			60	5x120	
HS16	SCREW			1000	5x90	

Art. Nr. 4434199

U.3TV.b 900x1990

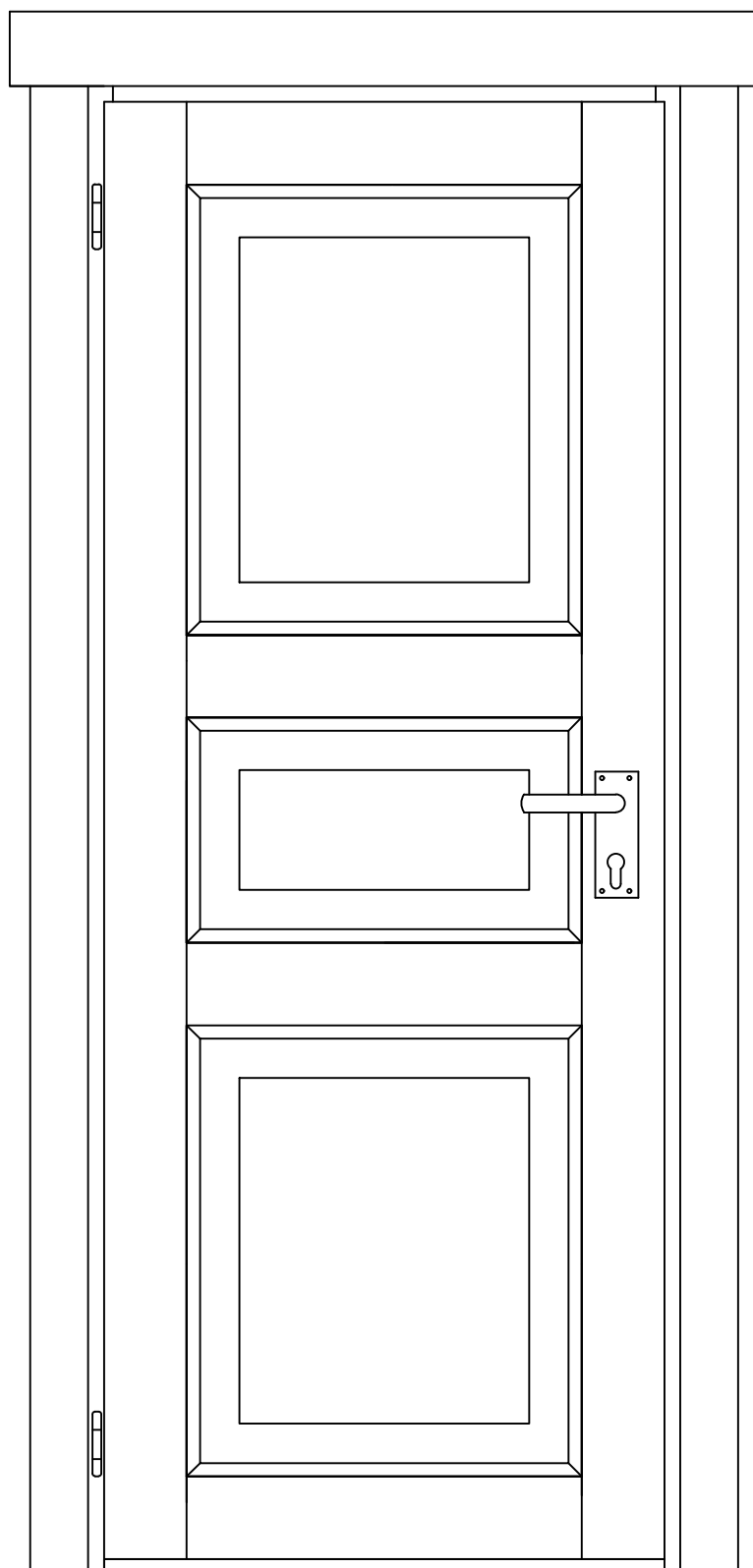

Art. Nr. 4434199

U.3TP.b 900x1990

