

Art. Nr. 4432399

1/22

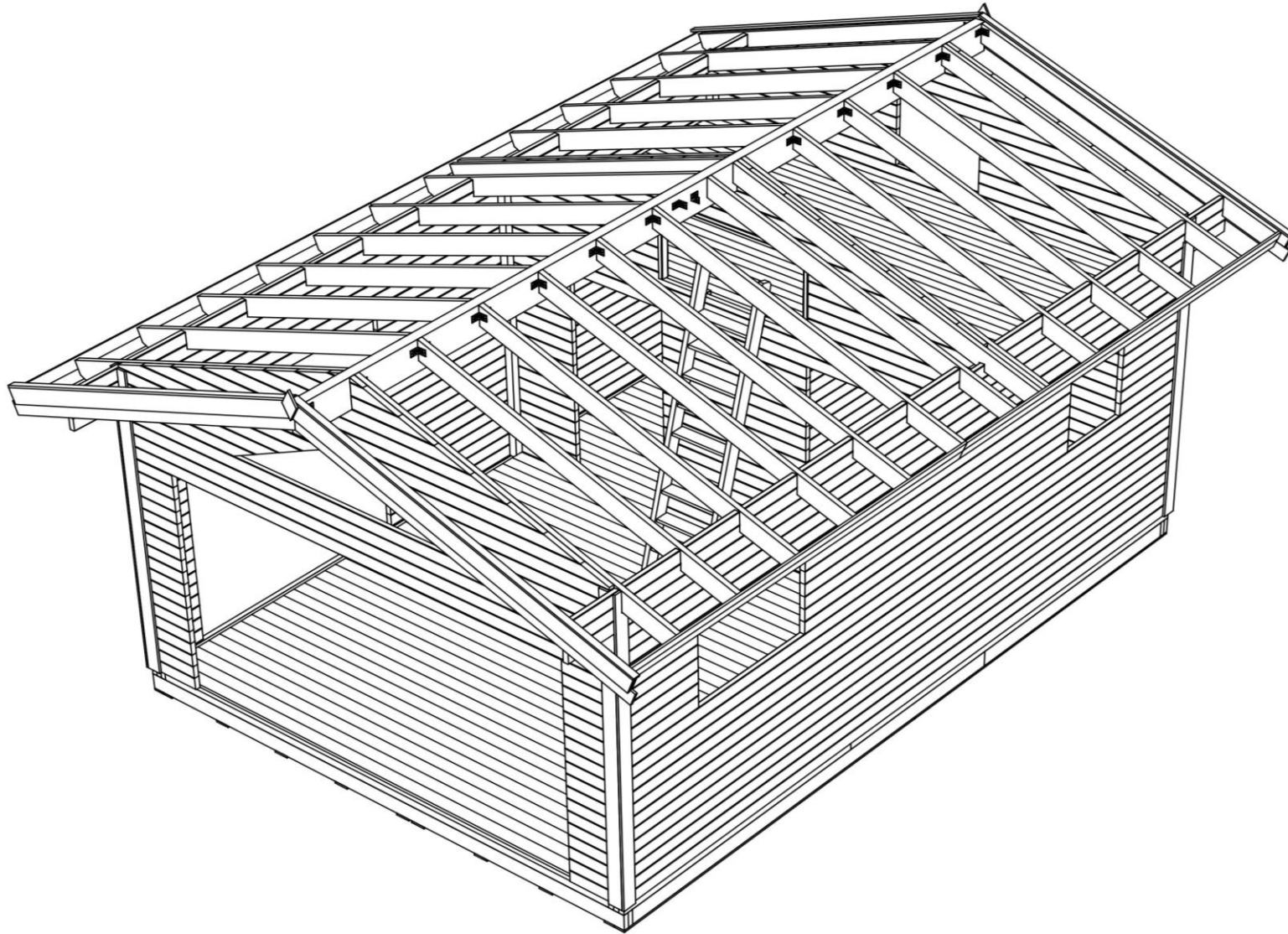

03.05.2024

Art. Nr. 4432399

Groundplan version 1

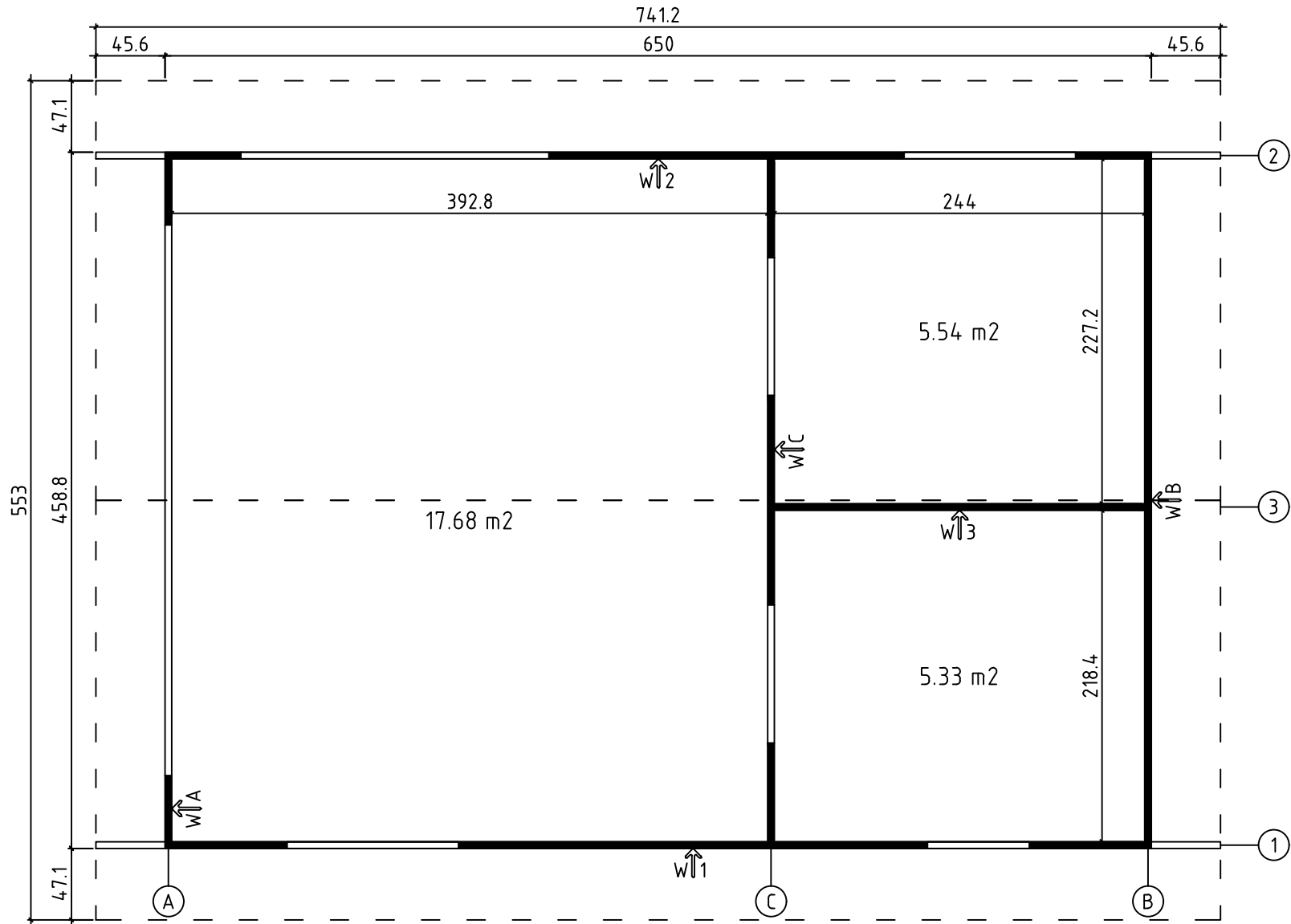

Art. Nr. 4432399

Groundplan version 2

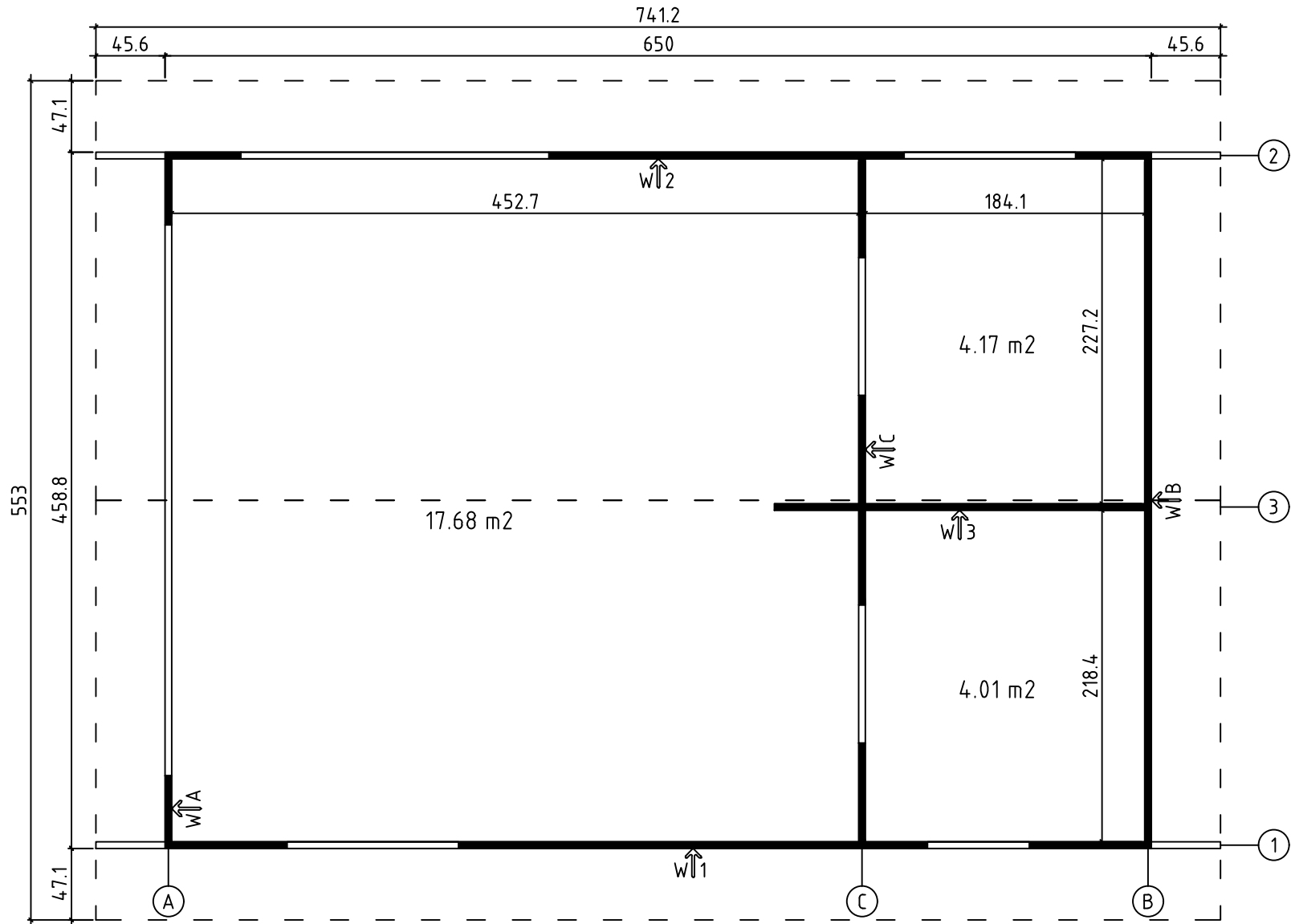

Art. Nr. 4432399

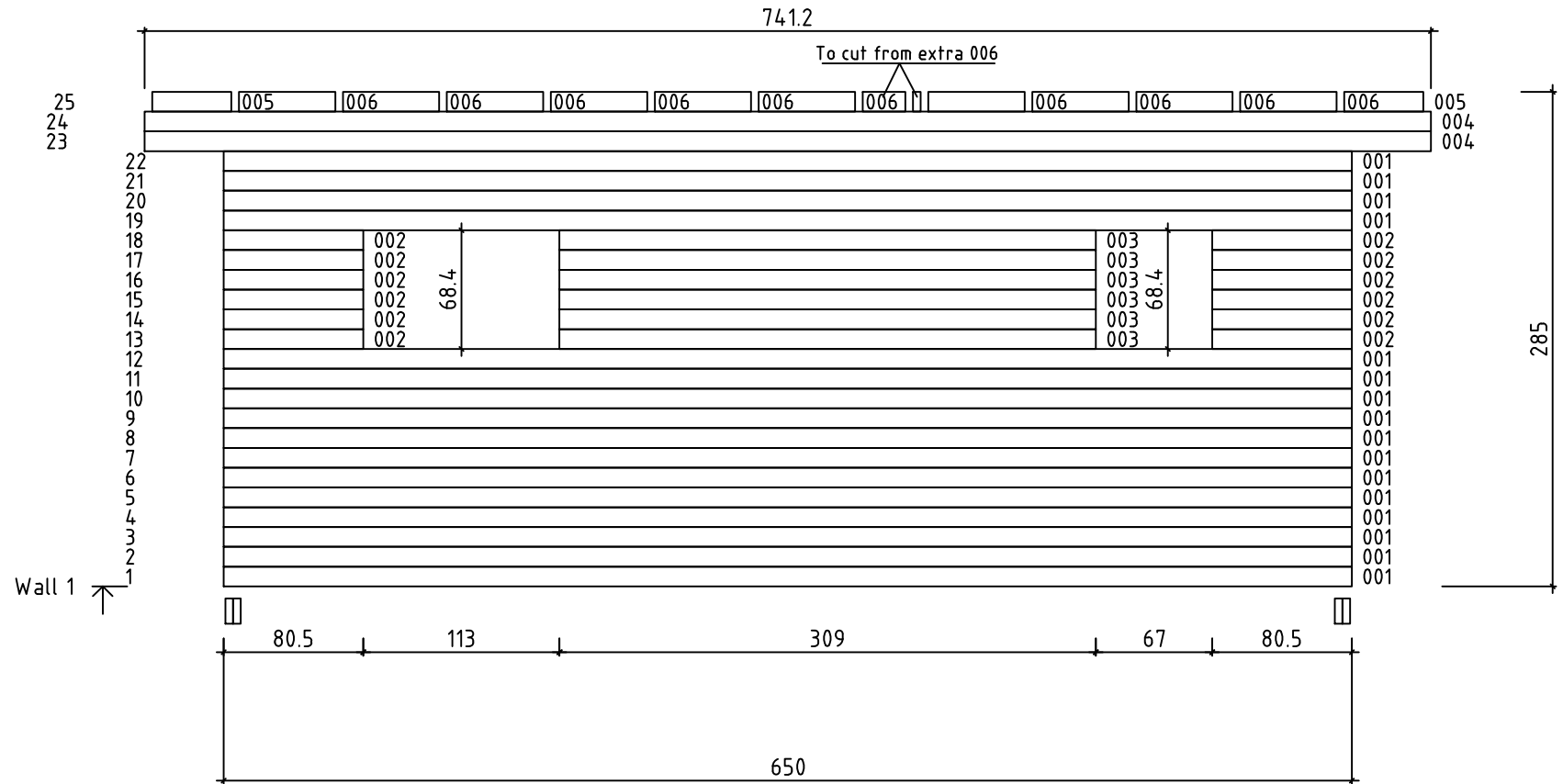

Art. Nr. 4432399

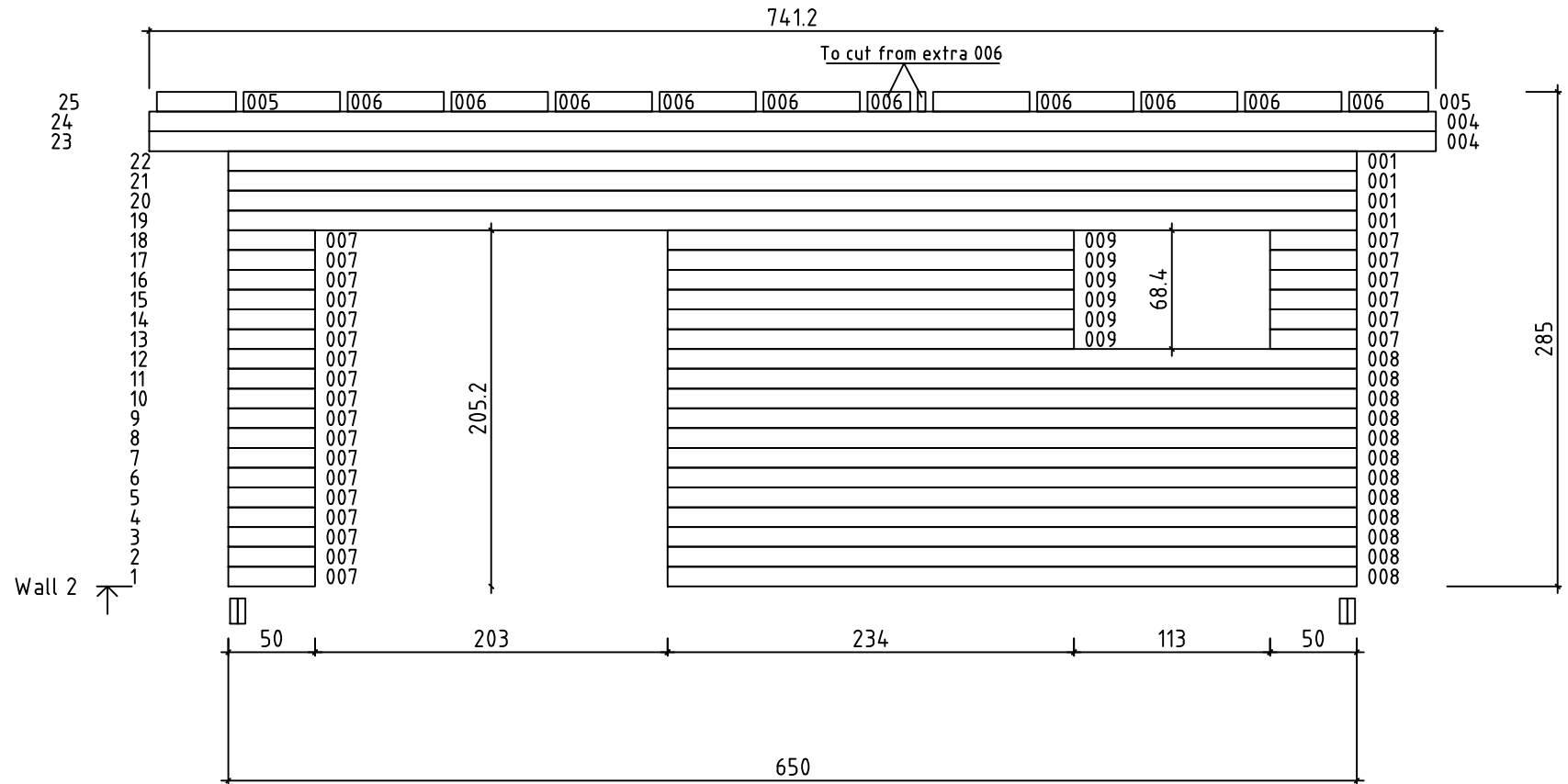

Art. Nr. 4432399

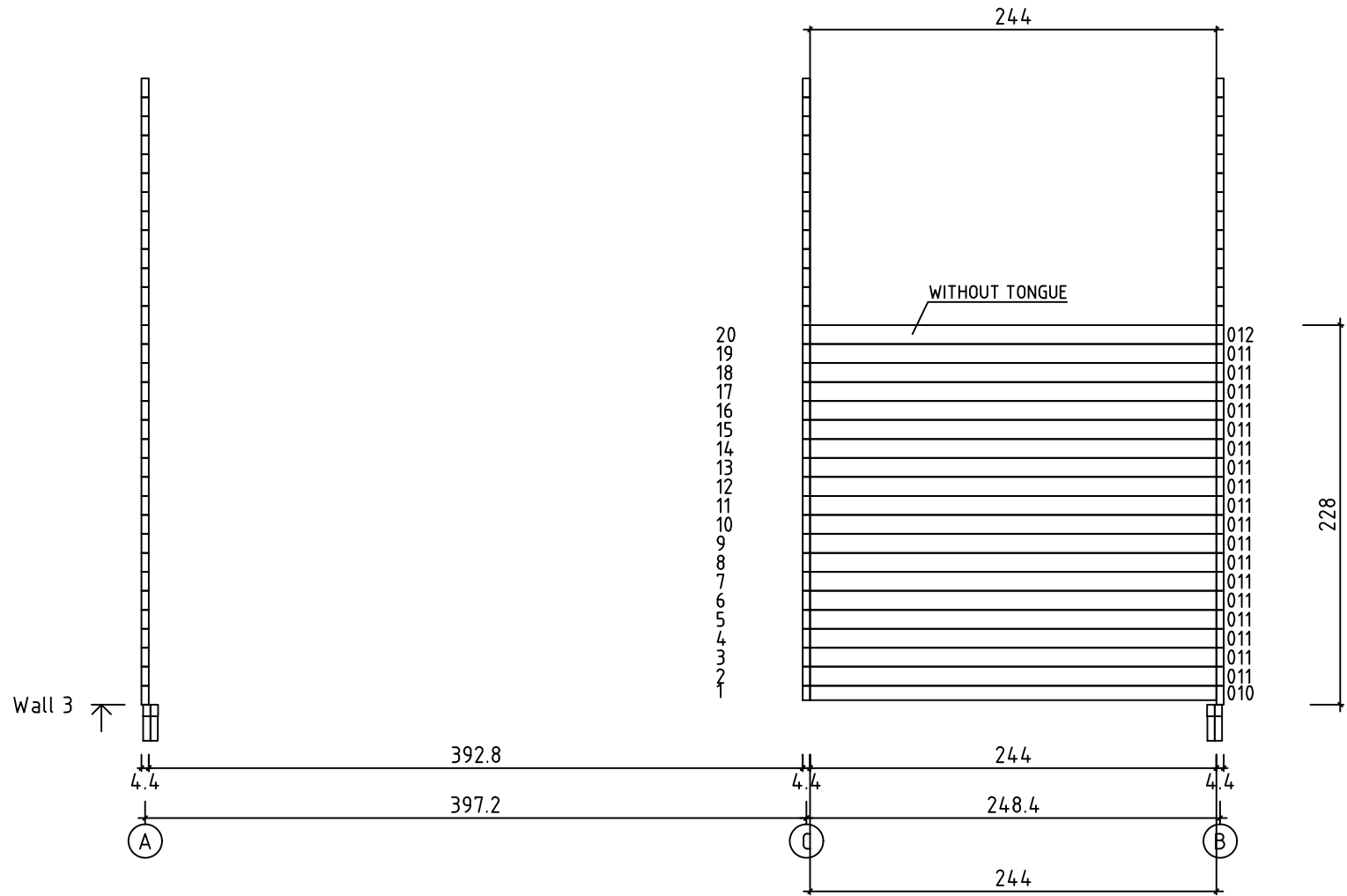

Art. Nr. 4432399

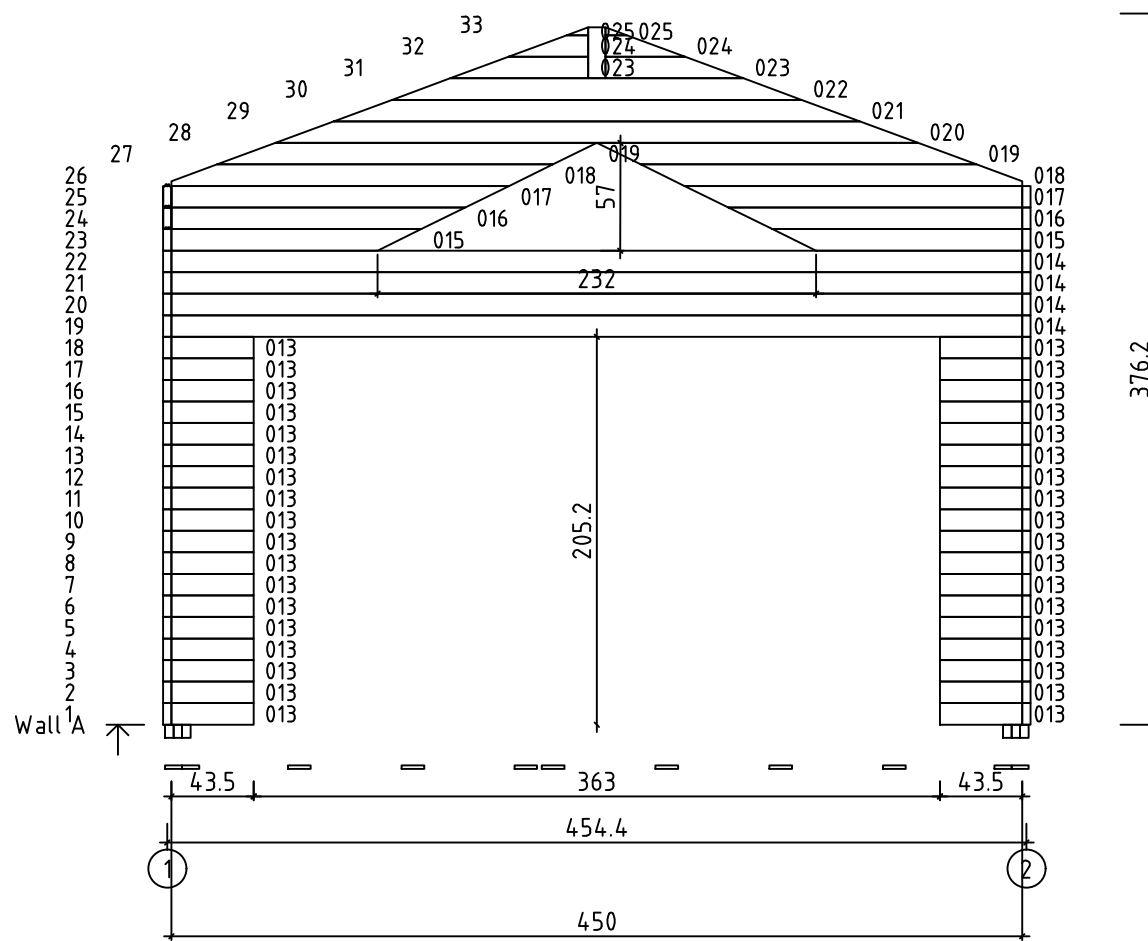

Art. Nr. 4432399

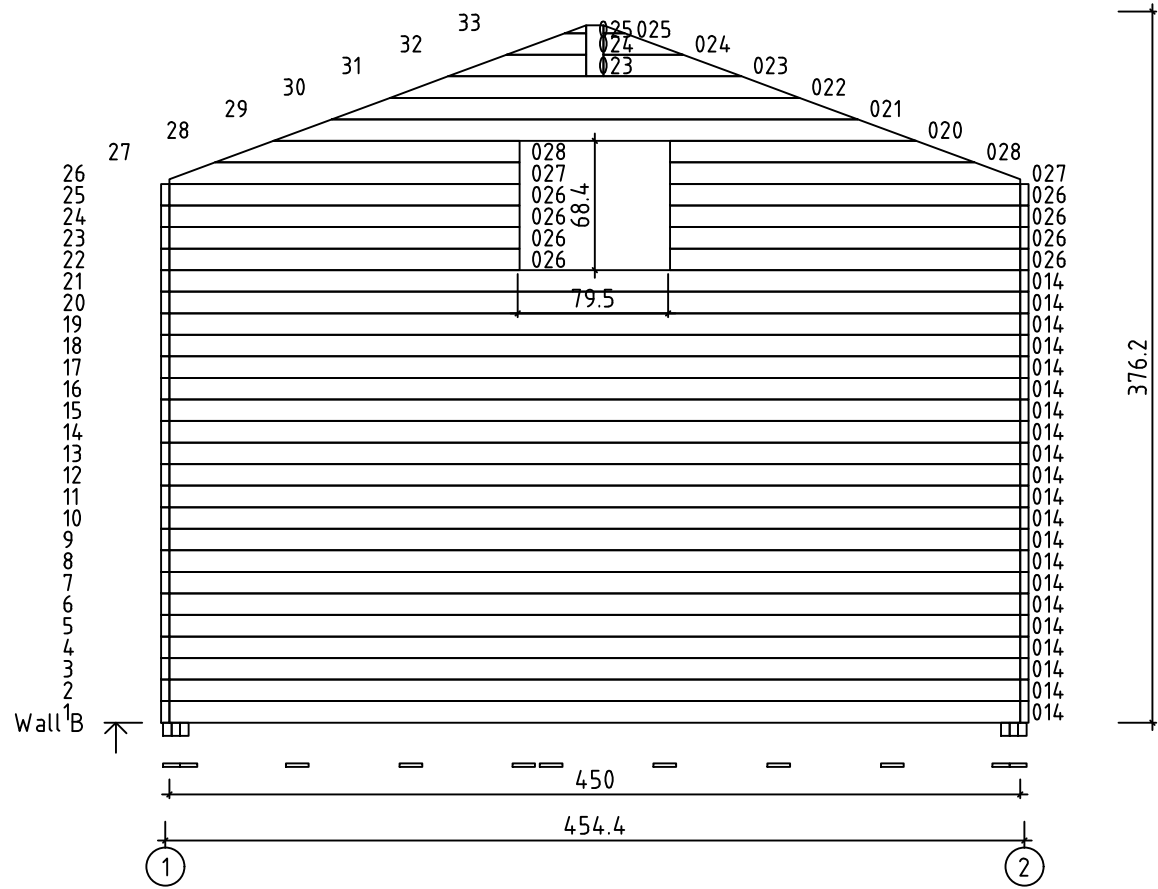

Art. Nr. 4432399

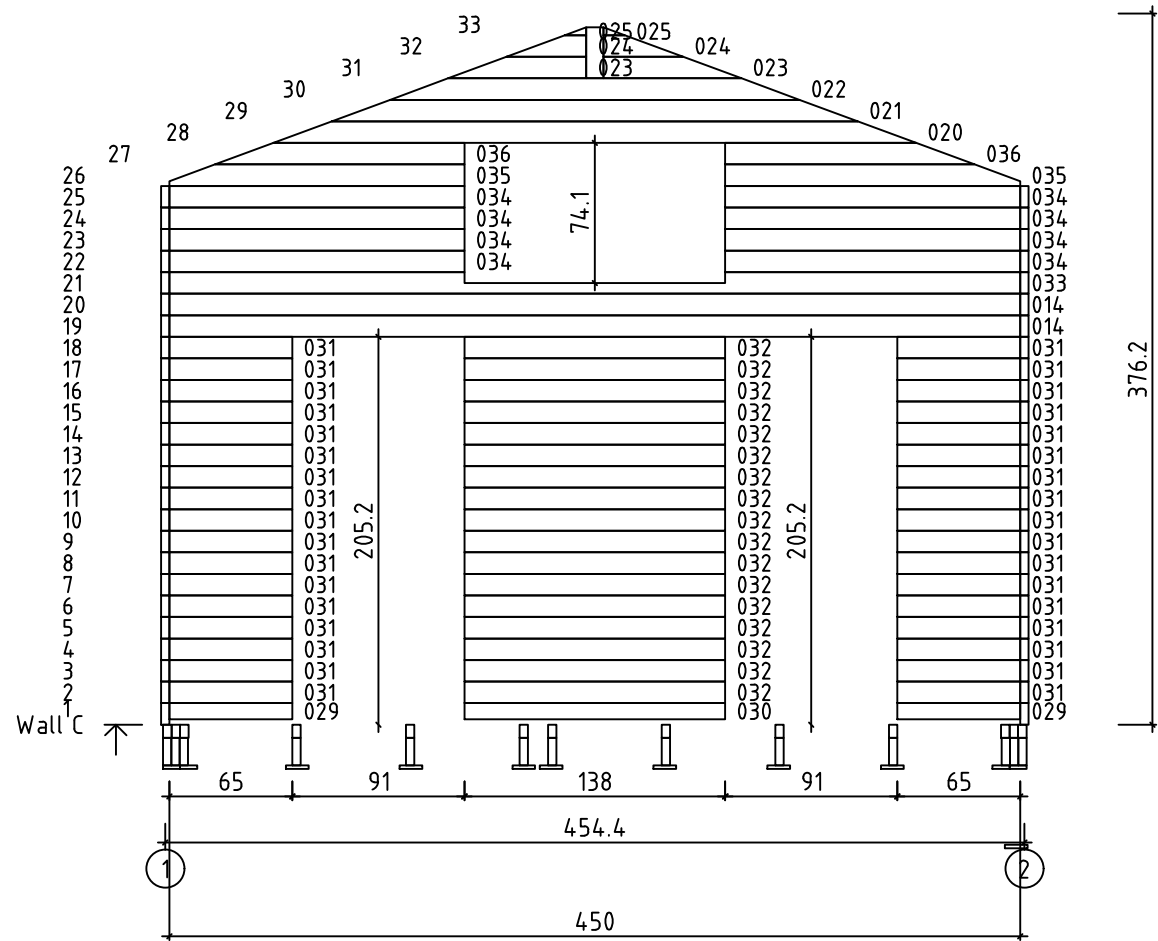

Art. Nr. 4432399

Impregnated foundation boards

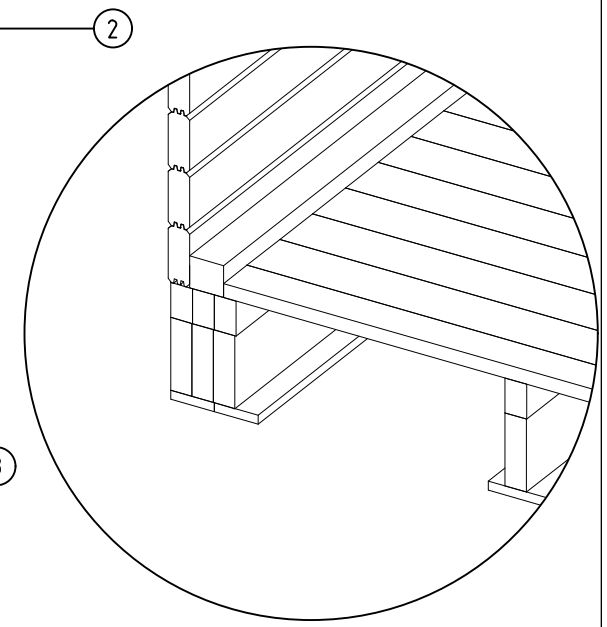
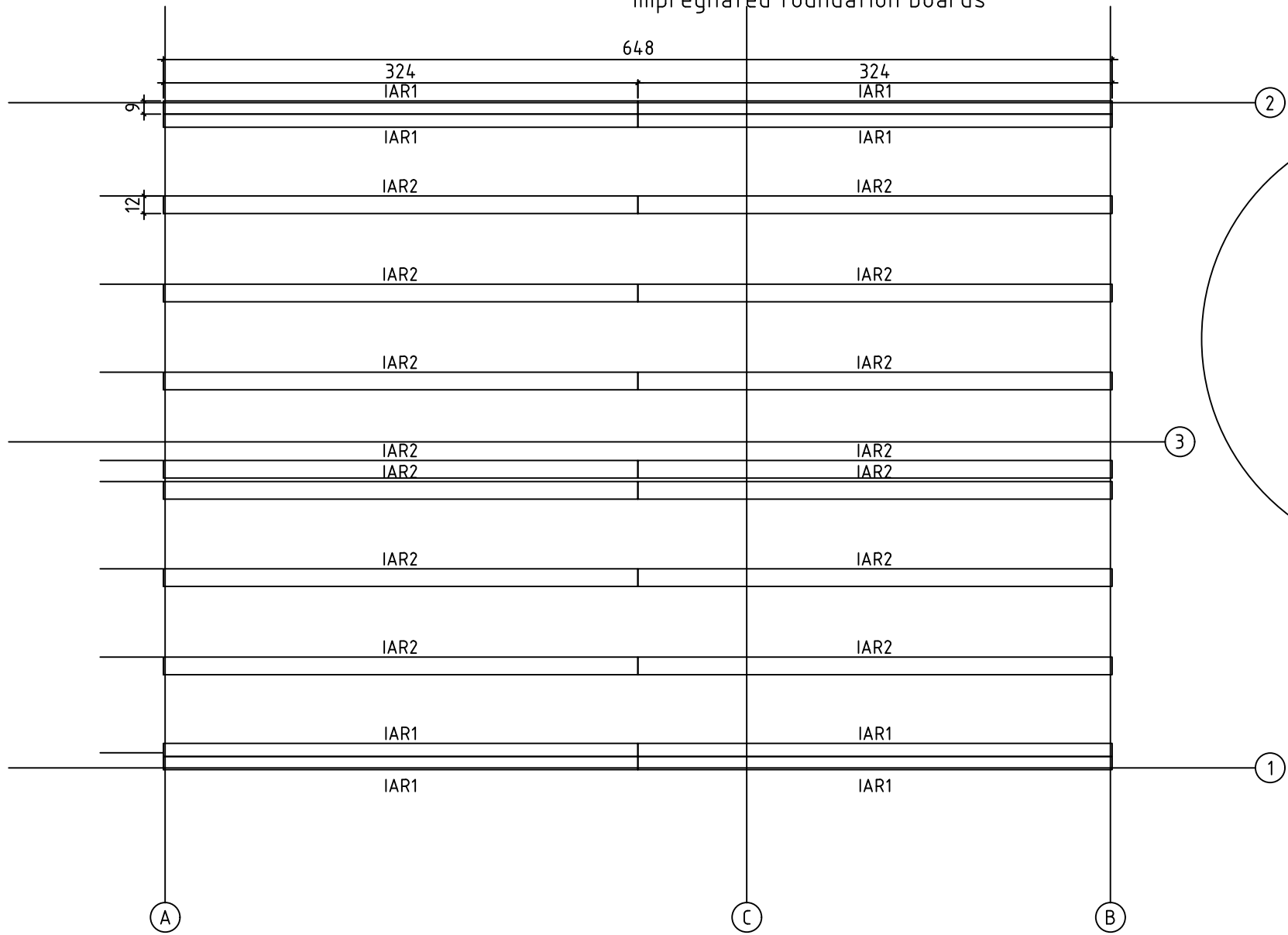

Art. Nr. 4432399

44x146 floor joists

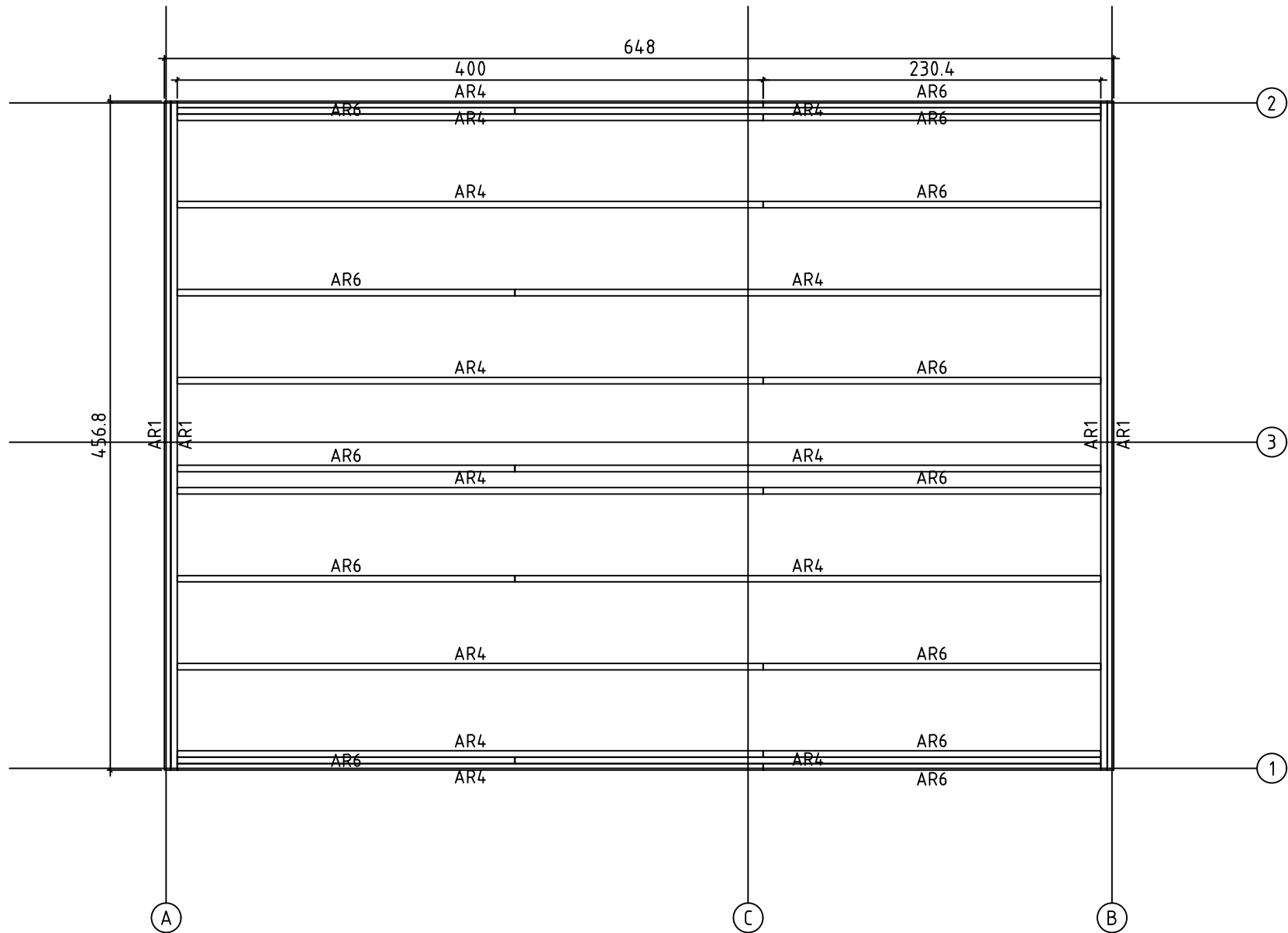

Art. Nr. 4432399

45x70 floor joists

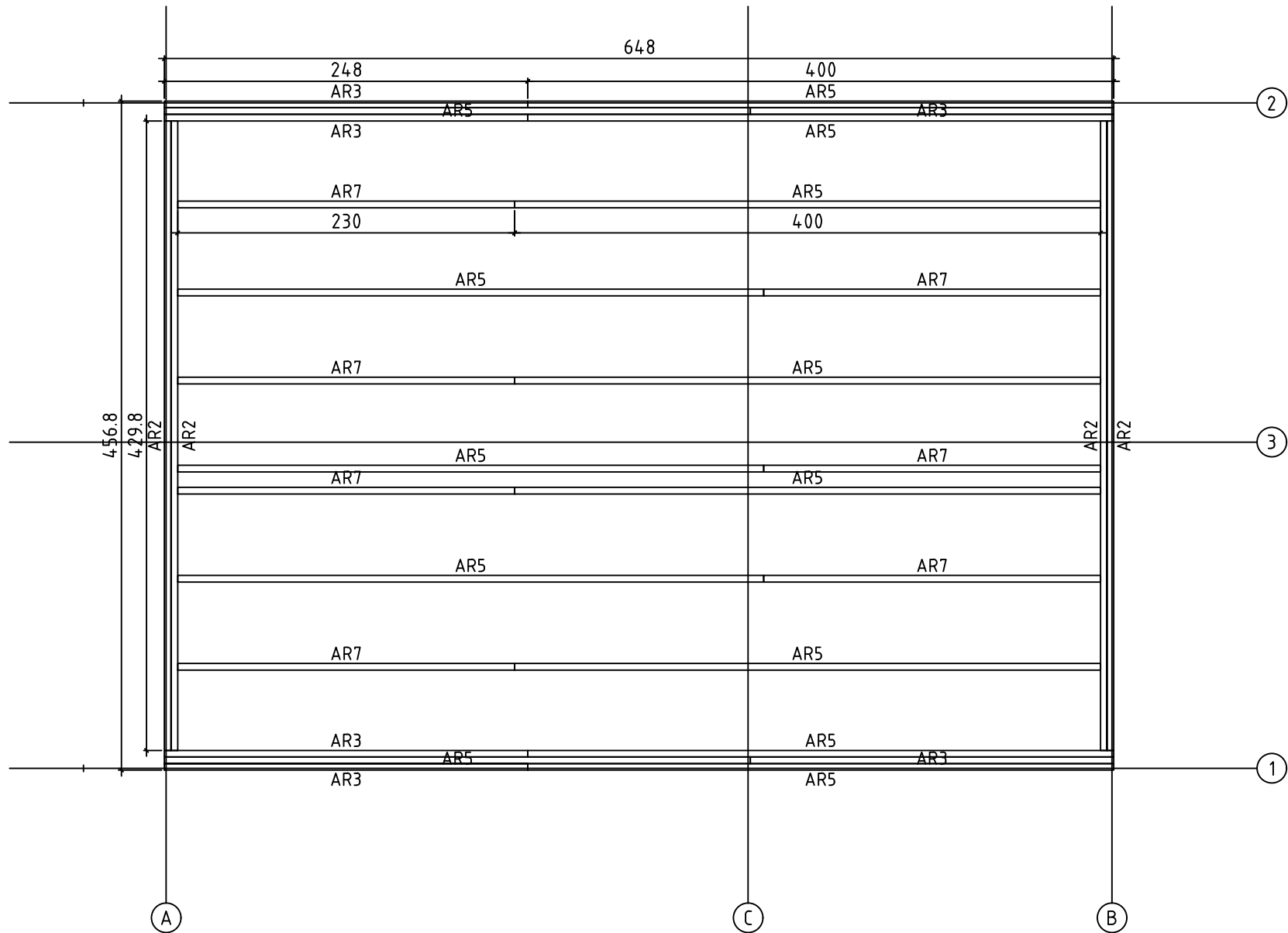

Art. Nr. 4432399

Rafters

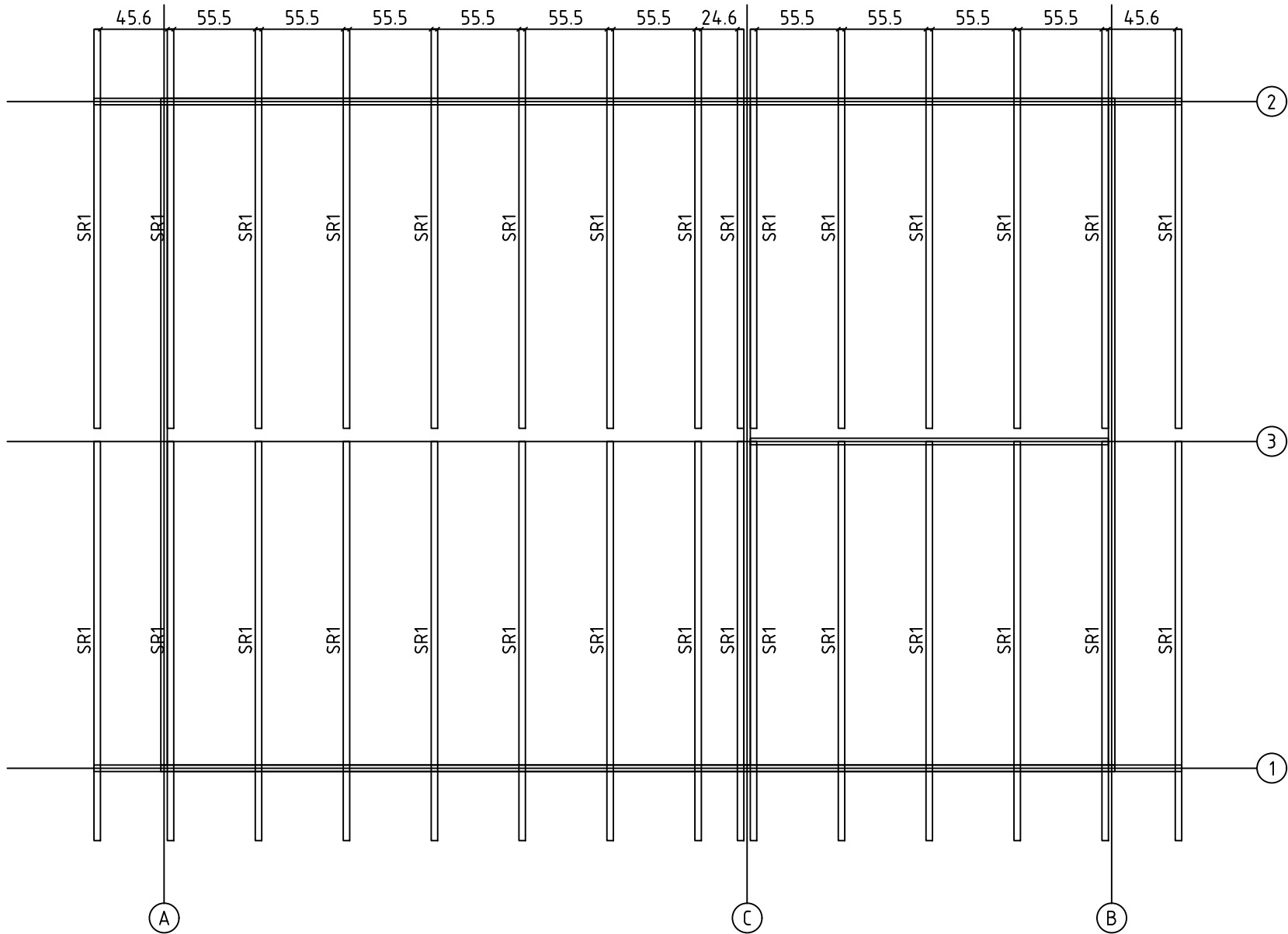

Art. Nr. 4432399

Loft beams

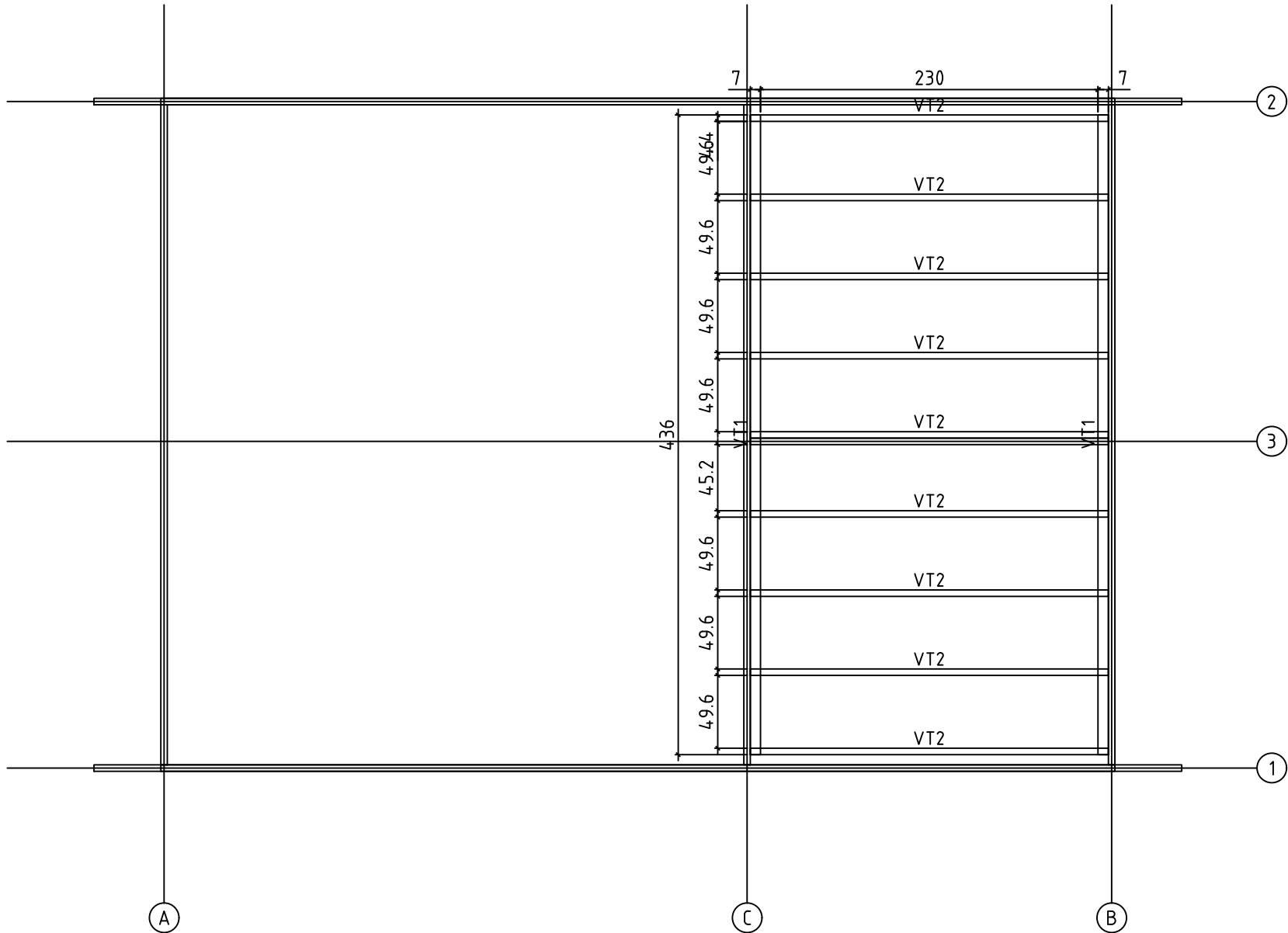

Art. Nr. 4432399



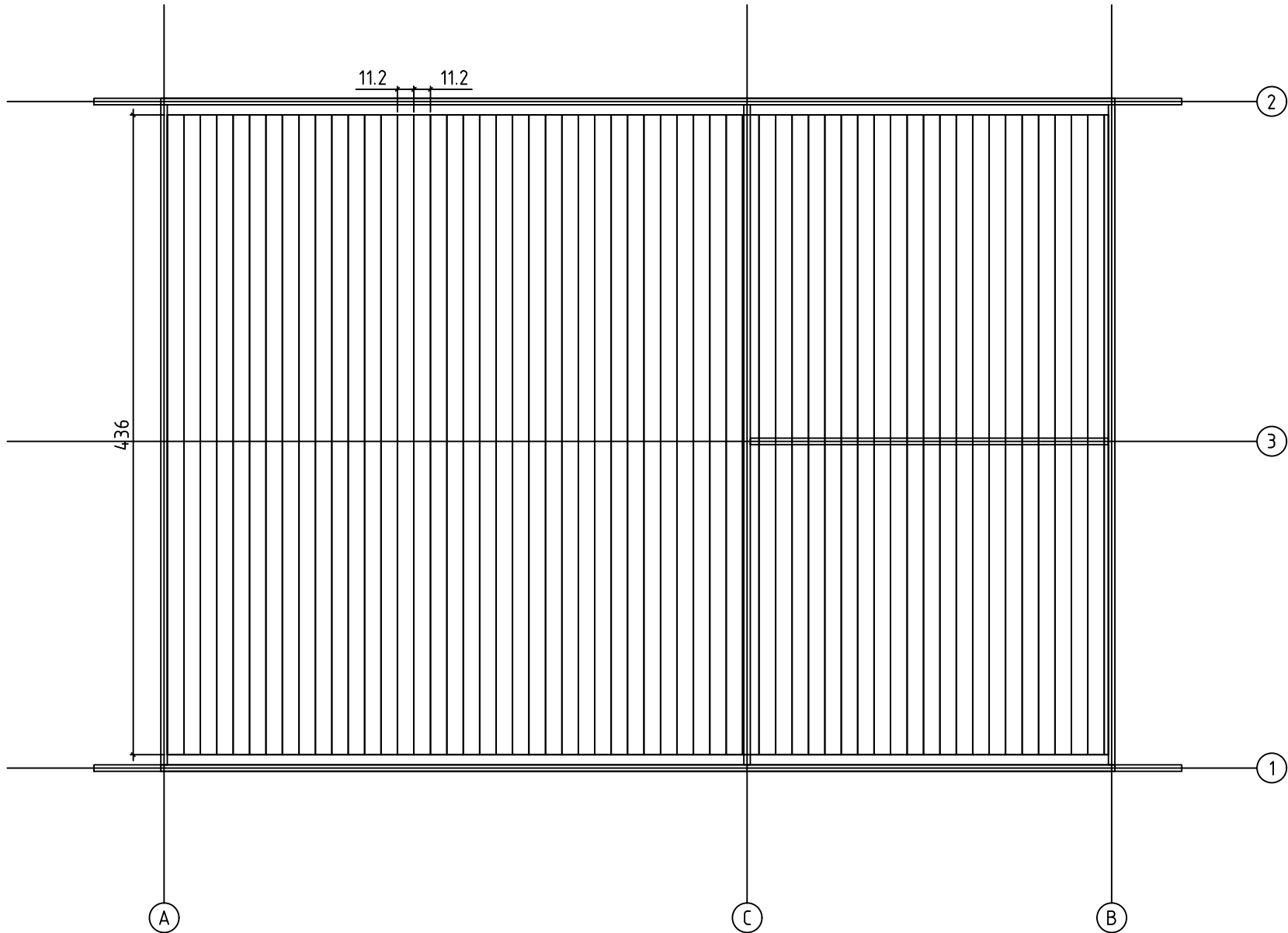





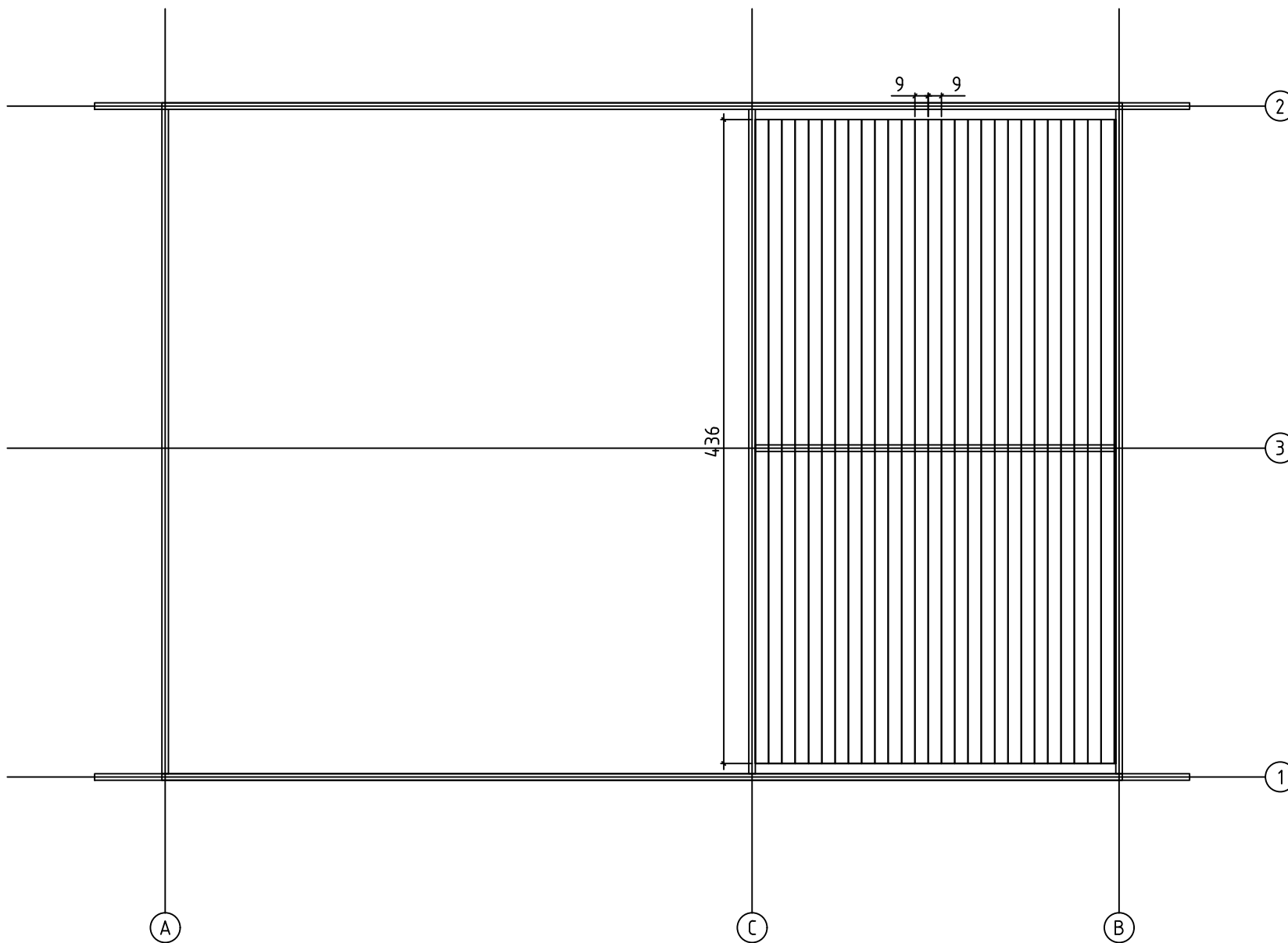

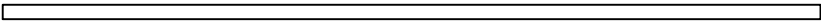
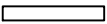
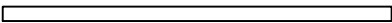
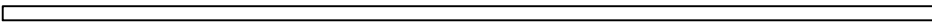



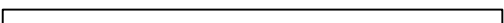

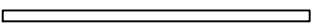
Floorboards



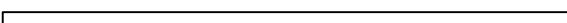
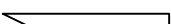
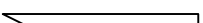
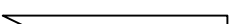
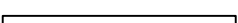

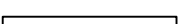

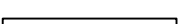



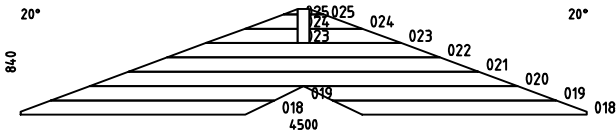
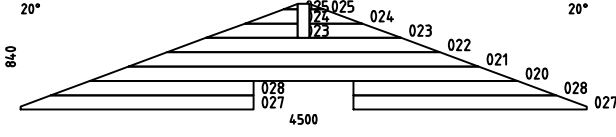
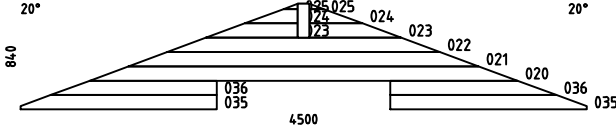
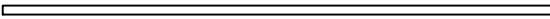
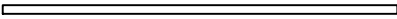
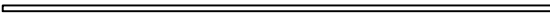
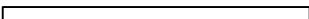

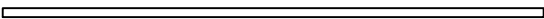
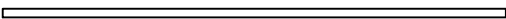
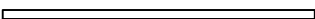



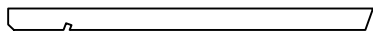
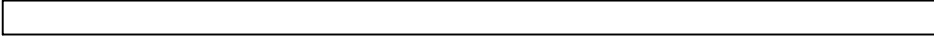





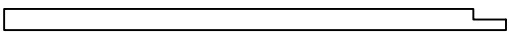
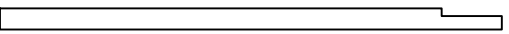

Art. Nr. 4432399

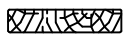
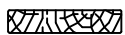
Loft floorboards

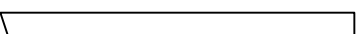
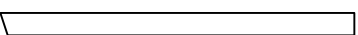

Pos	03.05.2024	PIECE LIST Art. Nr. 4432399	17/22	Q.	P (mm)	L (mm)
001				20	44x114	6500
002				12	44x114	805
003				6	44x114	3090
004				4	44x114	7412
005				4	44x114	456
006				20	44x114	555
007				24	44x114	500
008				12	44x114	3970
009				6	44x114	2340
010				1	44x86	2440
011				18	44x114	2440
012				1	44x114	2440
013				36	44x114	435
014				27	44x114	4500
015				2	44x114	1322
016				2	44x114	1554
017				2	44x114	1786
026				8	44x114	1853
029				2	44x86	650
030				1	44x86	1380
031				34	44x114	650
032				17	44x114	1380
033				1	44x114	4500

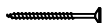
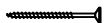
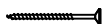
Pos	03.05.2024	PIECE LIST Art. Nr. 4432399	18/22	Q.	P (mm)	L (mm)
034				8	44x114	1560
WA-1				1		
WB-1				1		
WC-1				1		
PT1	FLOOR FILLET 			4	70x70	4360
PT2				6	70x70	3136
VT1	MEZZANINE FLOOR JOISTS 			2	70x45	4360
VT2	MEZZANINE FLOOR JOISTS 			9	44x146	2440
IAR2	FOUNDATION 			14	120x18	3240
IAR1	FOUNDATION 			8	90x18	3240
AR2	FOUNDATION 			4	45x70	4298
AR5	FOUNDATION 			13	45x70	4000
AR3	FOUNDATION 			6	45x70	2480
AR7	FOUNDATION 			7	45x70	2300
AR1	FOUNDATION 			4	44x146	4568
AR4	FOUNDATION 			13	44x146	4000
AR6	FOUNDATION 			13	44x146	2304
SR1	RAFTER 			30	44x170	2900
A-PR1	ROOF BEAM 			1	90x270	7412
HLL-1	FLOOR BOARDS 			58	112x28	4360

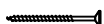
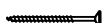
Pos	03.05.2024	PIECE LIST Art. Nr. 4432399	19/22	Q.	P (mm)	L (mm)
FB-1	FLOOR BOARDS		28	90x18.5	4360	
RB-1	ROOF BOARDS		66	90x18.5	5093	
RB-2	ROOF BOARDS		66	90x18.5	2319	
RFF	ROOFING FELT FILLET		4	18x58	3050	
RS1	RAILING STRIP		4	18x120	2850	
RS2	RAILING STRIP		4	18x120	2850	
P1	POST		2	70x70	2061	
P2	POST		8	70x70	2700	
TB1	EAVES BOARD		4	18x90	3517	
TB2	EAVES BOARD		4	18x90	3895	
UT-1	U-PROFILE		2	35x70	740	
UT-2	U-PROFILE		1	35x70	1400	
GL1	GABLE MOULDING		8	18x120	3050	
GL2	GABLE MOULDING		4	18x140	3050	
	LADDER		1			
HS8	SCREW		400	3.5x35		
HS9	SCREW		250	3.5x50		
HSx	SCREW		500	3.9x70		
HS13	SCREW		40	4x60		
HS18	SCREW		60	5x120		
HS16	SCREW		1000	5x90		
HS23	SCREW		250	6x180		
HS26	SCREW		400	5x40		

Art. Nr. 4432399

U.3TV.b 900x1990

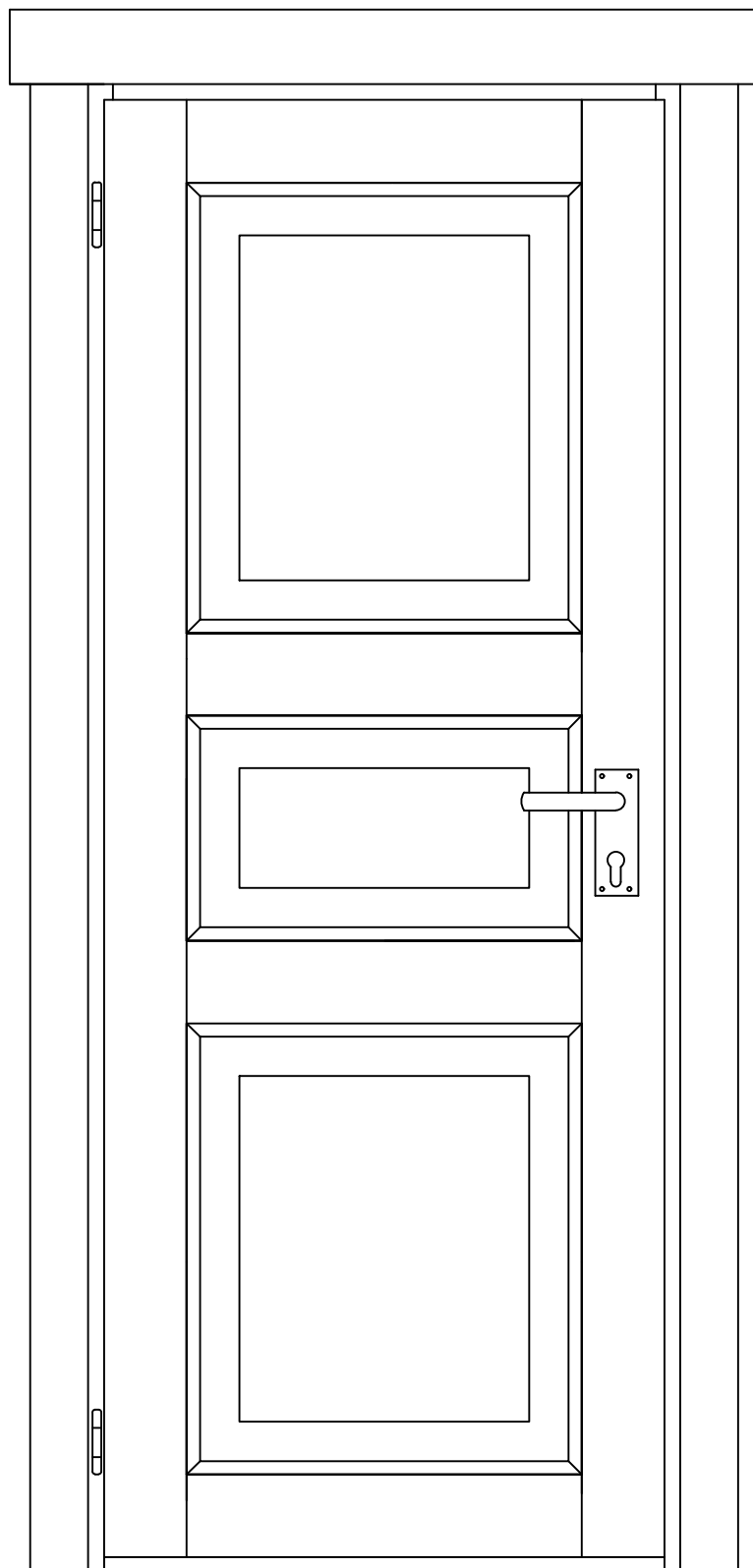

Art. Nr. 4432399

U.3TP.b 900x1990

