

Art. Nr. 4432599

1/22

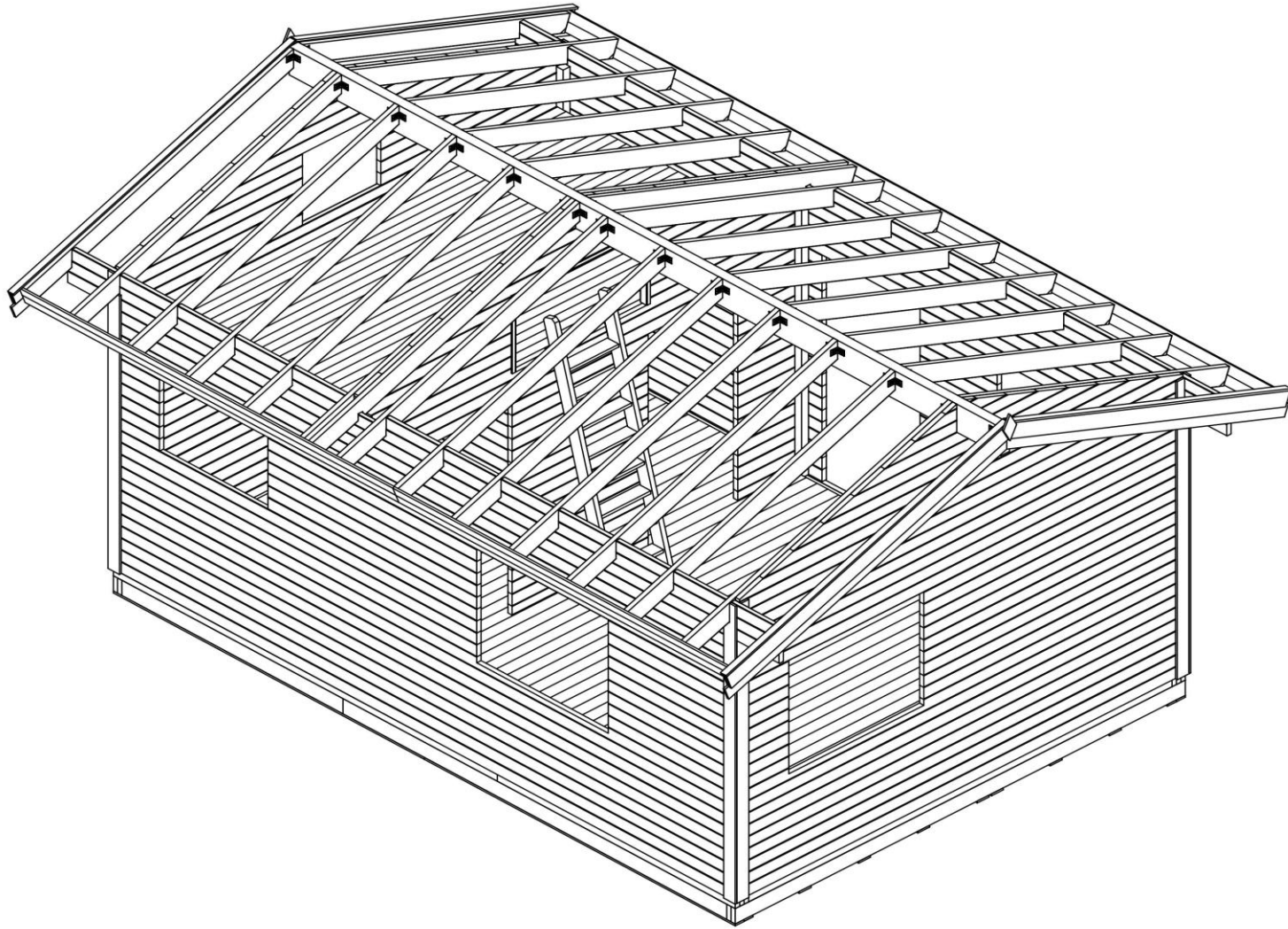

06.05.2024

Art. Nr. 4432599

Groundplan version 1

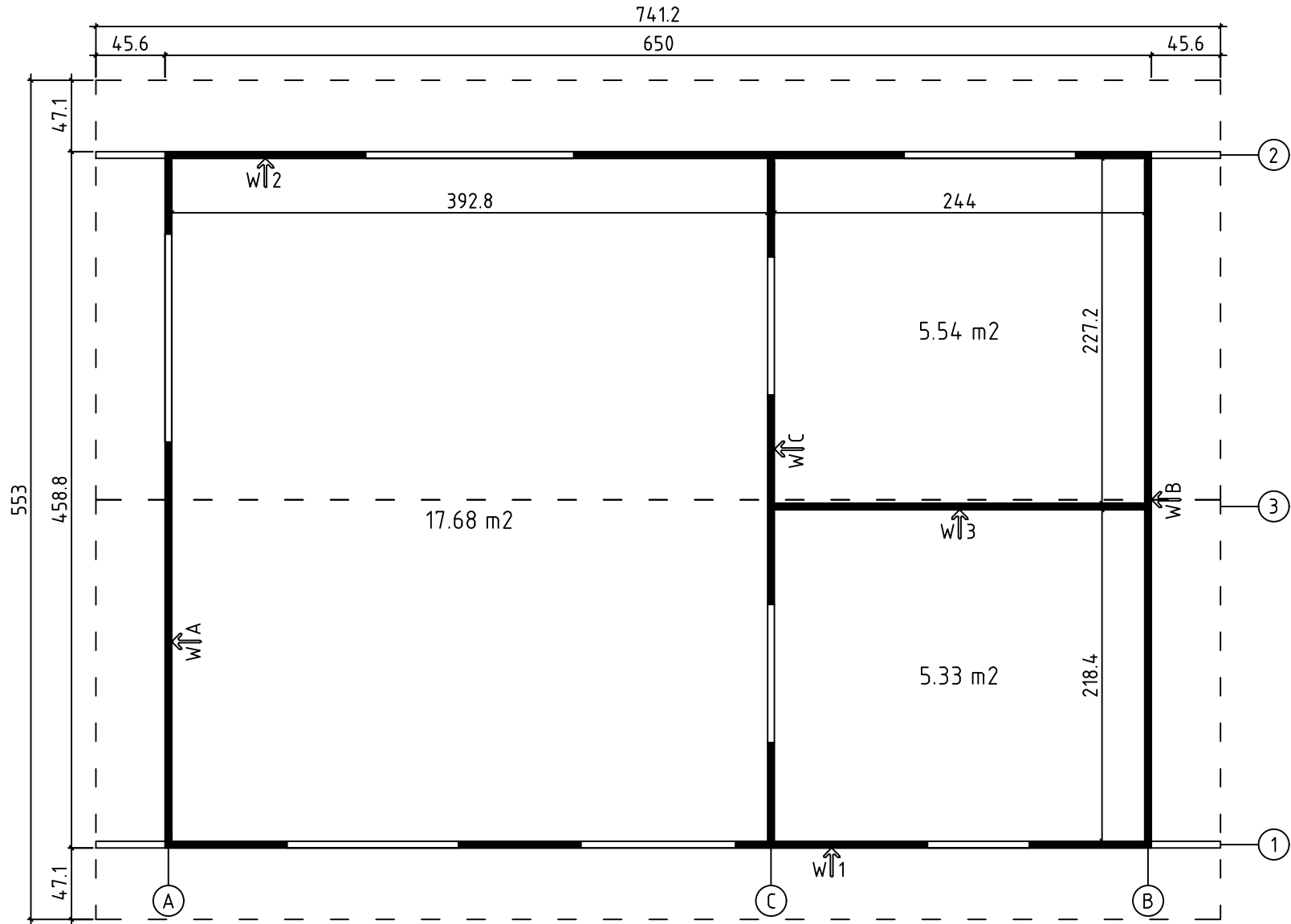

Art. Nr. 4432599

Groundplan version 2

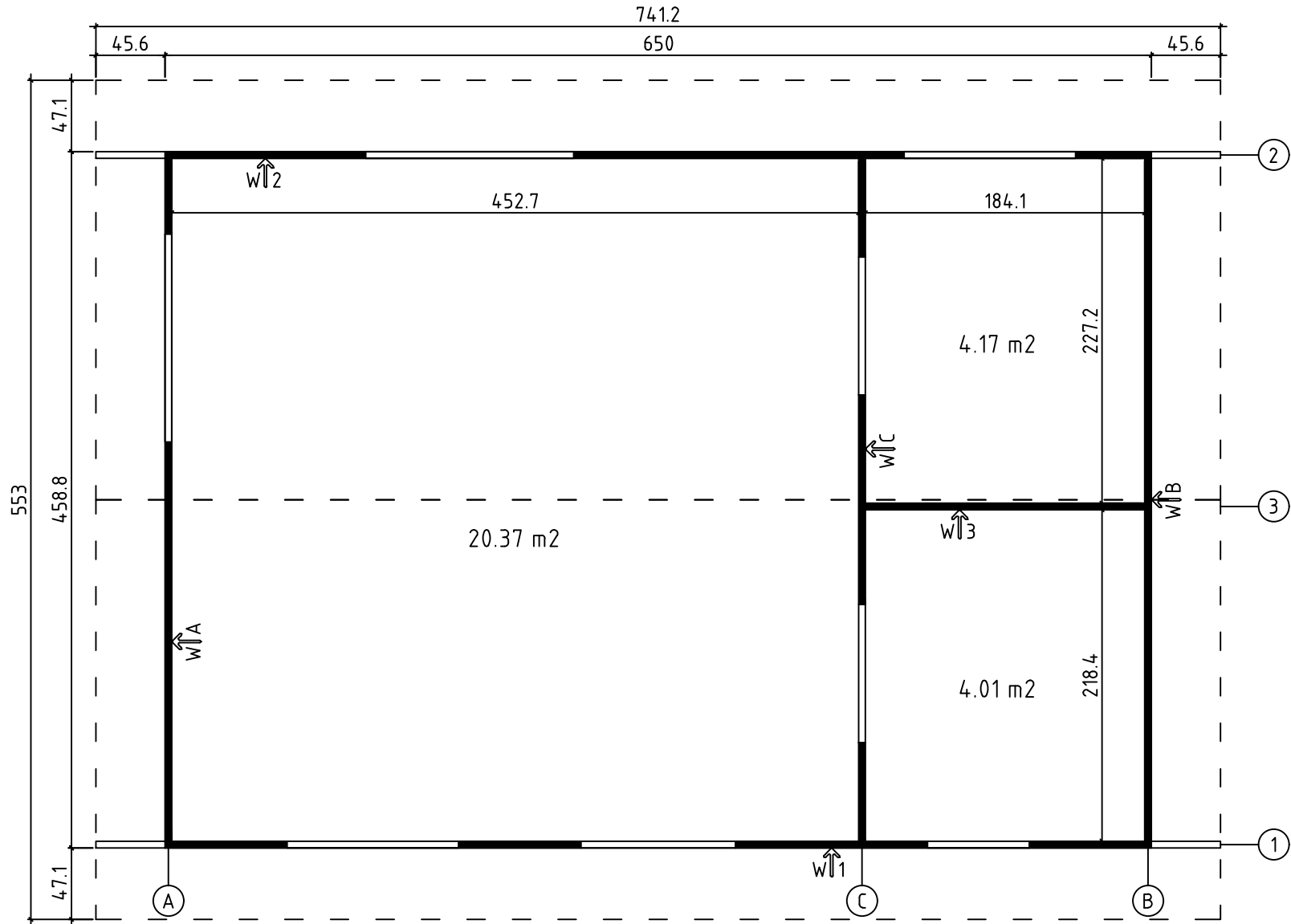

Art. Nr. 4432599

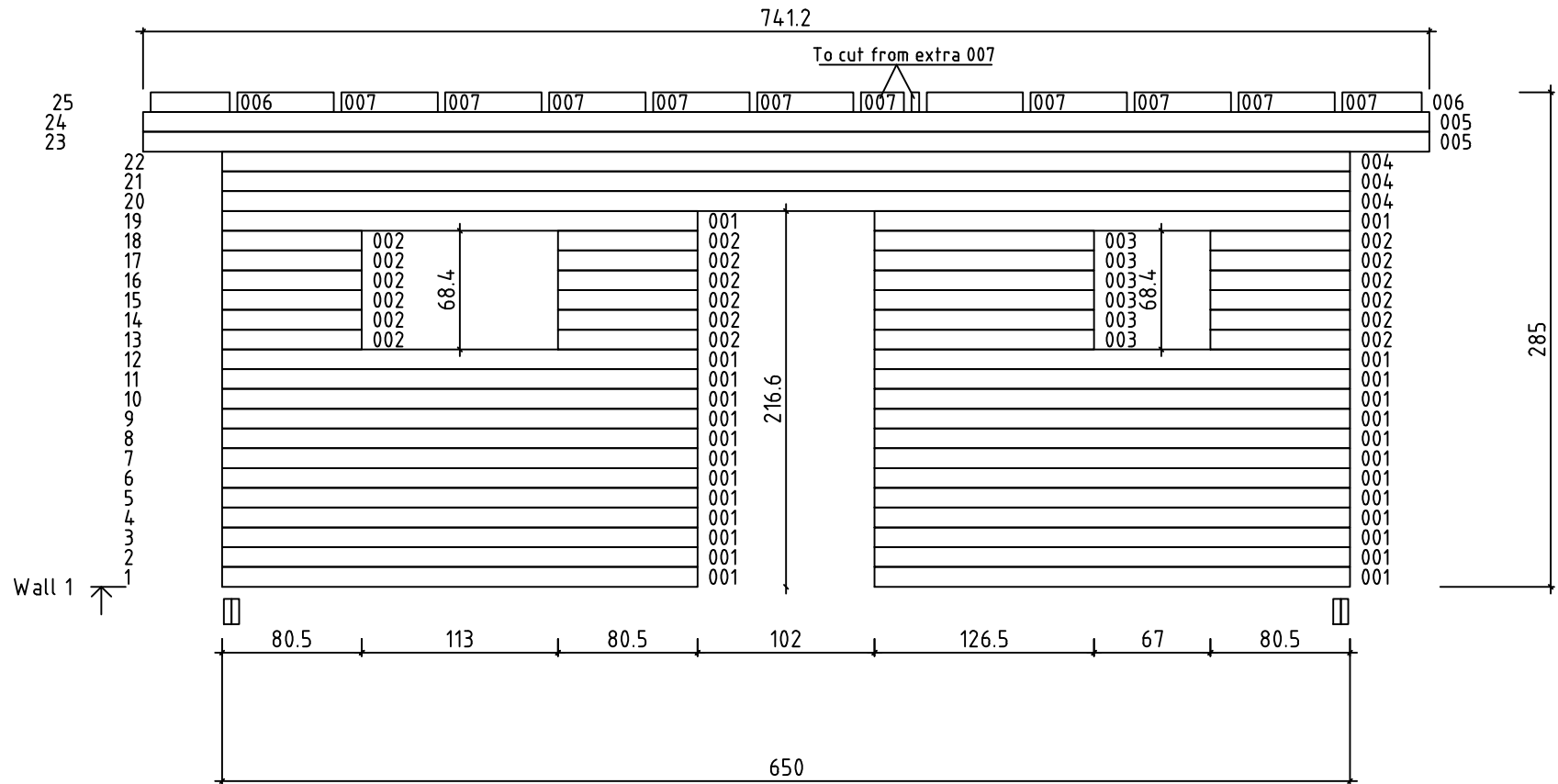

Art. Nr. 4432599

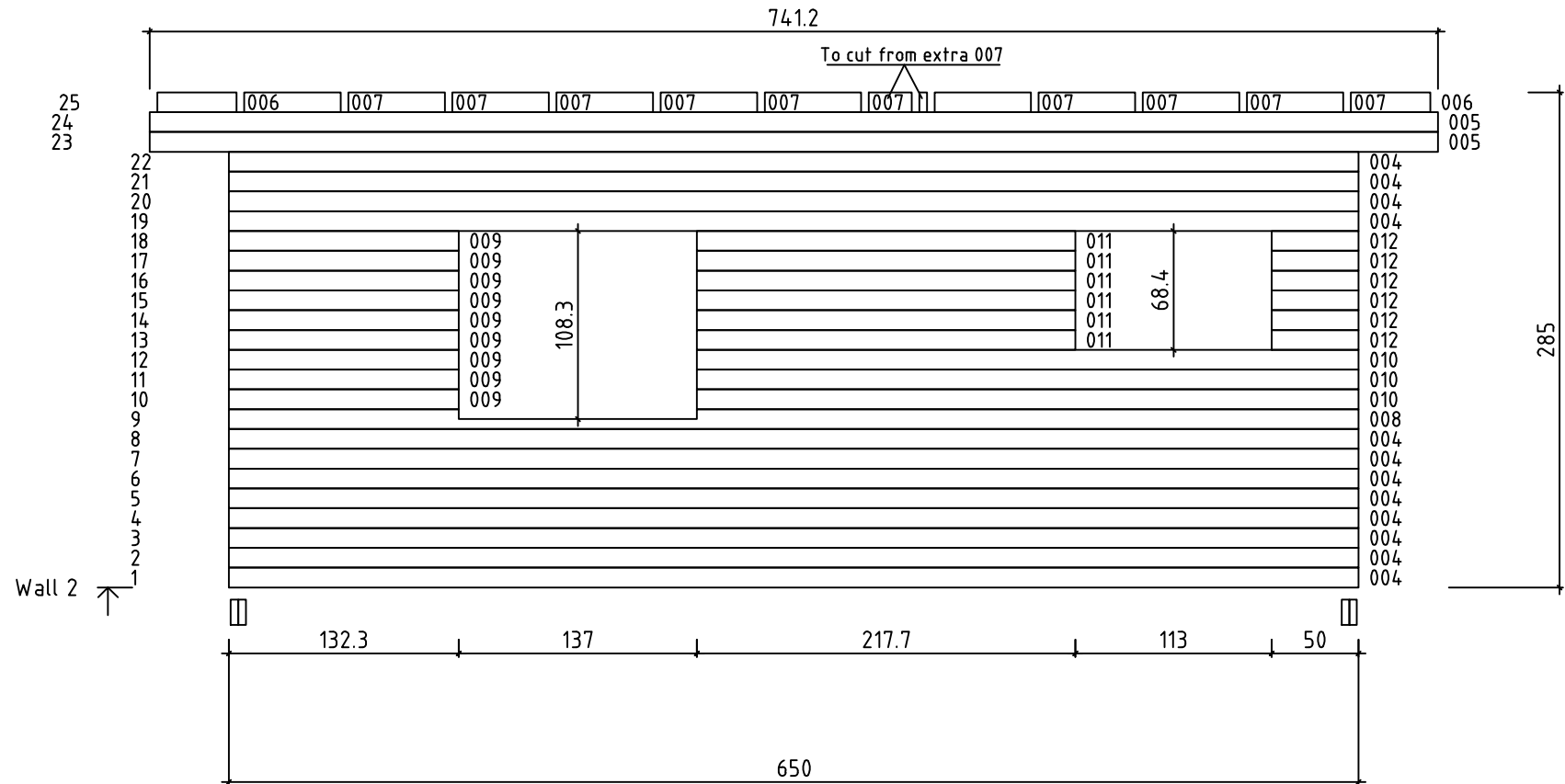

Art. Nr. 4432599

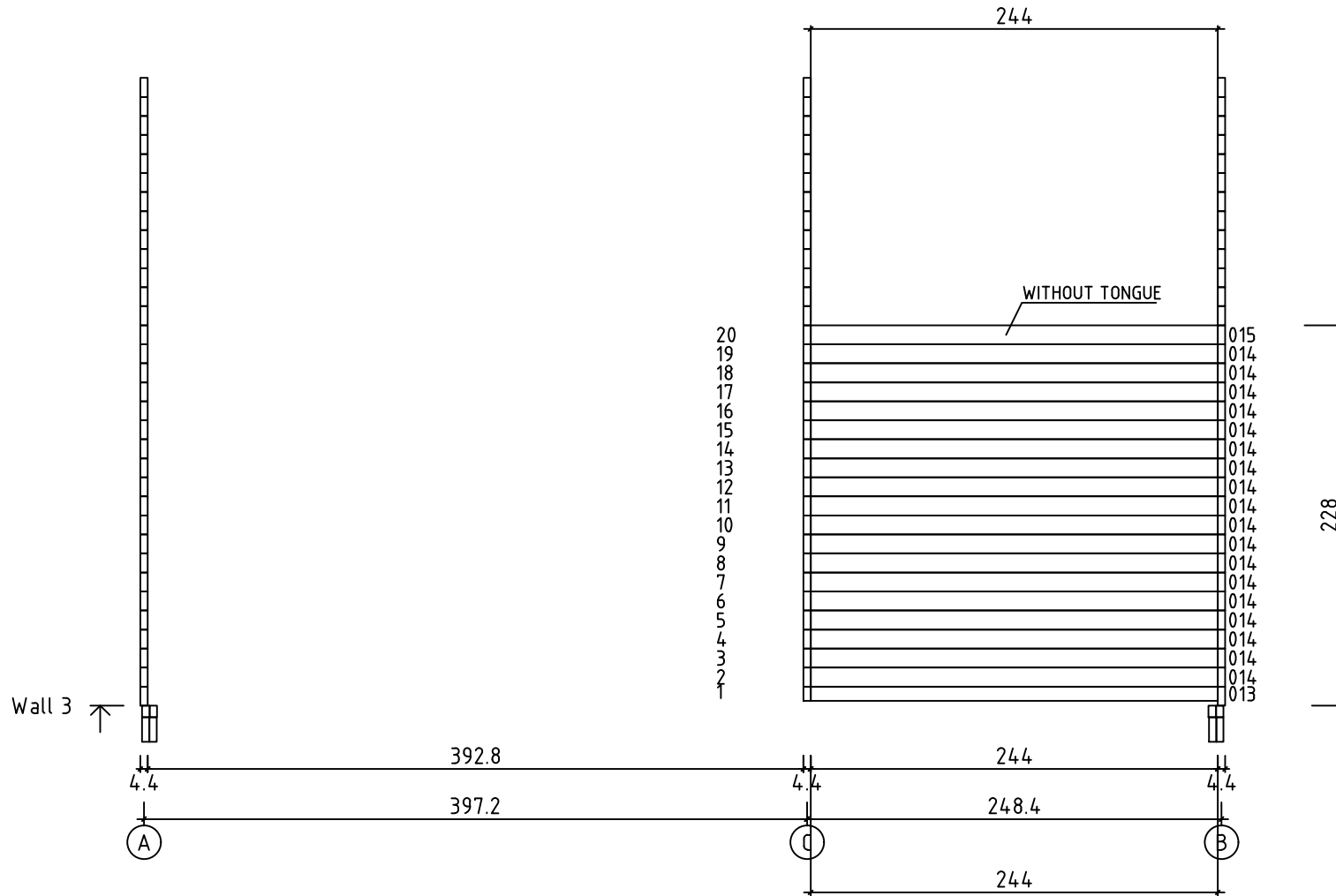

Art. Nr. 4432599

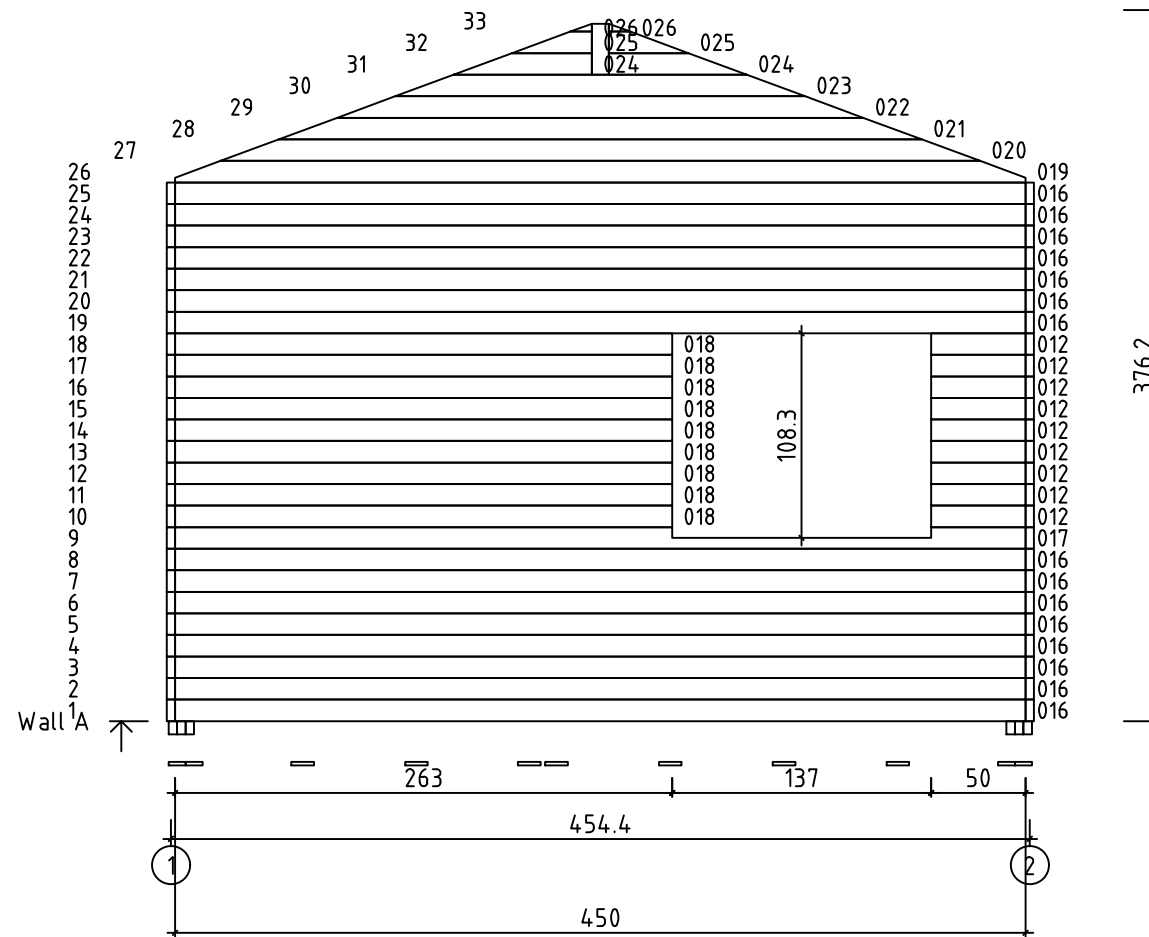

Art. Nr. 4432599

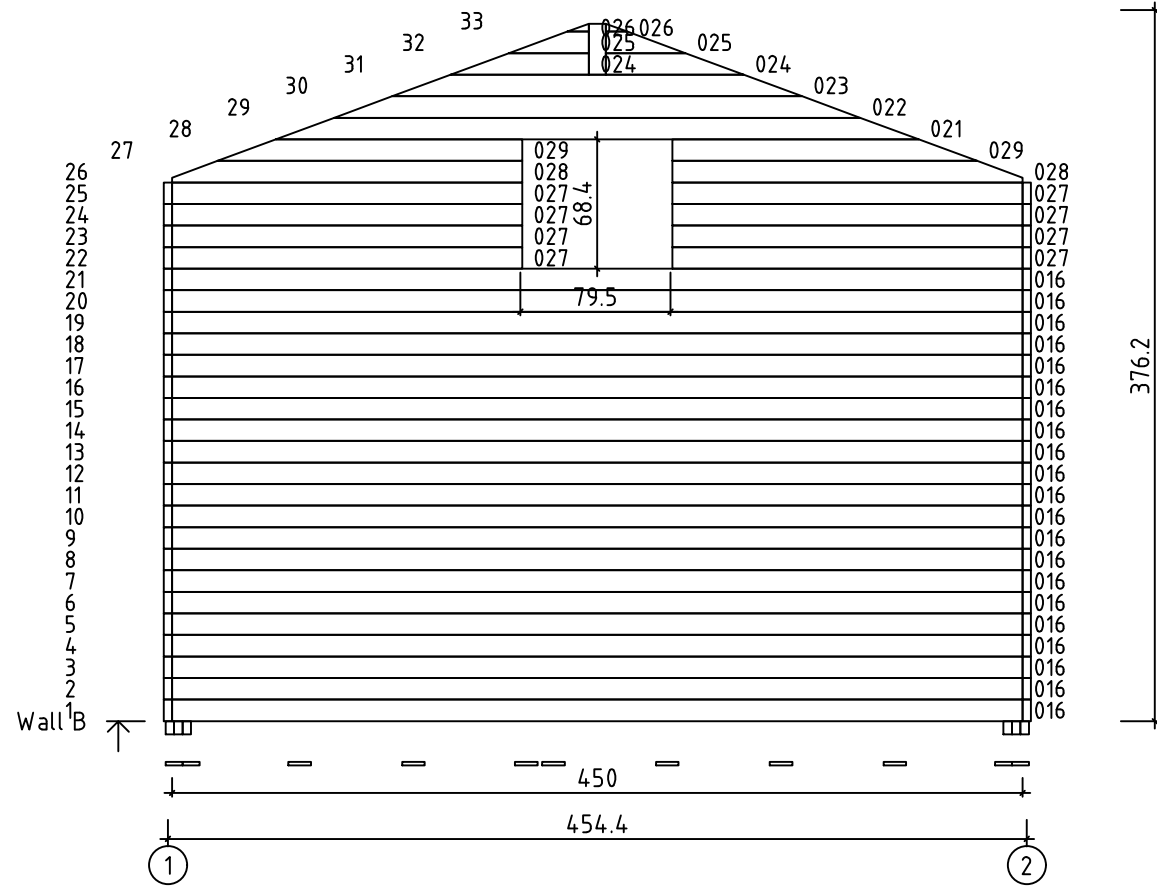

Art. Nr. 4432599

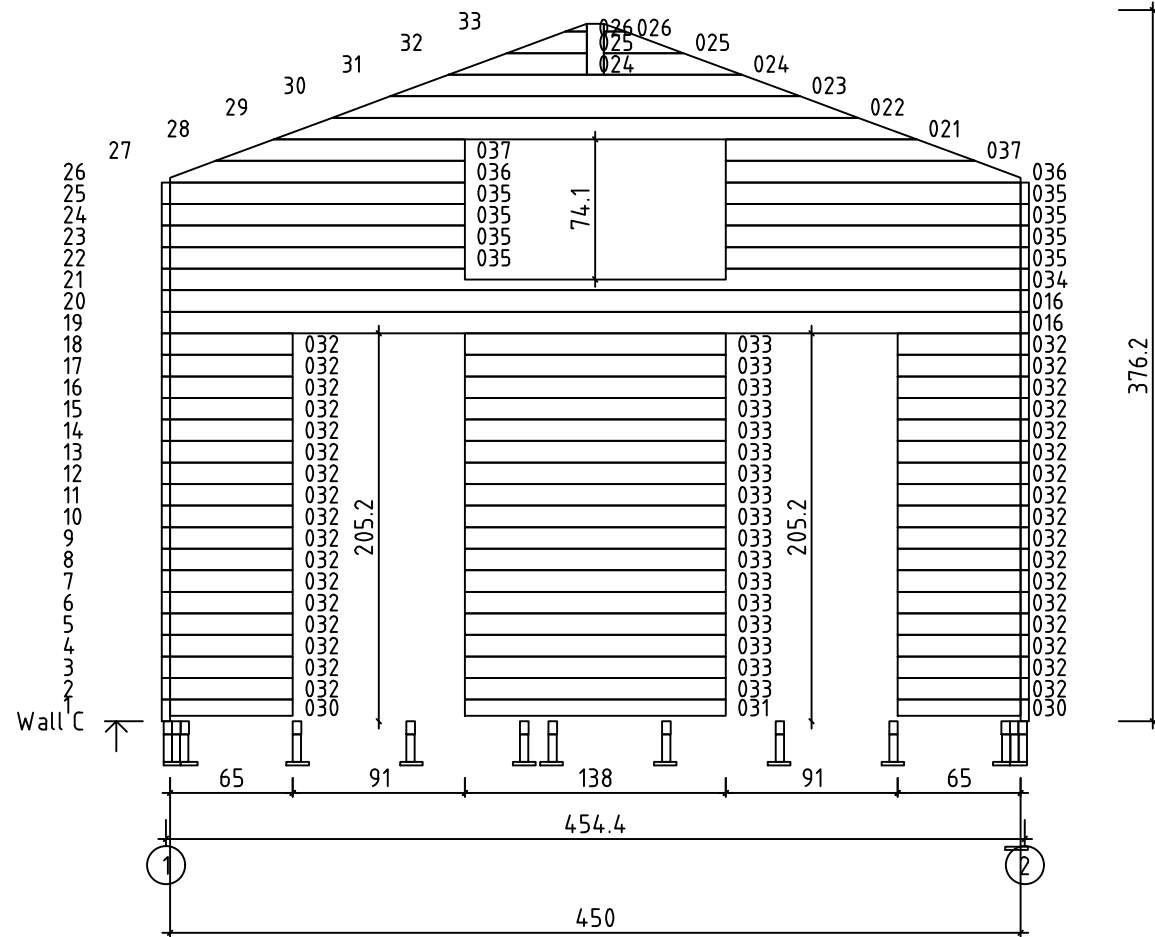

Art. Nr. 4432599

Impregnated foundation boards

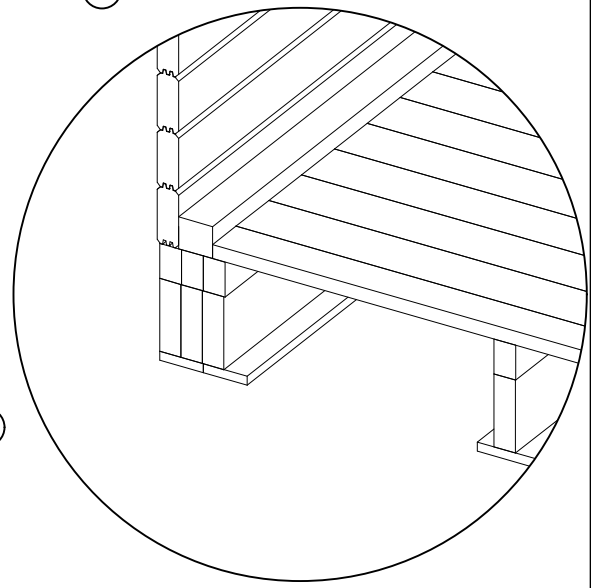
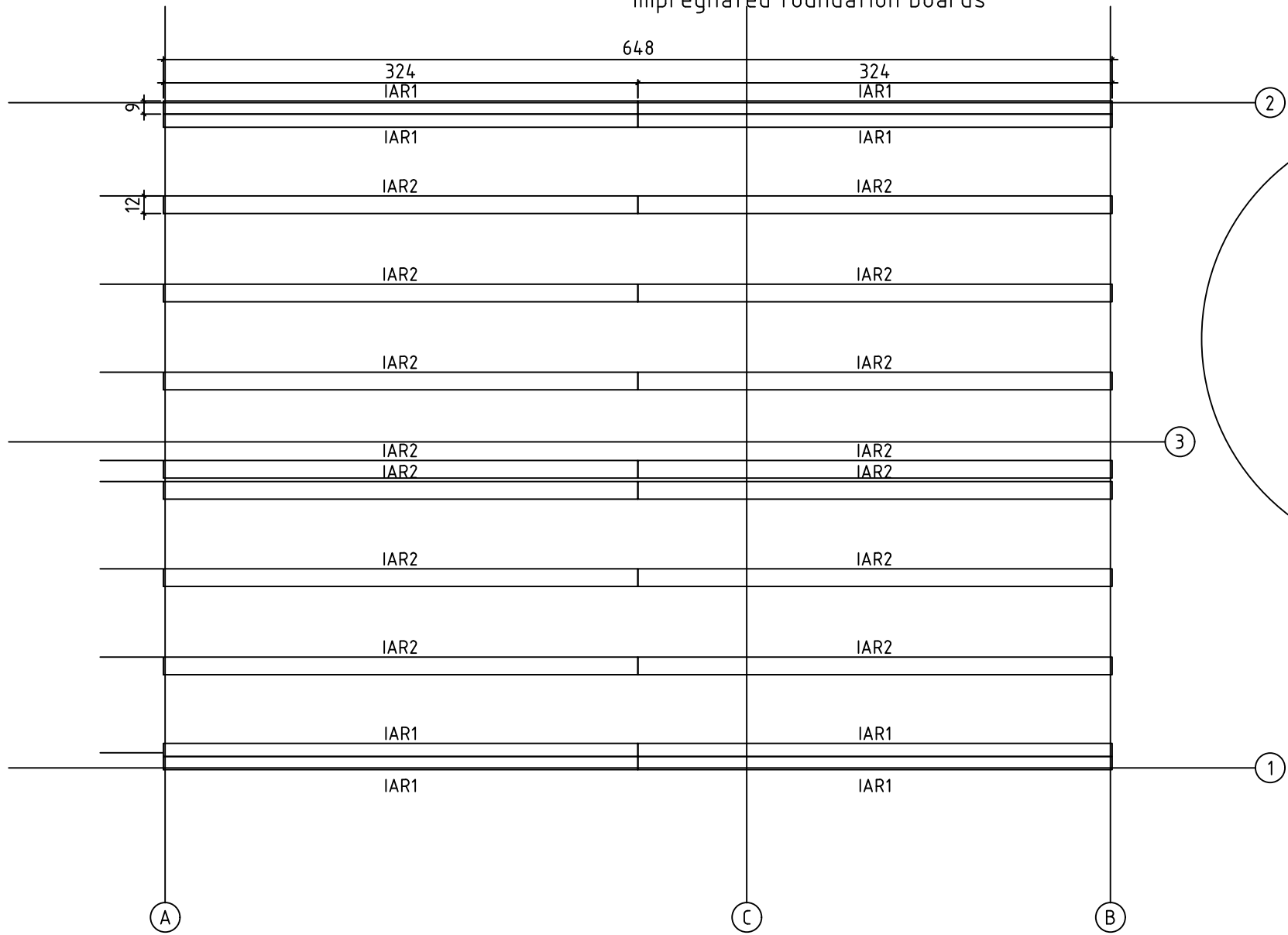

Art. Nr. 4432599

44x146 floor joists

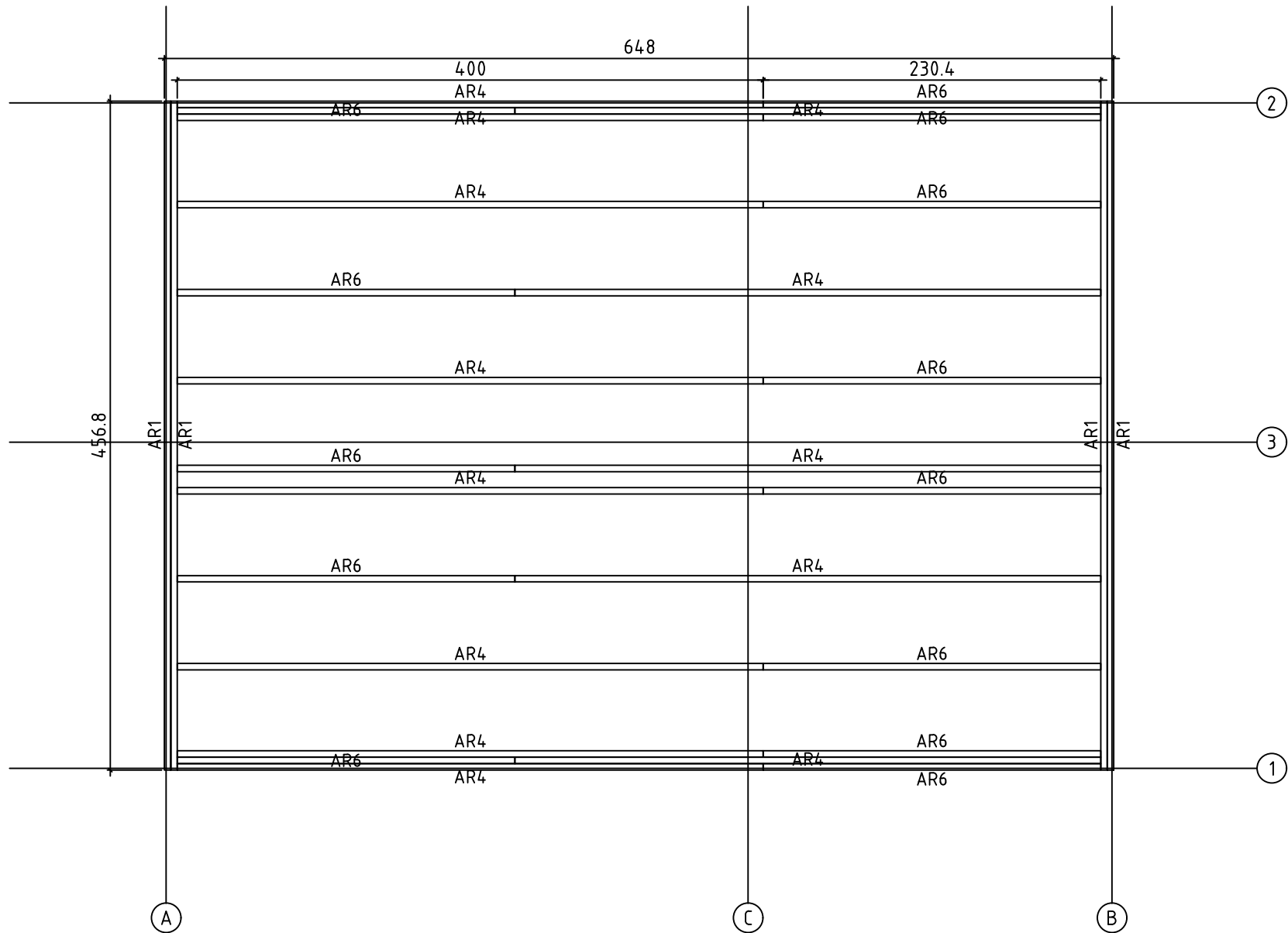

Art. Nr. 4432599

45x70 floor joists

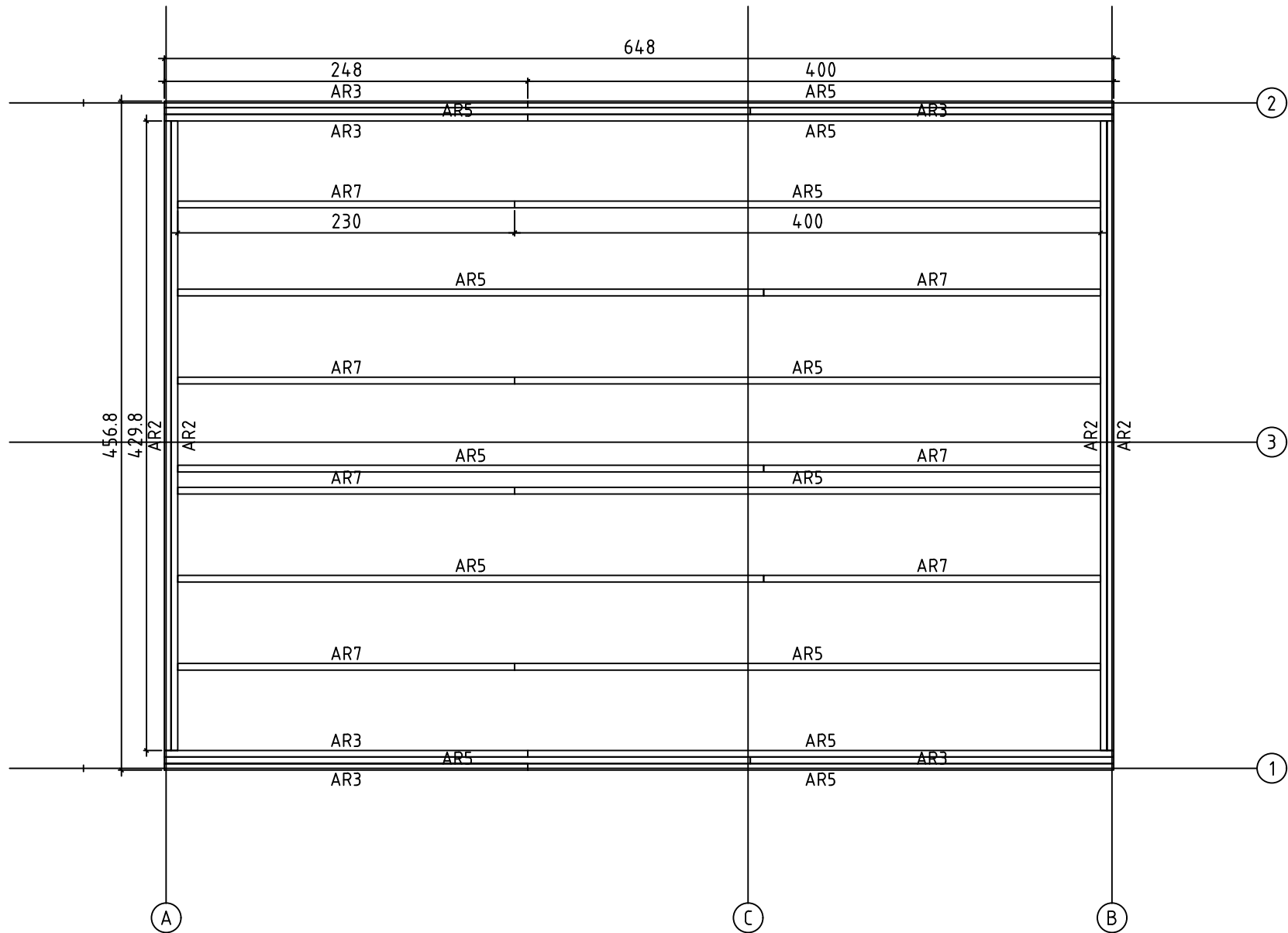

Art. Nr. 4432599

Rafters

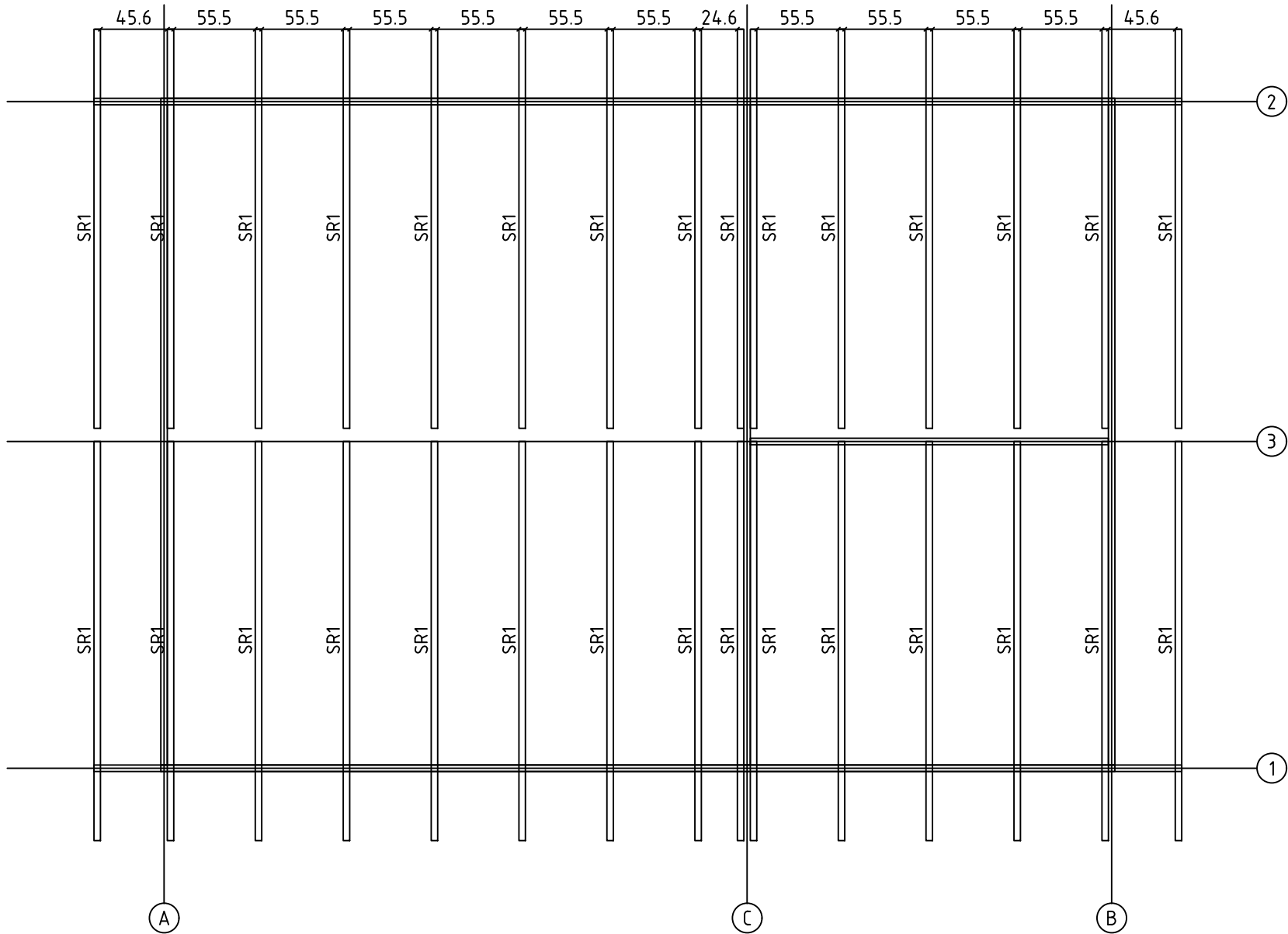

Art. Nr. 4432599

Loft beams

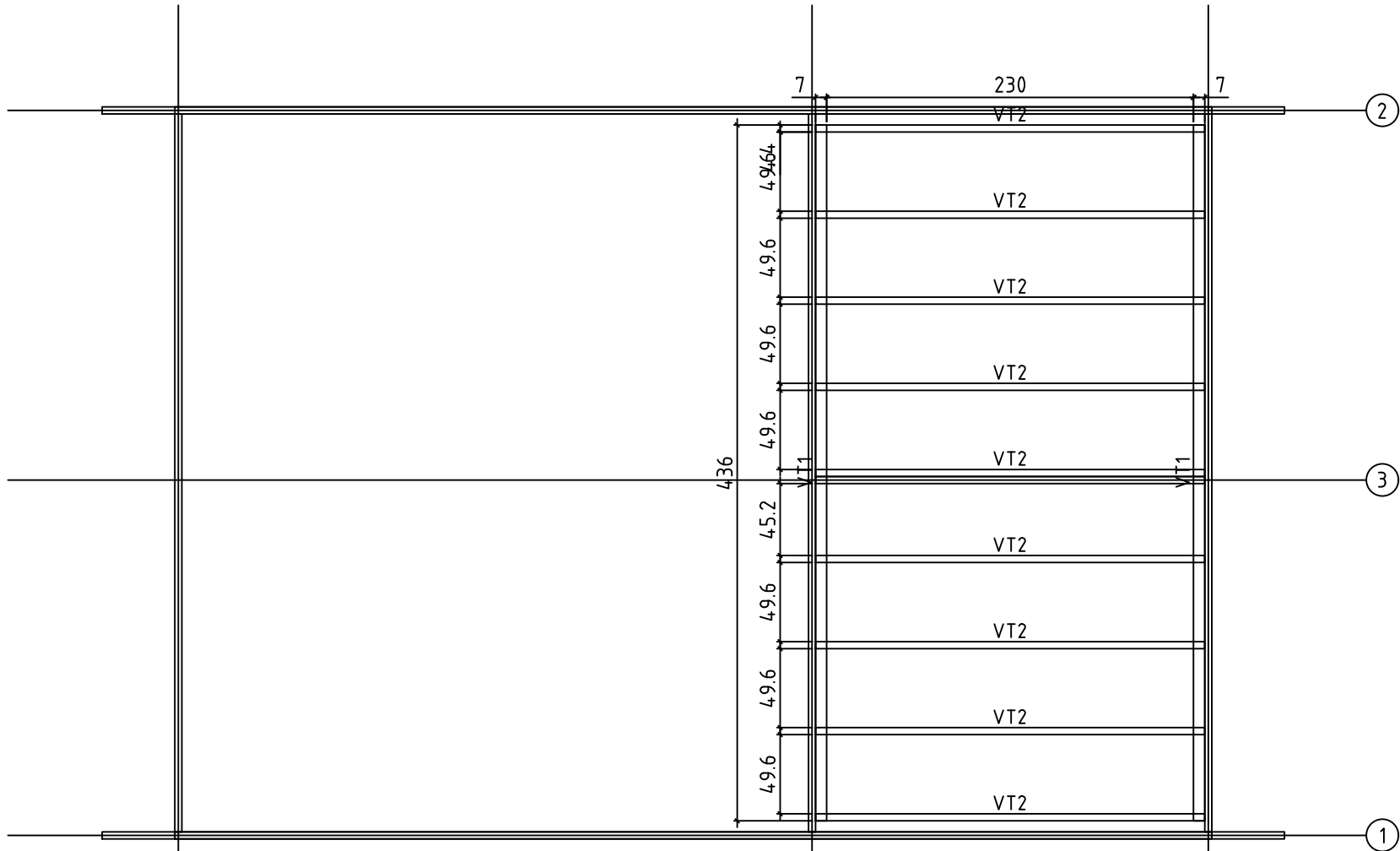

Art. Nr. 4432599



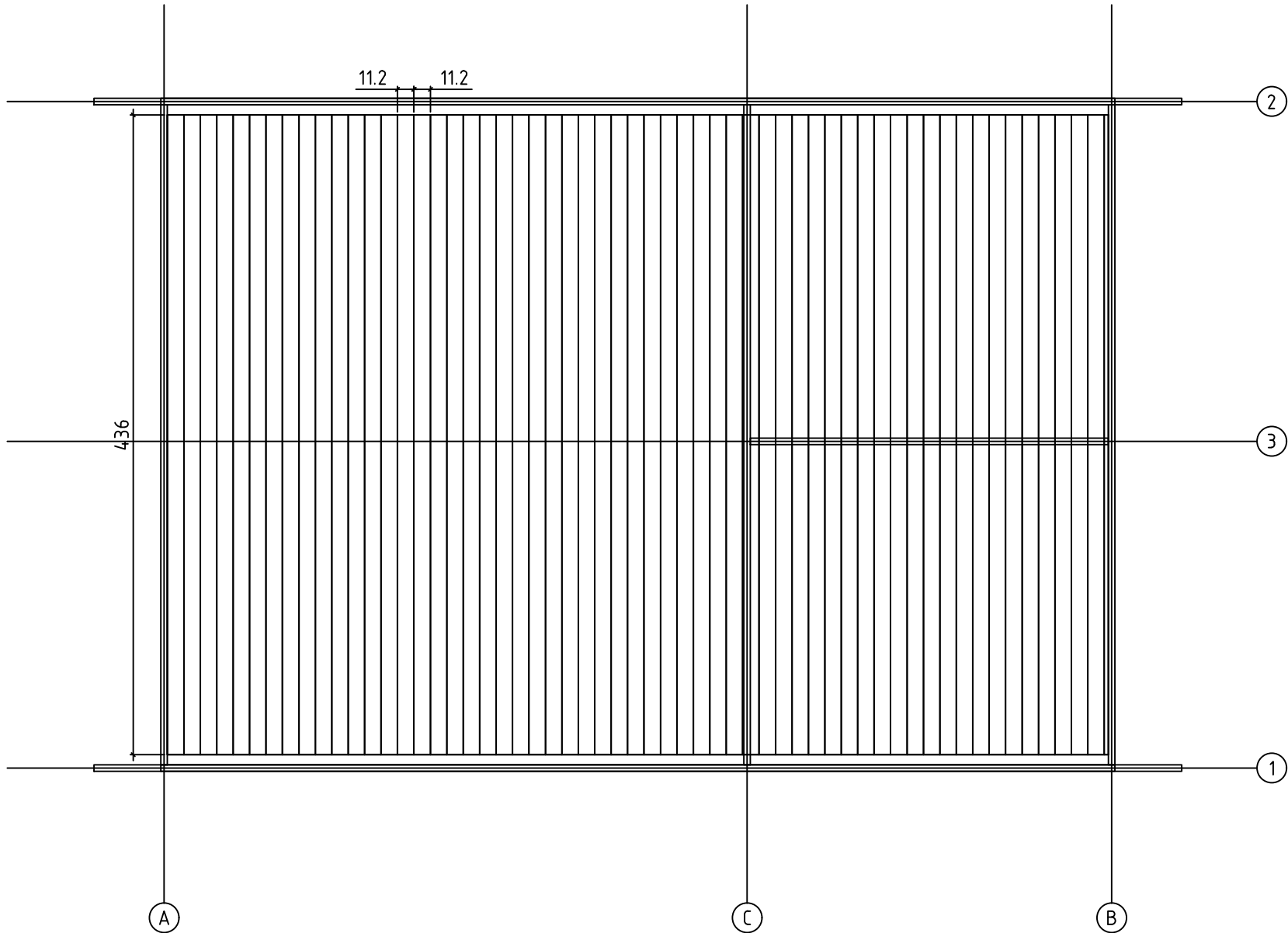





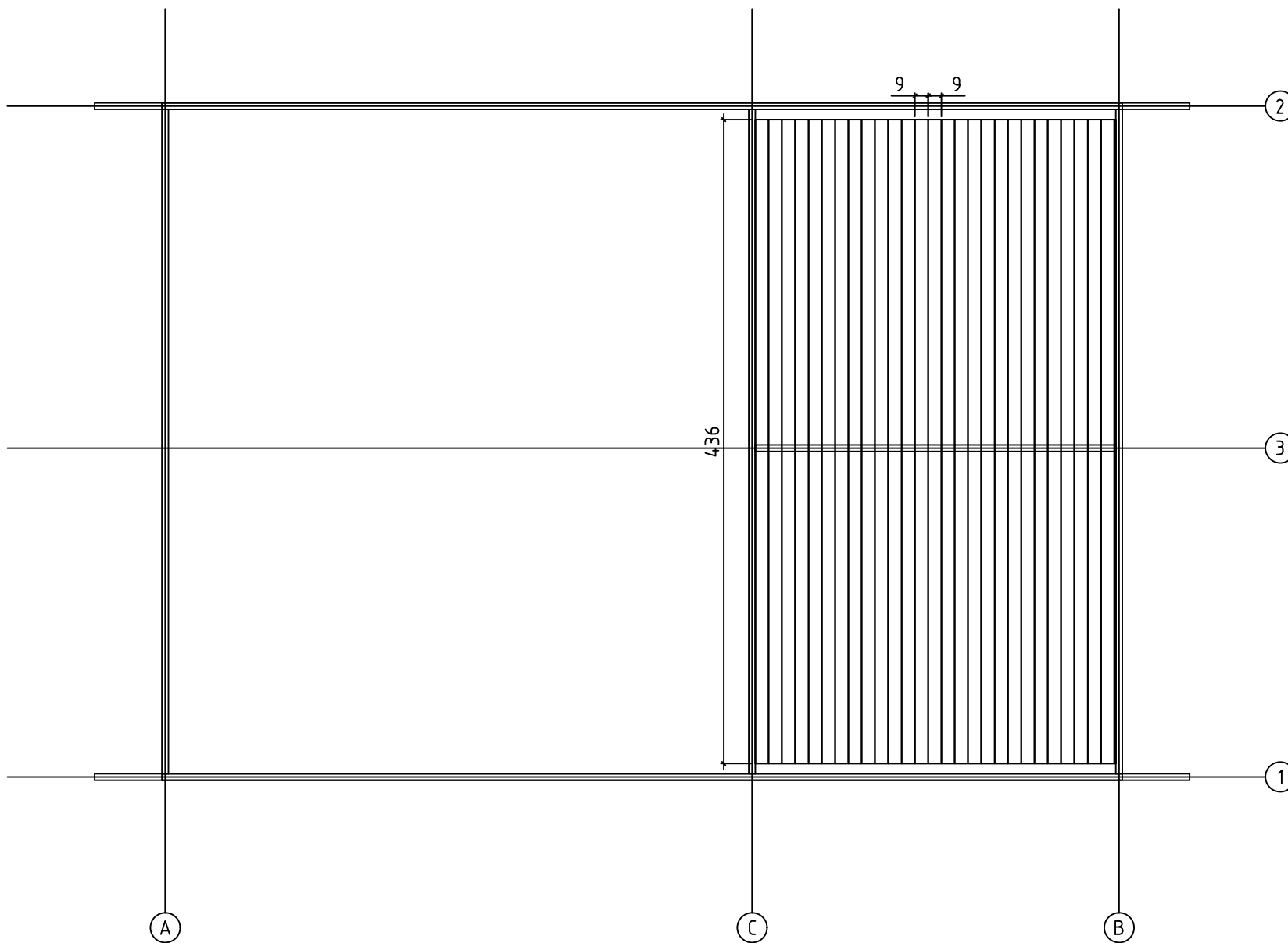

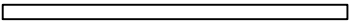
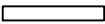
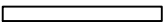
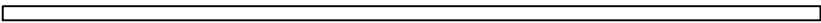
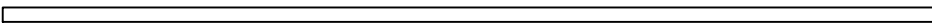

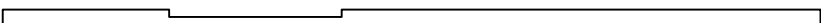
Floorboards





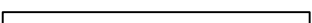
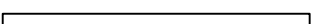
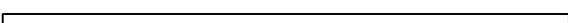
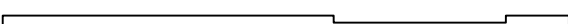
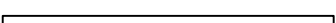
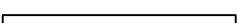

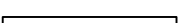



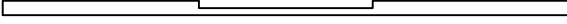
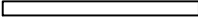
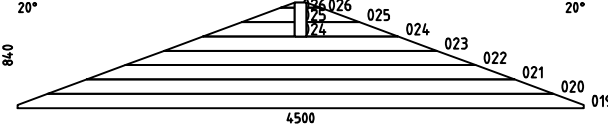
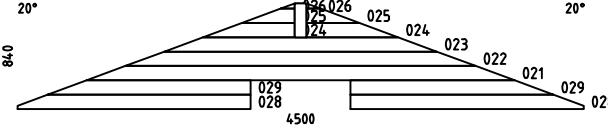
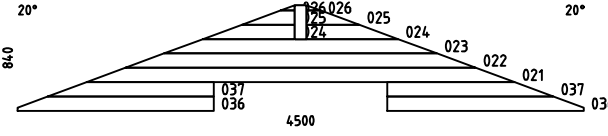
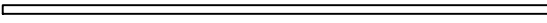
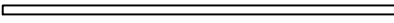



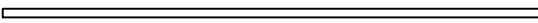
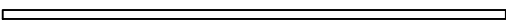
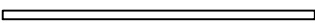
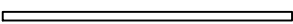

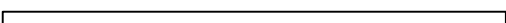

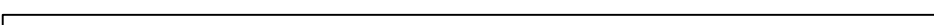







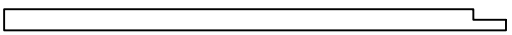
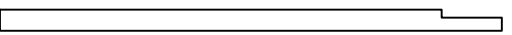

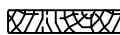
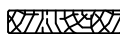
Art. Nr. 4432599

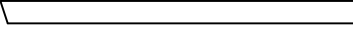
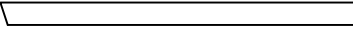
Loft floorboards



Pos	06.05.2024	PIECE LIST Art. Nr. 4432599	17/22	Q.	P (mm)	L (mm)
001				26	44x114	2740
002				18	44x114	805
003				6	44x114	1265
004				15	44x114	6500
005				4	44x114	7412
006				4	44x114	456
007				22	44x114	555
008				1	44x114	6500
009				9	44x114	1323
010				3	44x114	3807
011				6	44x114	2177
012				15	44x114	500
013				1	44x86	2440
014				18	44x114	2440
015				1	44x114	2440
016				38	44x114	4500
017				1	44x114	4500
018				9	44x114	2630
027				8	44x114	1853
030				2	44x86	650
031				1	44x86	1380
032				34	44x114	650
033				17	44x114	1380

Pos	06.05.2024	PIECE LIST Art. Nr. 4432599	18/22	Q.	P (mm)	L (mm)
034				1	44x114	4500
035				8	44x114	1560
WA-1				1		
WB-1				1		
WC-1				1		
PT1		FLOOR FILLET		4	70x70	4360
PT2		FLOOR FILLET		6	70x70	3136
VT1		MEZZANINE FLOOR JOISTS		2	70x45	4360
VT2		MEZZANINE FLOOR JOISTS		9	44x146	2440
IAR2		FOUNDATION		14	120x18	3240
IAR1		FOUNDATION		8	90x18	3240
AR2		FOUNDATION		4	45x70	4298
AR5		FOUNDATION		13	45x70	4000
AR3		FOUNDATION		6	45x70	2480
AR7		FOUNDATION		7	45x70	2300
AR1		FOUNDATION		4	44x146	4568
AR4		FOUNDATION		13	44x146	4000
AR6		FOUNDATION		13	44x146	2304
SR1		RAFTER		30	44x170	2900
A-PR1		ROOF BEAM		1	90x270	7412

Pos	06.05.2024	PIECE LIST Art. Nr. 4432599	19/22	Q.	P (mm)	L (mm)
HLL-1	FLOOR BOARDS		58	112x28	4360	
FB-1	FLOOR BOARDS		28	90x18.5	4360	
RB-1	ROOF BOARDS		66	90x18.5	5093	
RB-2	ROOF BOARDS		66	90x18.5	2319	
RFF	ROOFING FELT FILLET		4	18x58	3050	
RS1	RAILING STRIP		4	18x120	2850	
RS2	RAILING STRIP		4	18x120	2850	
P1	POST		2	70x70	2061	
P2	POST		8	70x70	2700	
TB1	EAVES BOARD		4	18x90	3517	
TB2	EAVES BOARD		4	18x90	3895	
UT-1	U-PROFILE		2	35x70	740	
UT-2	U-PROFILE		1	35x70	1400	
GL1	GABLE MOULDING		8	18x120	3050	
GL2	GABLE MOULDING		4	18x140	3050	
	LADDER		1			
HS8	SCREW		400	3.5x35		
HS9	SCREW		250	3.5x50		
HSx	SCREW		500	3.9x70		
HS13	SCREW		40	4x60		
HS18	SCREW		60	5x120		
HS16	SCREW		1000	5x90		
HS23	SCREW		250	6x180		

Art. Nr. 4432599

U.3TV.b 900x1990

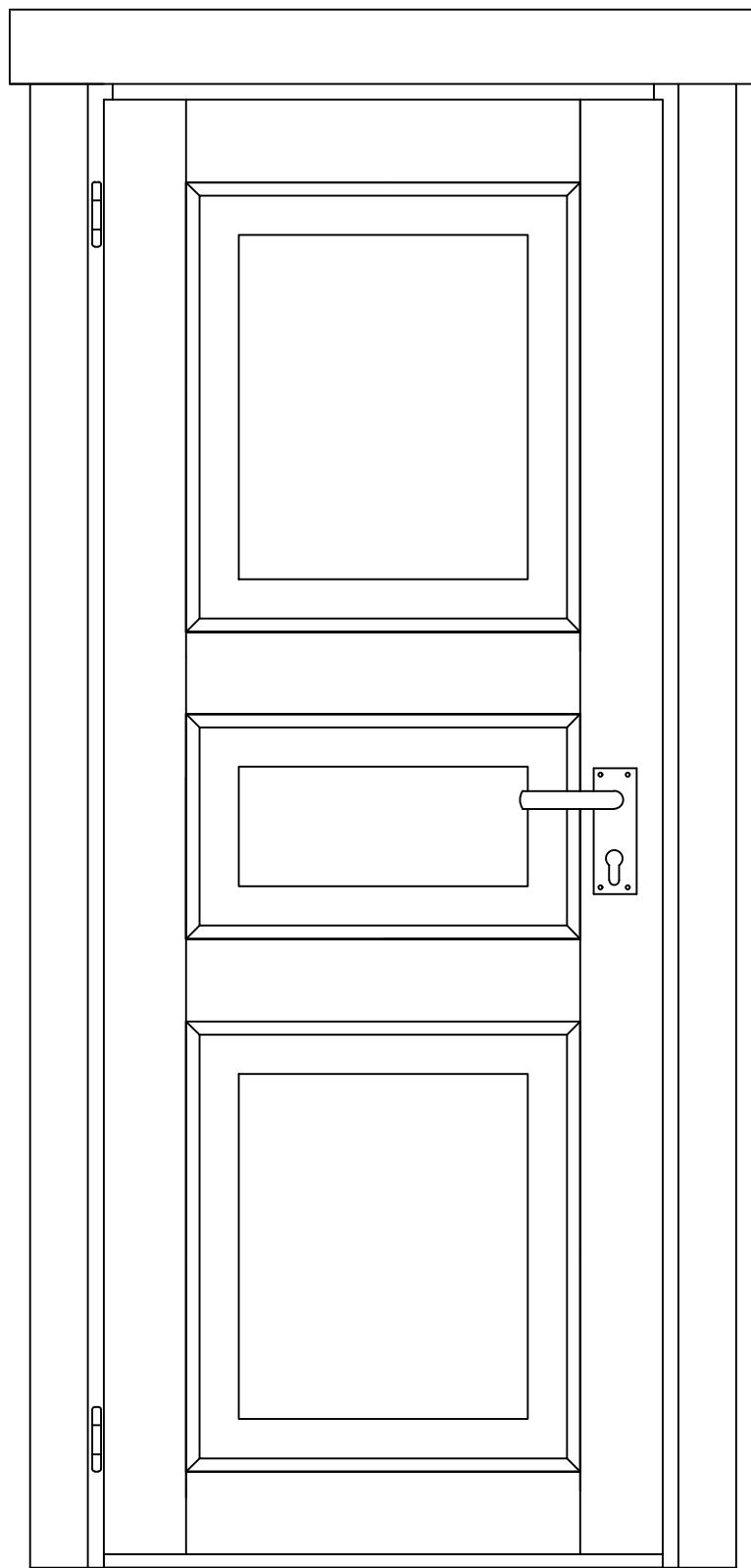

Art. Nr. 4432599

U.3TP.b 900x1990

