

Art. Nr. 4432799

1/22

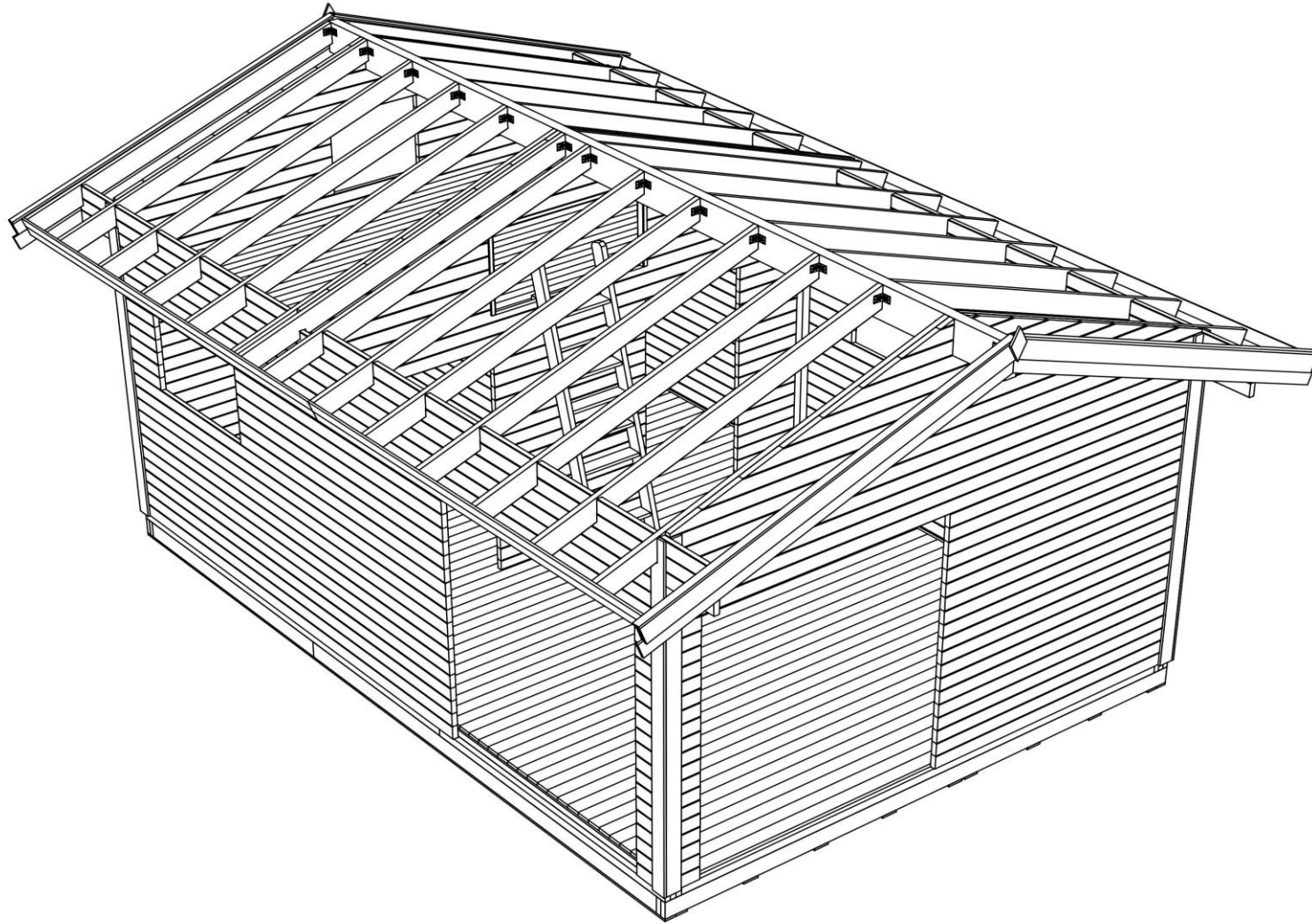

24.05.2024

Art. Nr. 4432799

Groundplan version 1

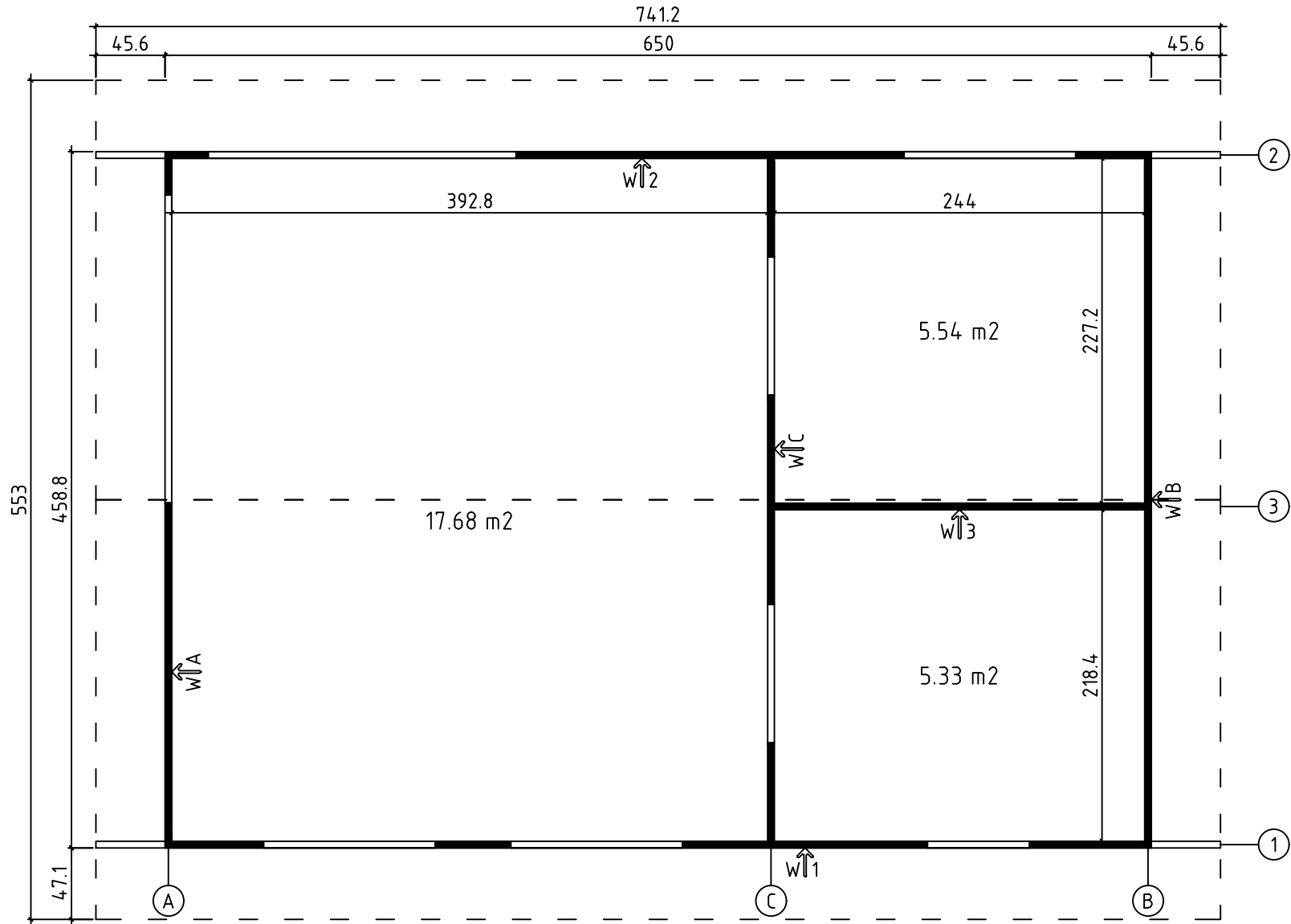

Art. Nr. 4432799

Groundplan version 2

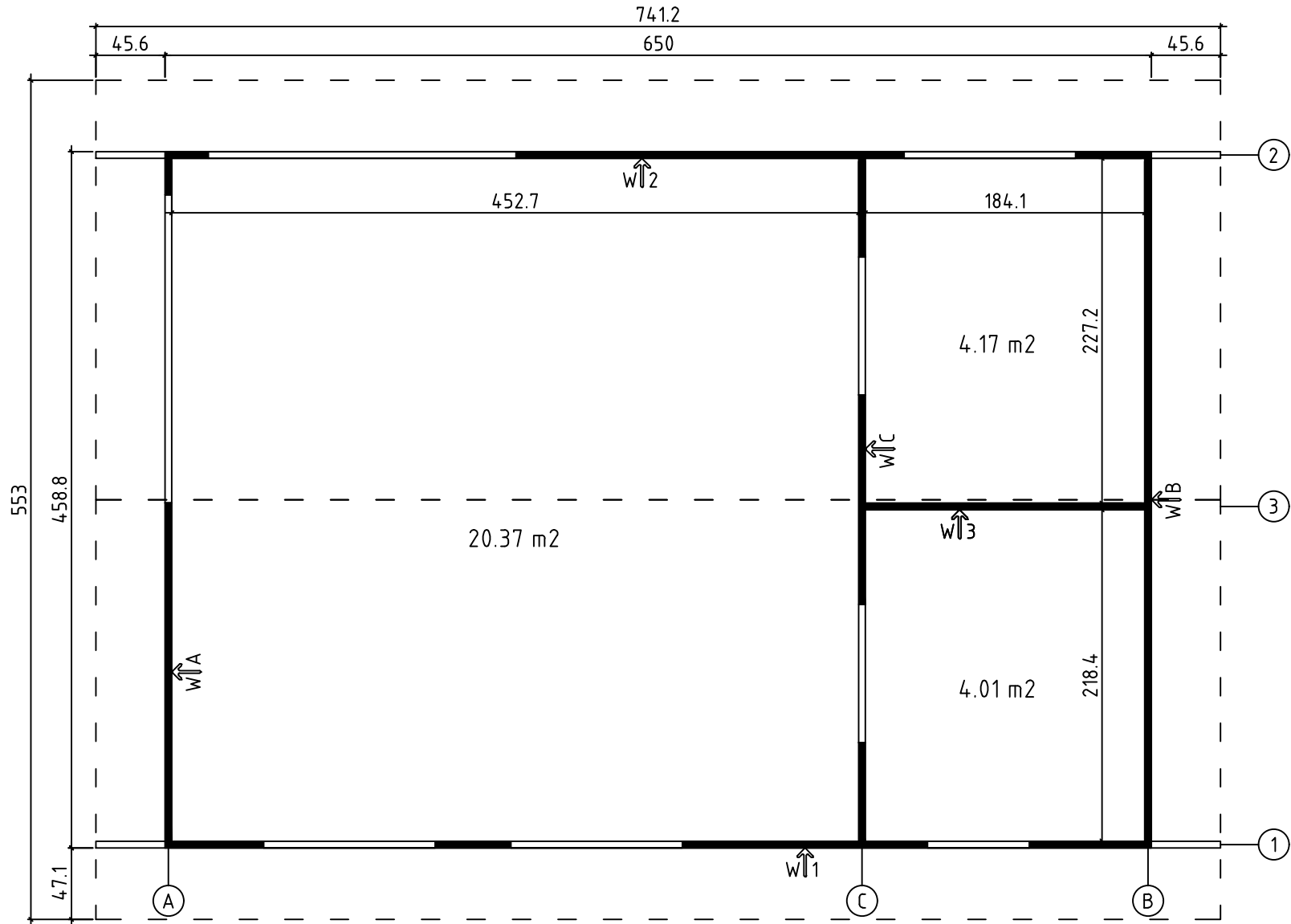

Art. Nr. 4432799

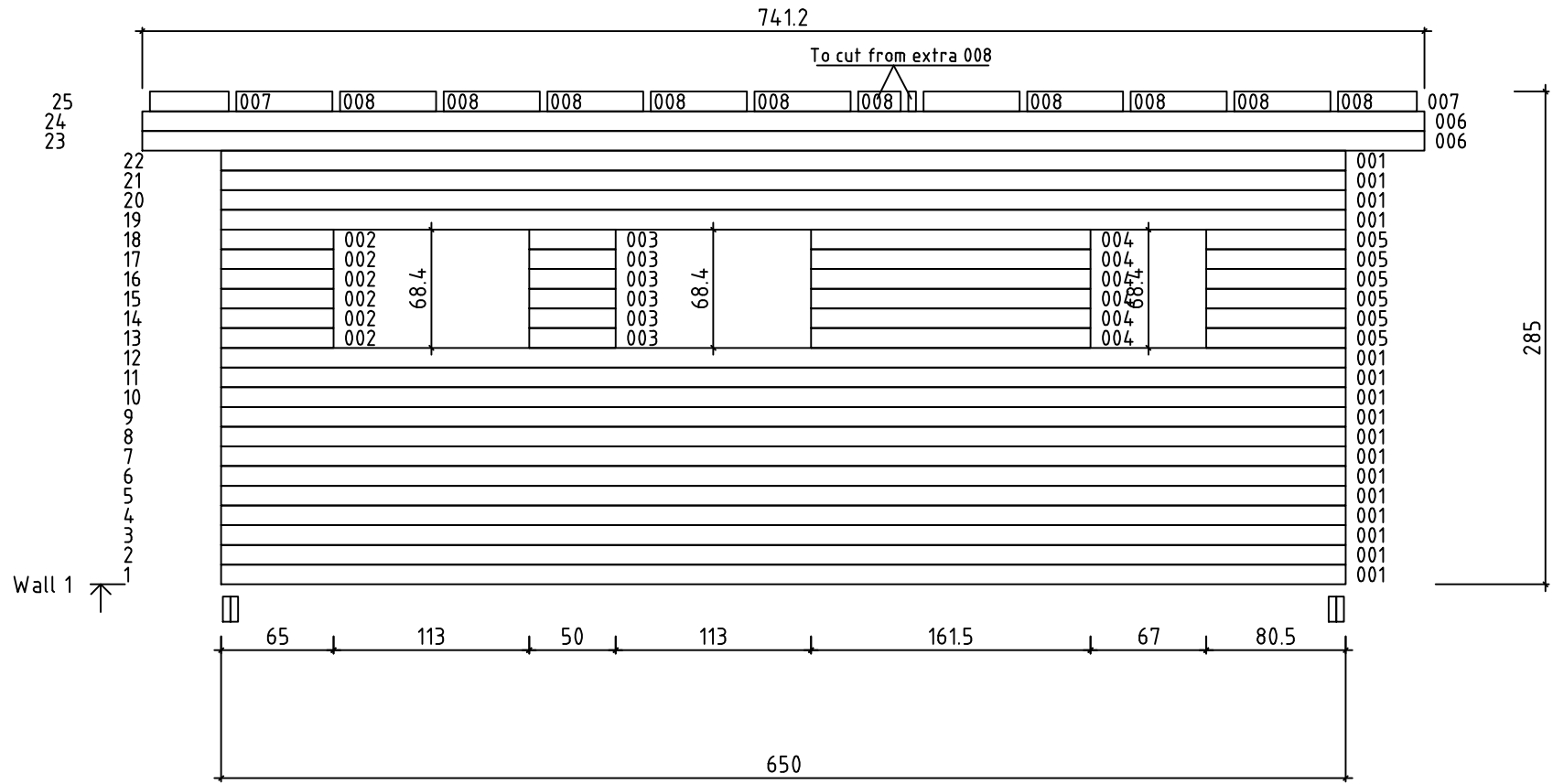

Art. Nr. 4432799

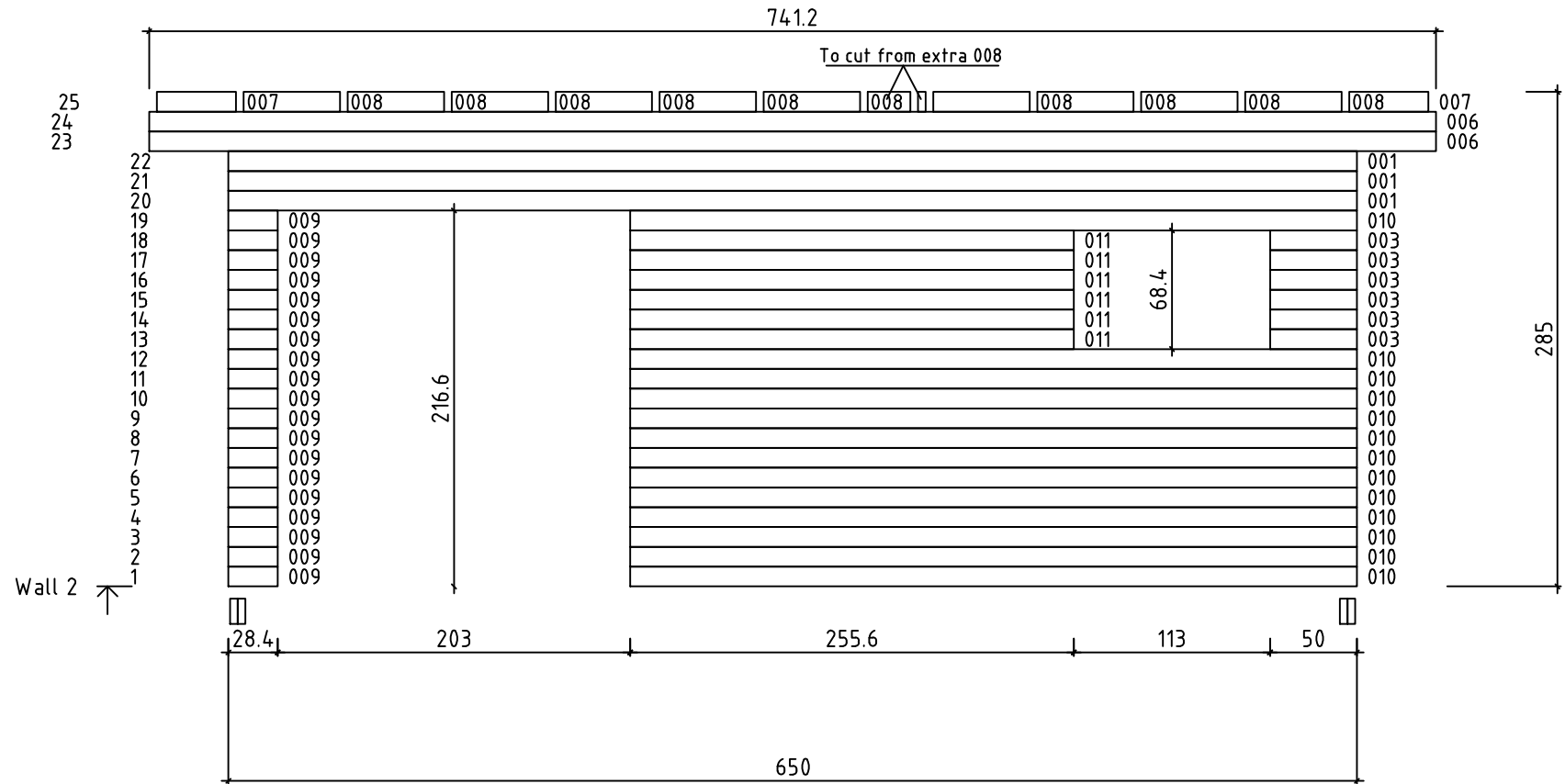

Art. Nr. 4432799

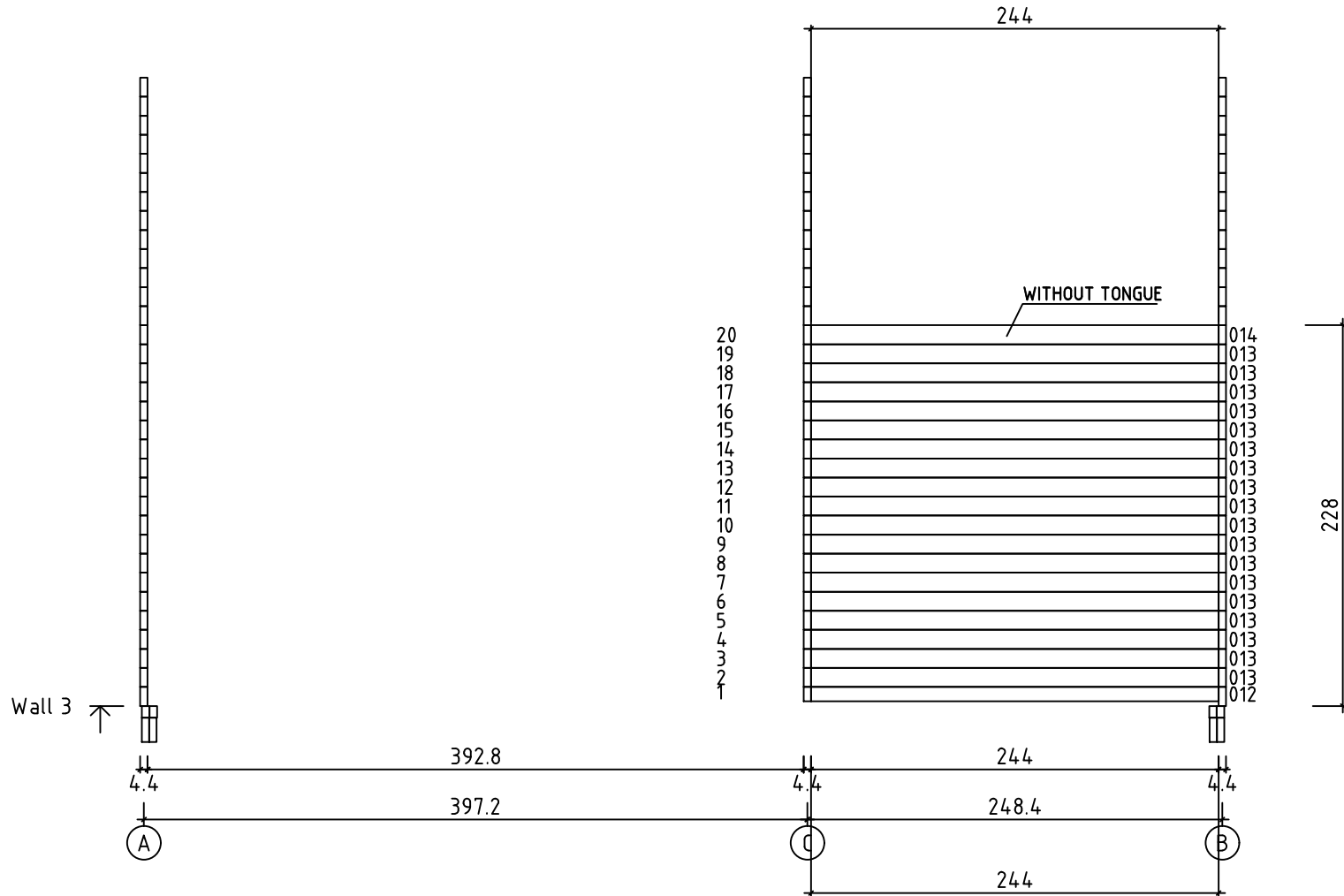

Art. Nr. 4432799

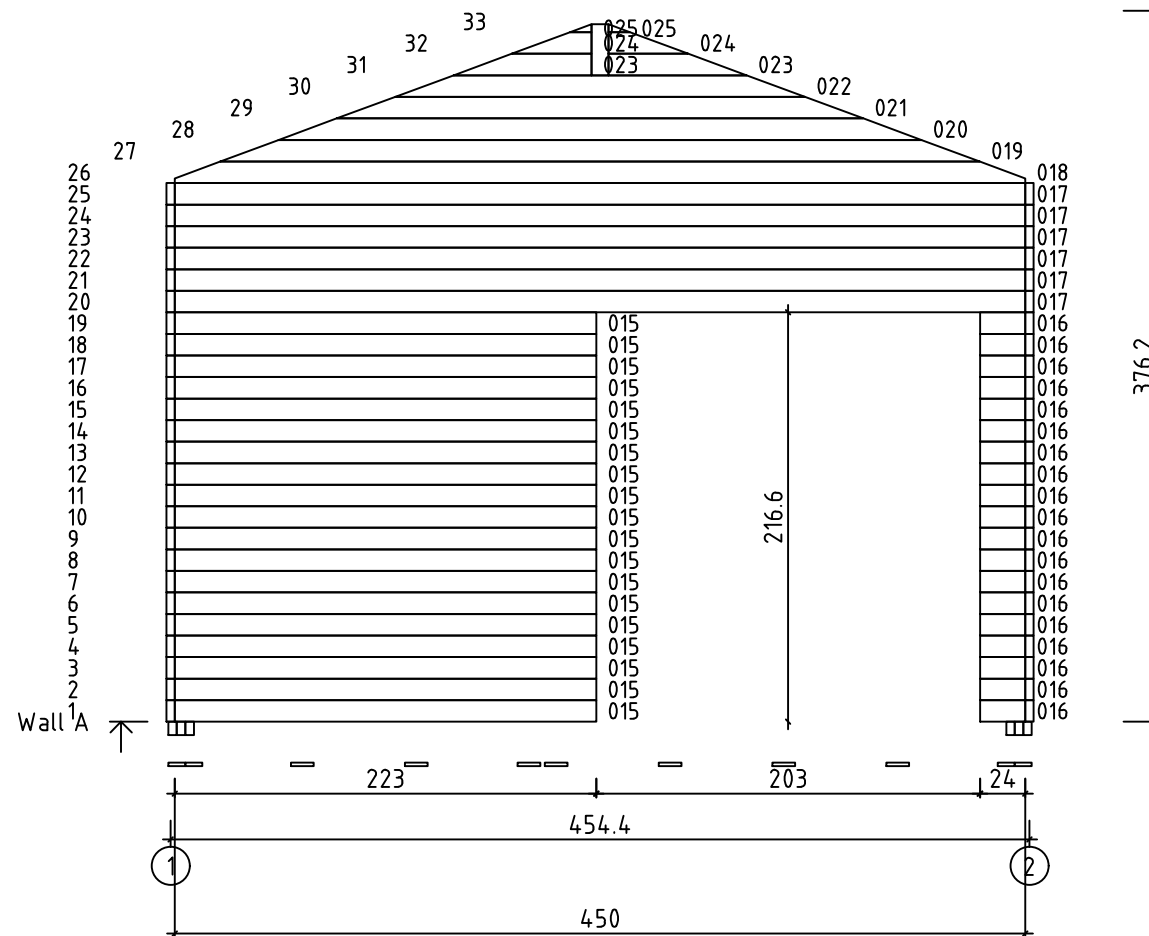

Art. Nr. 4432799

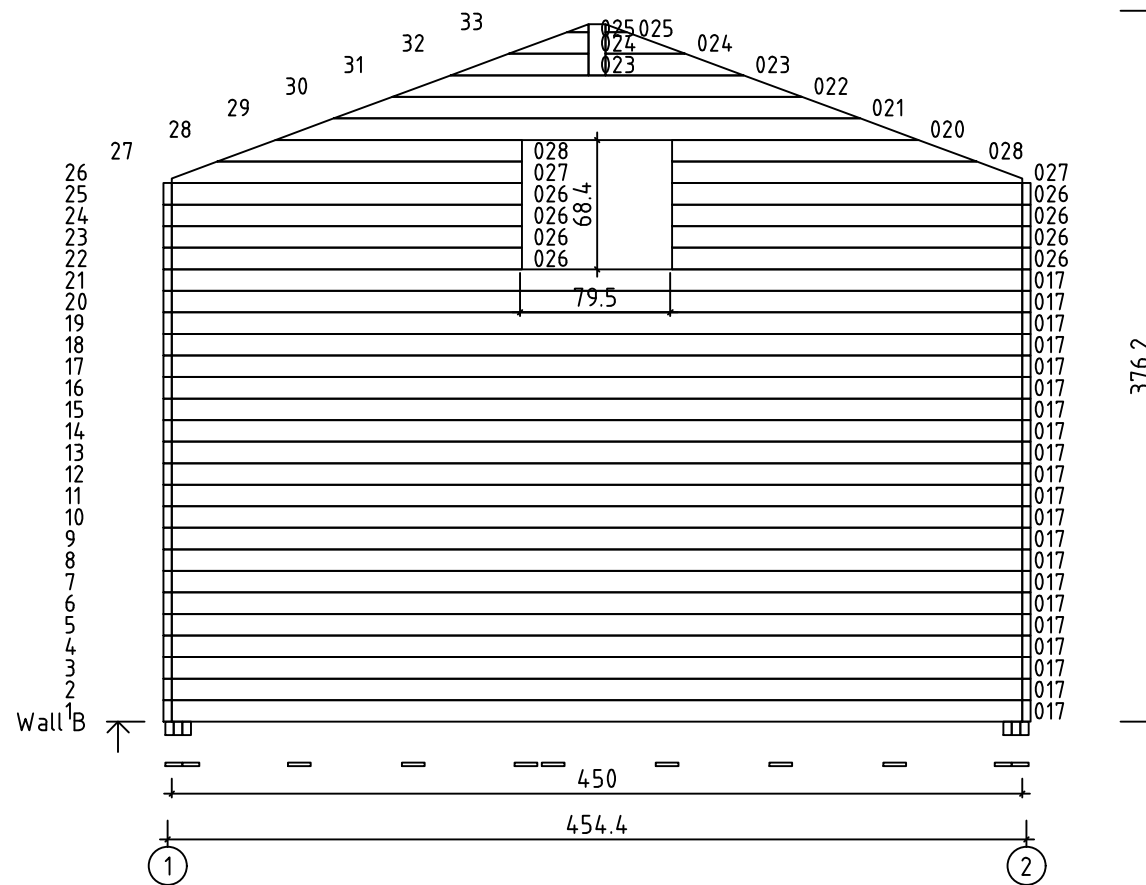

Art. Nr. 4432799

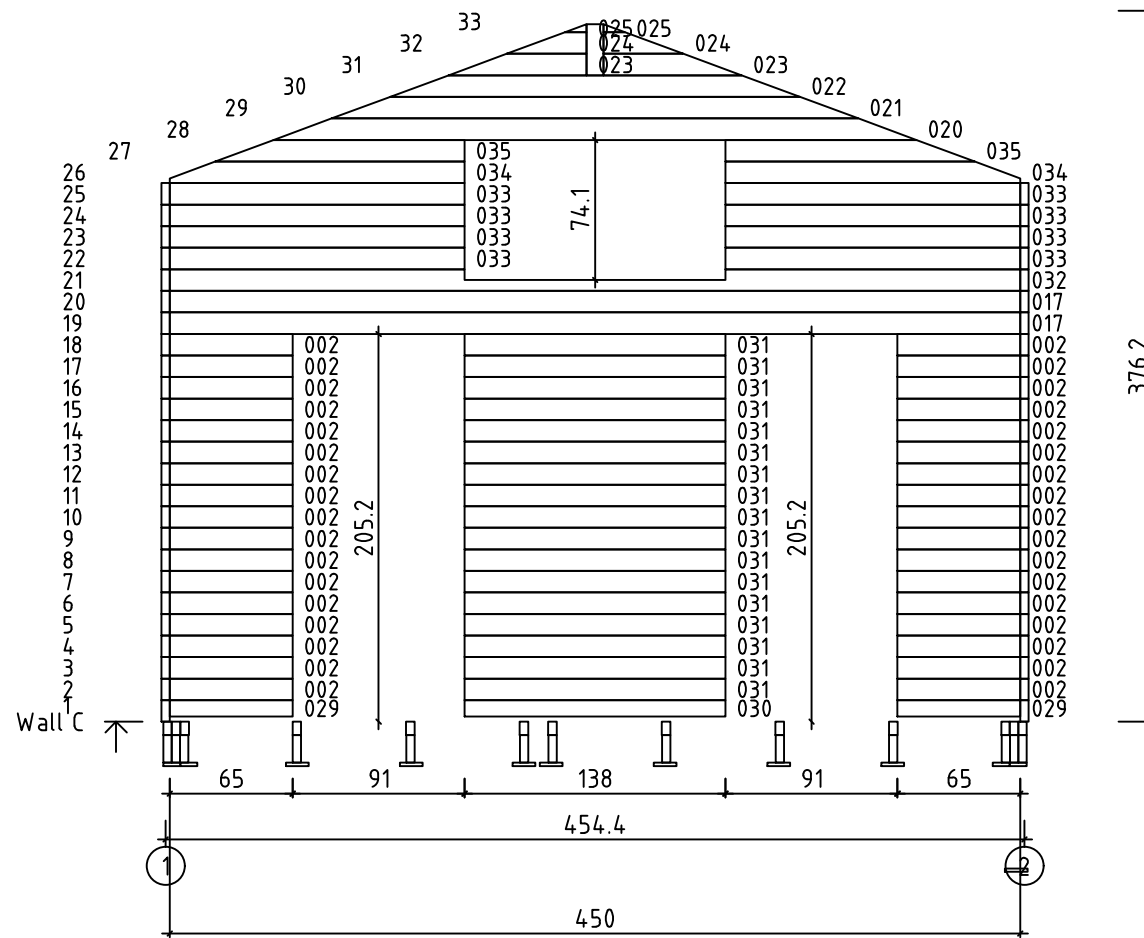

Art. Nr. 4432799

Impregnated foundation boards

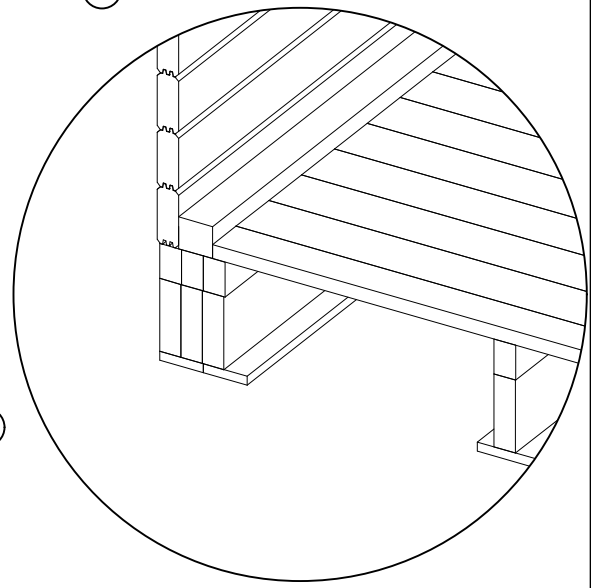
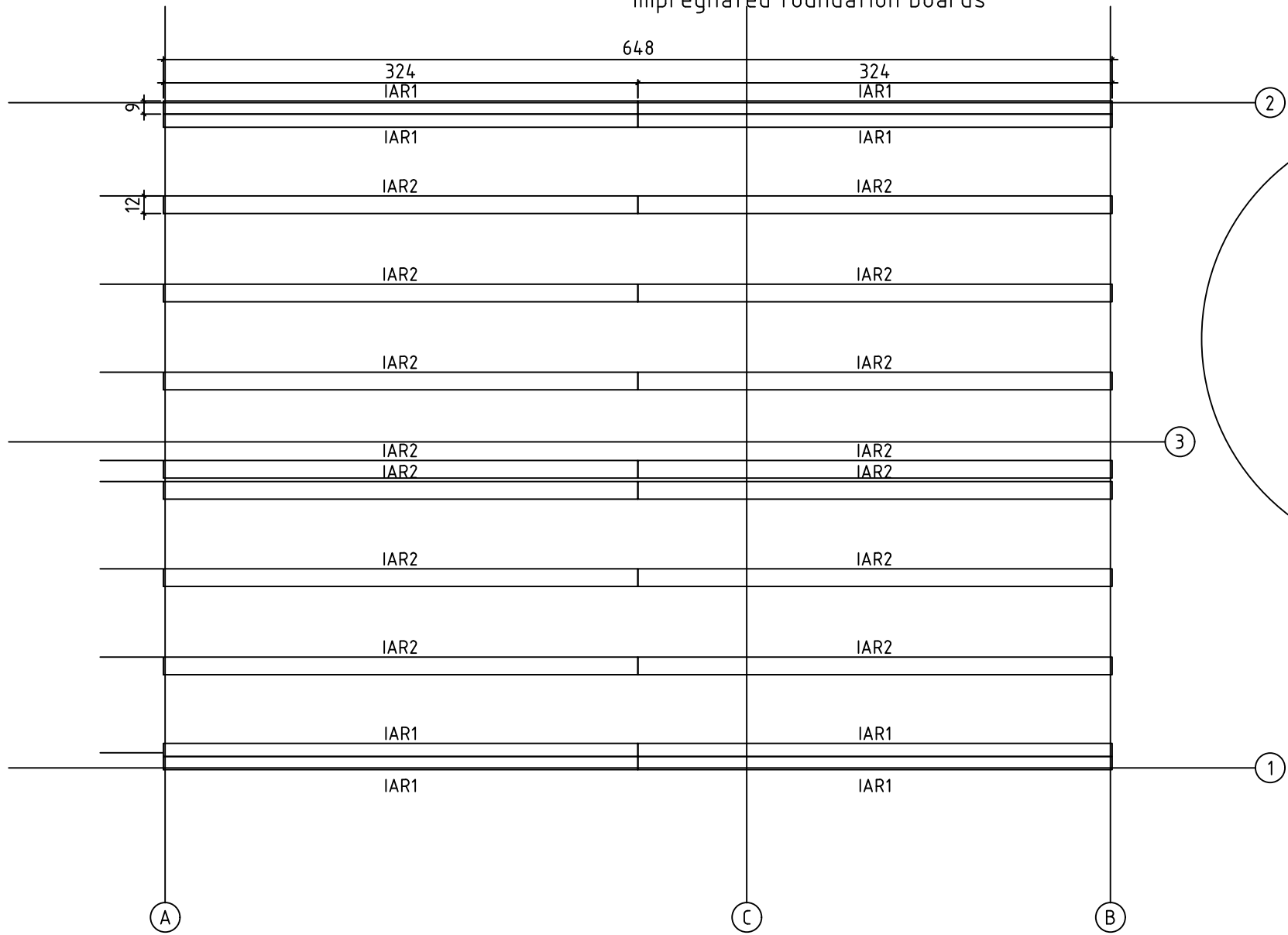

Art. Nr. 4432799

44x146 floor joists

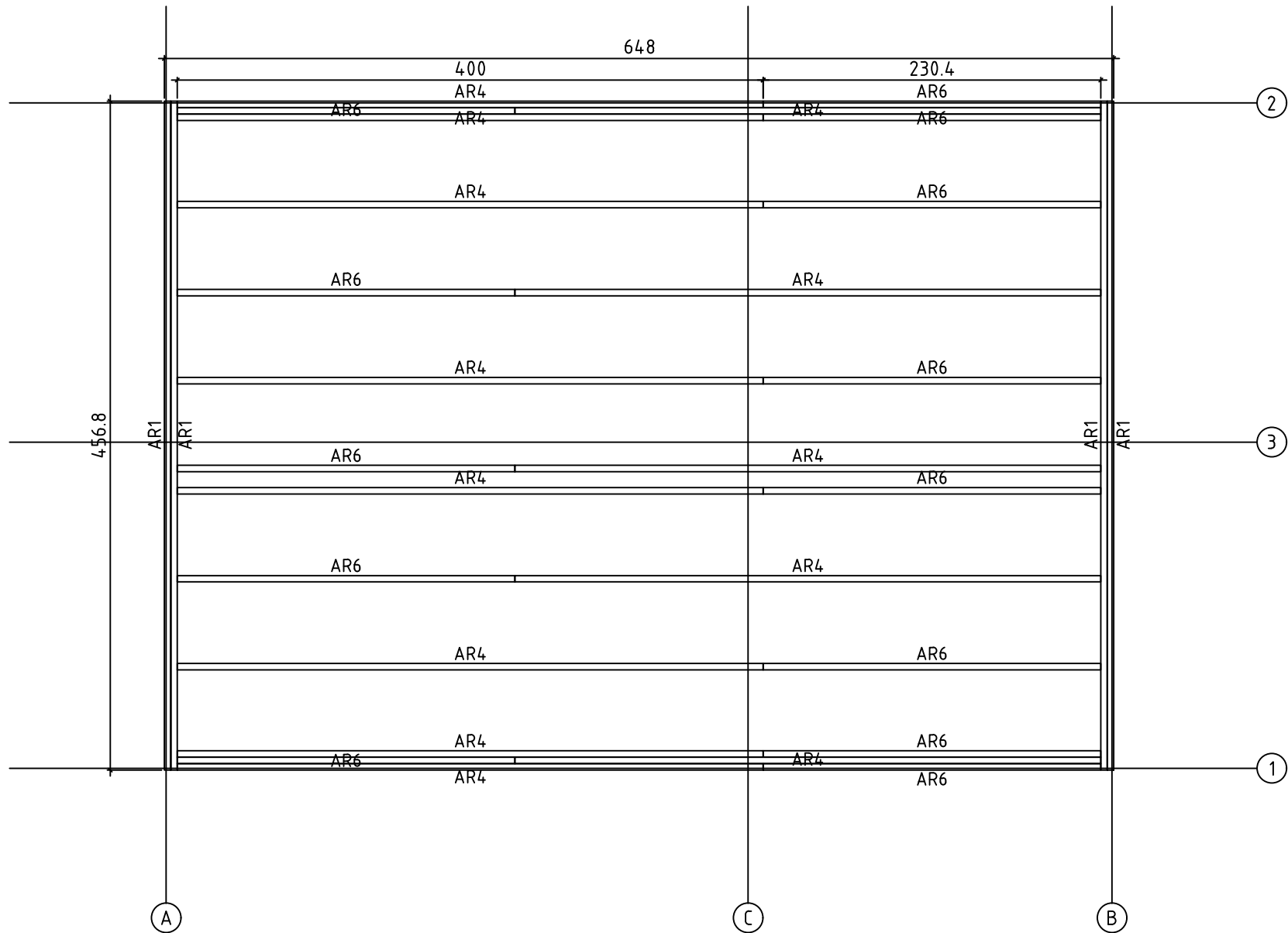

Art. Nr. 4432799

45x70 floor joists

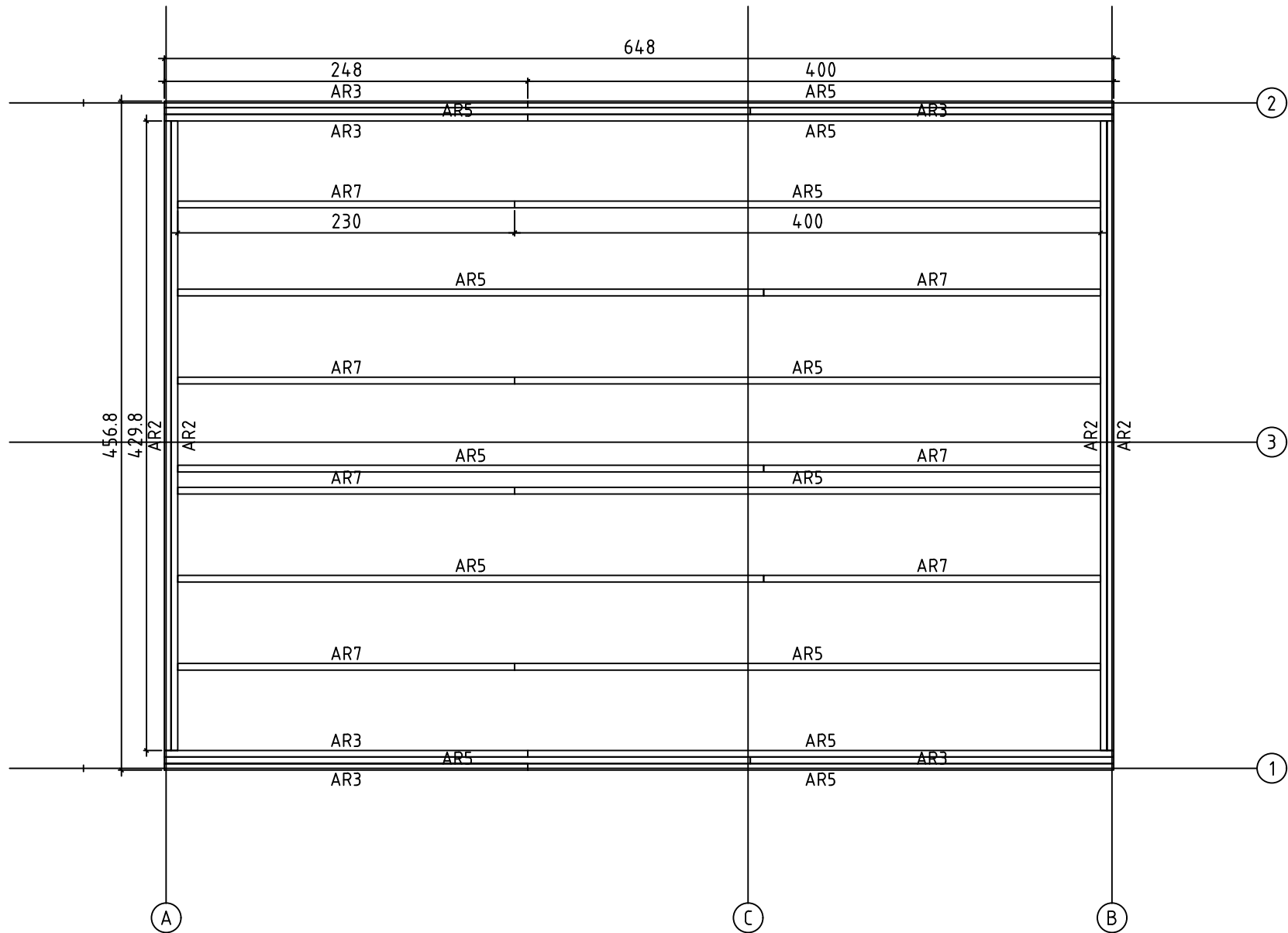

Art. Nr. 4432799

Rafters

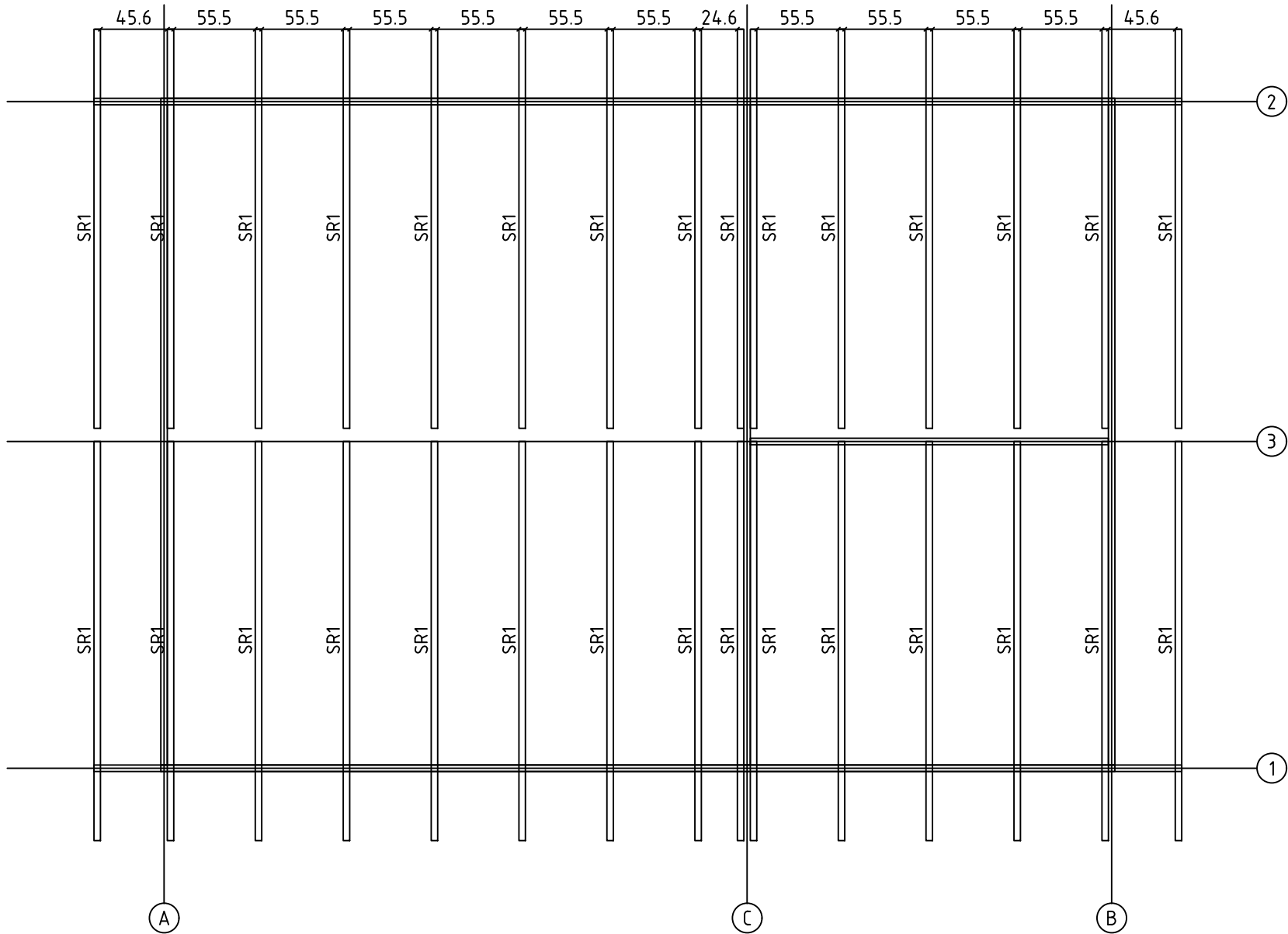

24.05.2024

13/22

Art. Nr. 4432799

Loft beams

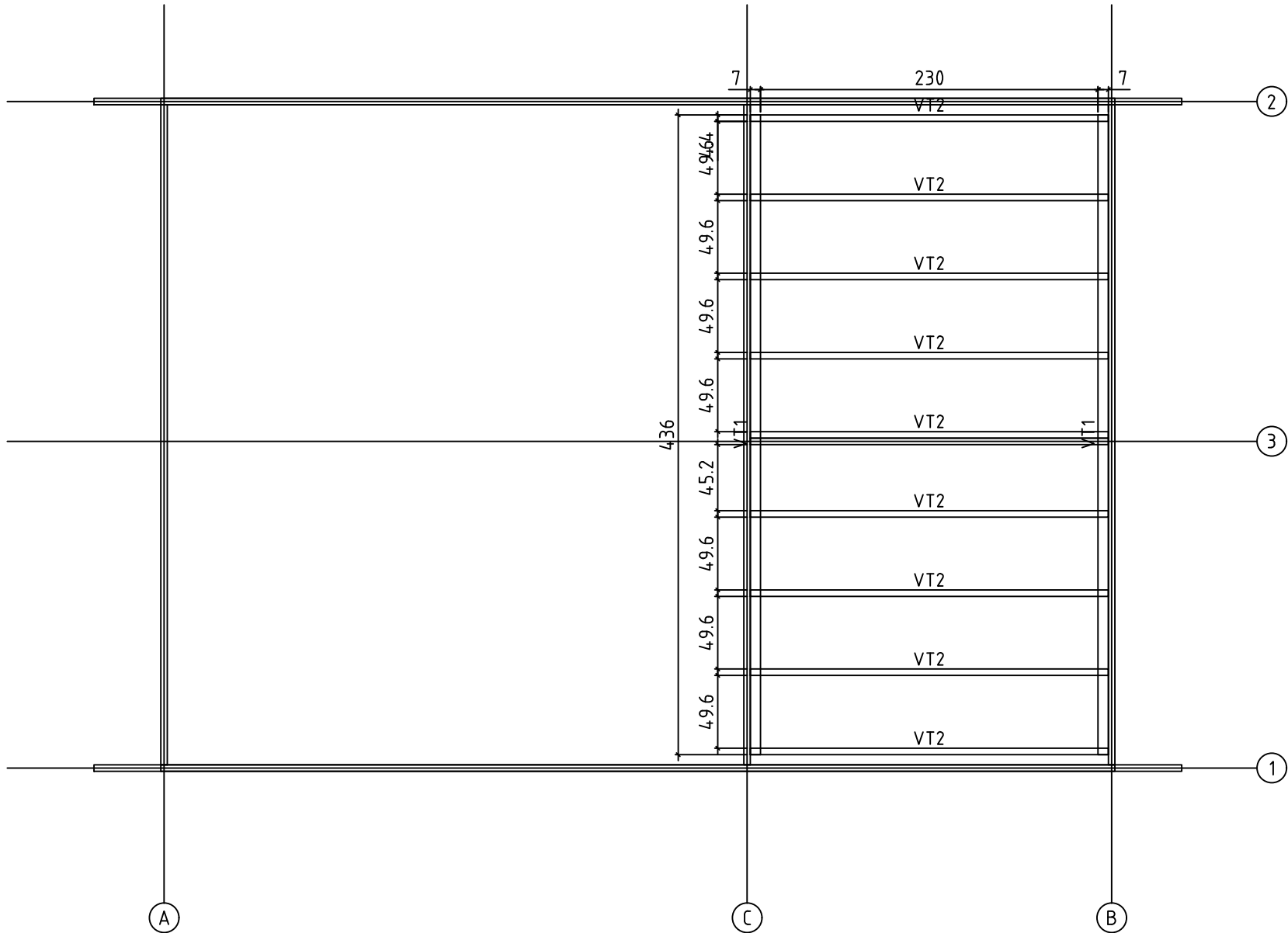

Art. Nr. 4432799



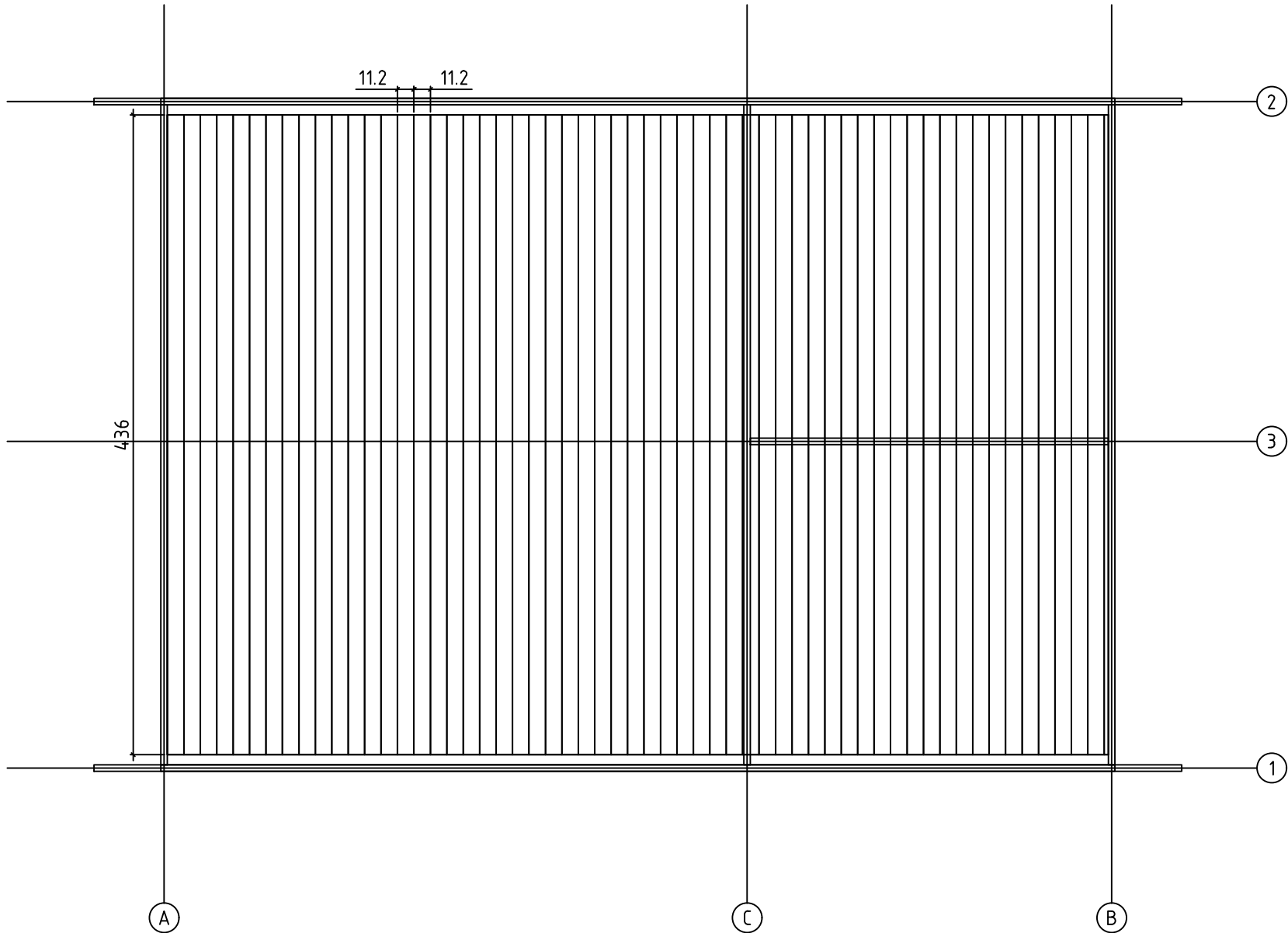





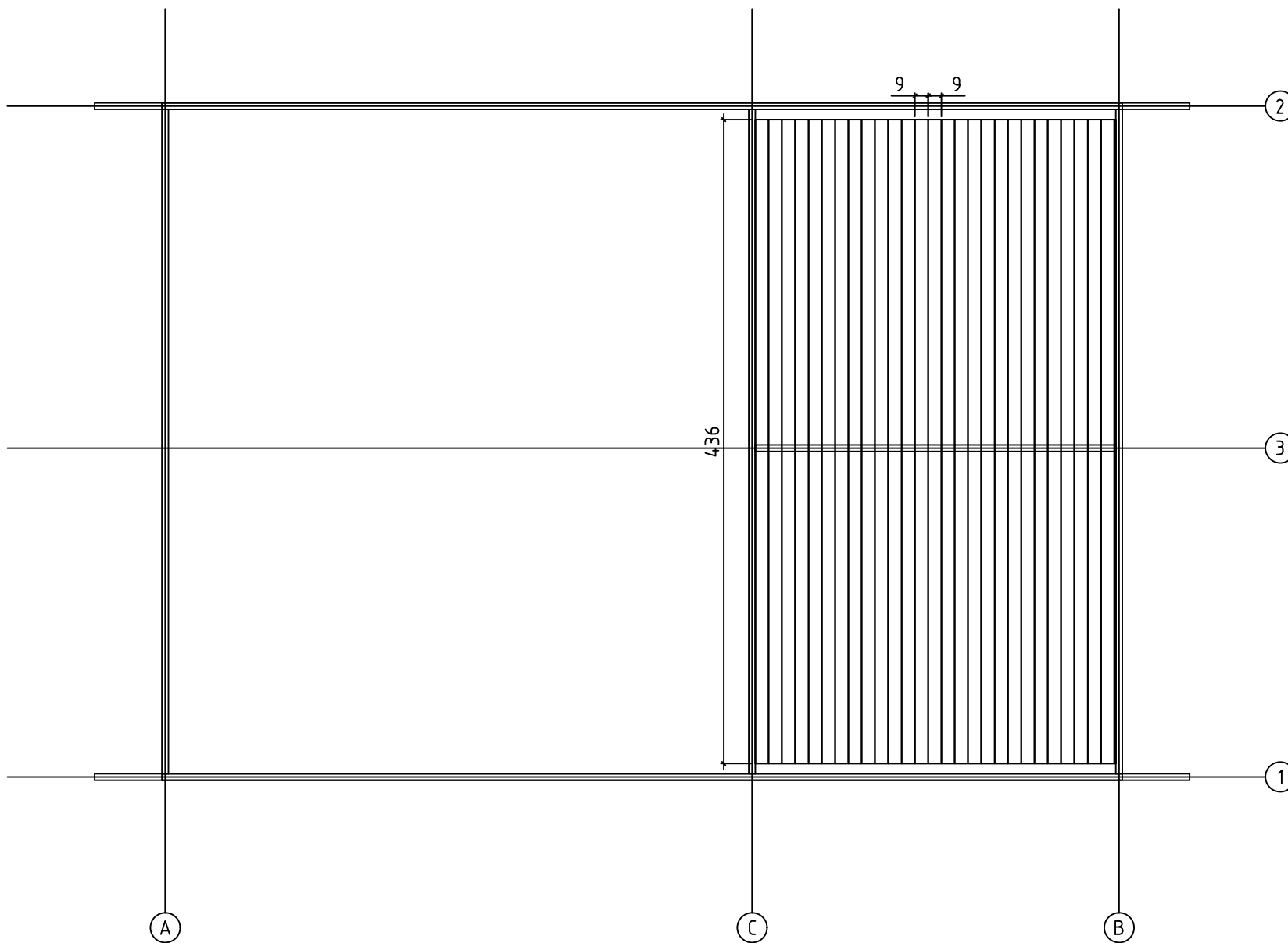

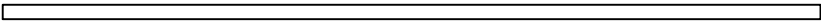

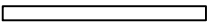
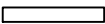



Floorboards



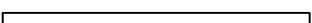
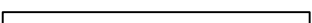
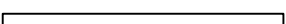

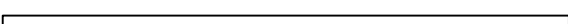
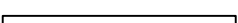

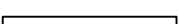
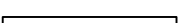







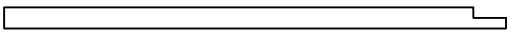
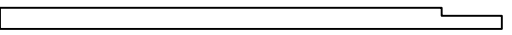

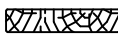
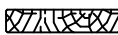

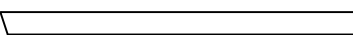
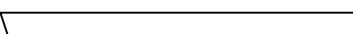
Art. Nr. 4432799

Loft floorboards



Pos	24.05.2024	PIECE LIST Art. Nr. 4432799	17/22	Q.	P (mm)	L (mm)
001				20	44x114	6500
002				40	44x114	650
003				12	44x114	500
004				6	44x114	1615
005				6	44x114	805
006				4	44x114	7412
007				4	44x114	456
008				22	44x114	555
009				19	44x114	284
010				13	44x114	4186
011				6	44x114	2556
012				1	44x86	2440
013				18	44x114	2440
014				1	44x114	2440
015				19	44x114	2230
016				19	44x114	240
017				29	44x114	4500
026				8	44x114	1853
029				2	44x86	650
030				1	44x86	1380
031				17	44x114	1380
032				1	44x114	4500
033				8	44x114	1560

Pos	24.05.2024	PIECE LIST Art. Nr. 4432799	18/22	Q.	P (mm)	L (mm)
WA-1				1		
WB-1				1		
WC-1				1		
PT1	<p style="text-align: center;">FLOOR FILLET</p>			4	70x70	4360
PT2				6	70x70	3136
VT1	<p style="text-align: center;">MEZZANINE FLOOR JOISTS</p>			2	70x45	4360
VT2	<p style="text-align: center;">MEZZANINE FLOOR JOISTS</p>			9	44x146	2440
IAR2	<p style="text-align: center;">FOUNDATION</p>			14	120x18	3240
IAR1				8	90x18	3240
AR2				4	45x70	4298
AR5				13	45x70	4000
AR3				6	45x70	2480
AR7				7	45x70	2300
AR1				4	44x146	4568
AR4				13	44x146	4000
AR6				13	44x146	2304
SR1	<p style="text-align: center;">RAFTER</p>			30	44x170	2900
A-PR1	<p style="text-align: center;">ROOF BEAM</p>			1	90x270	7412
HLL-1	FLOOR BOARDS			58	112x28	4360
FB-1	FLOOR BOARDS			28	90x18.5	4360

Pos	24.05.2024	PIECE LIST Art. Nr. 4432799	19/22	Q.	P (mm)	L (mm)
RB-1	ROOF BOARDS			66	90x18.5	5093
RB-2	ROOF BOARDS			66	90x18.5	2319
RFF	ROOFING FELT FILLET			4	18x58	3050
RS1	RAILING STRIP			4	18x120	2850
RS2	RAILING STRIP			4	18x120	2850
P1	POST			2	70x70	2061
P2	POST			8	70x70	2700
TB1	EAVES BOARD			4	18x90	3517
TB2	EAVES BOARD			4	18x90	3895
UT-1	U-PROFILE			2	35x70	740
UT-2	U-PROFILE			1	35x70	1400
GL1	GABLE MOULDING			8	18x120	3050
GL2	GABLE MOULDING			4	18x140	3050
	LADDER			1		
HS8	SCREW			400	3.5x35	
HS9	SCREW			250	3.5x50	
HSx	SCREW			500	3.9x70	
HS13	SCREW			40	4x60	
HS18	SCREW			60	5x120	
HS16	SCREW			1000	5x90	
HS23	SCREW			250	6x180	
HS26	SCREW			400	5x40	
SH44	HAMMER BLOCK			1		

Art. Nr. 4432799

U.3TV.b 900x1990

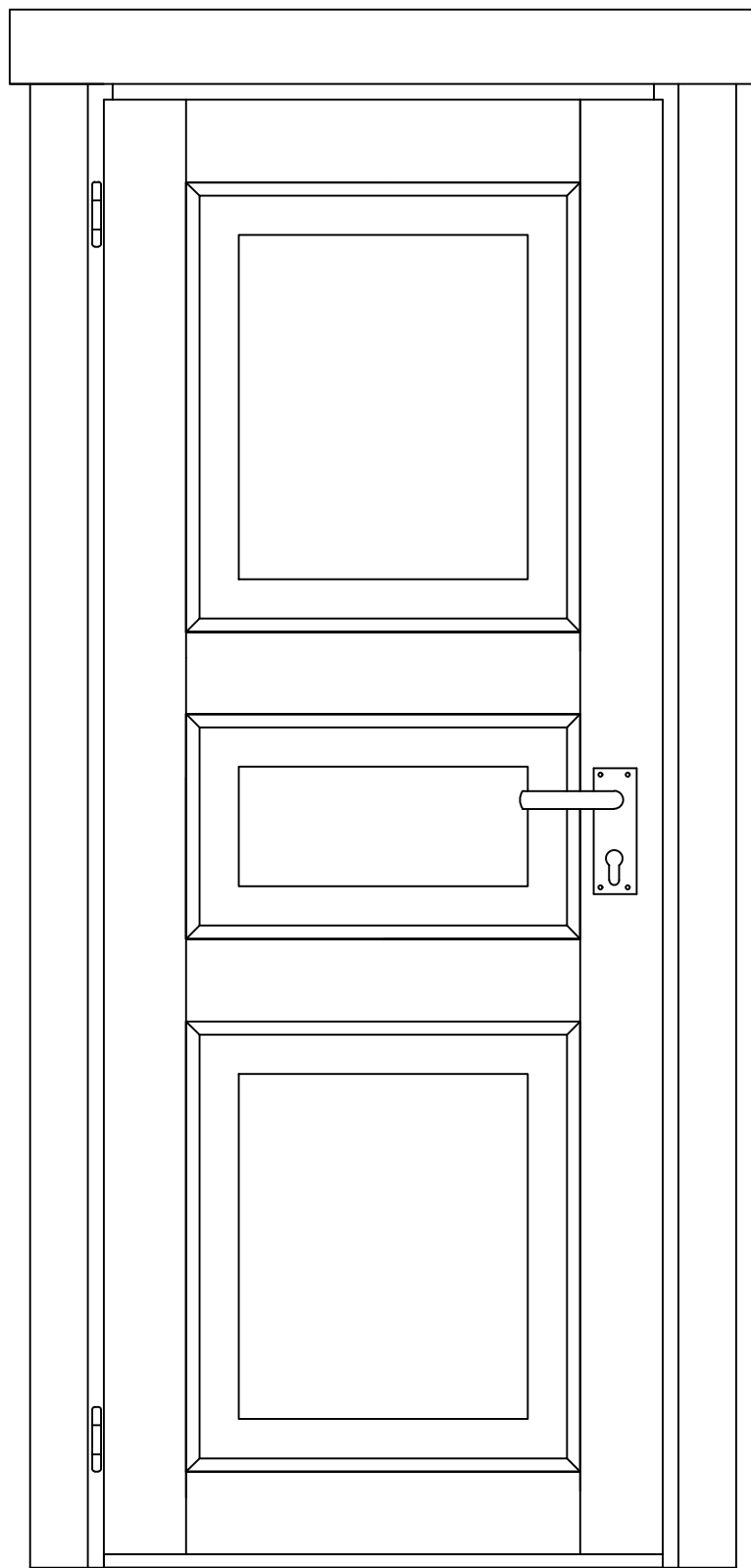

Art. Nr. 4432799

U.3TP.b 900x1990

