

Installation guide

- Package list
- Materials
- Technical drawings

11. September 2023

Elevation A

1:50

+3.870

+2.500

+2.140

+0.000

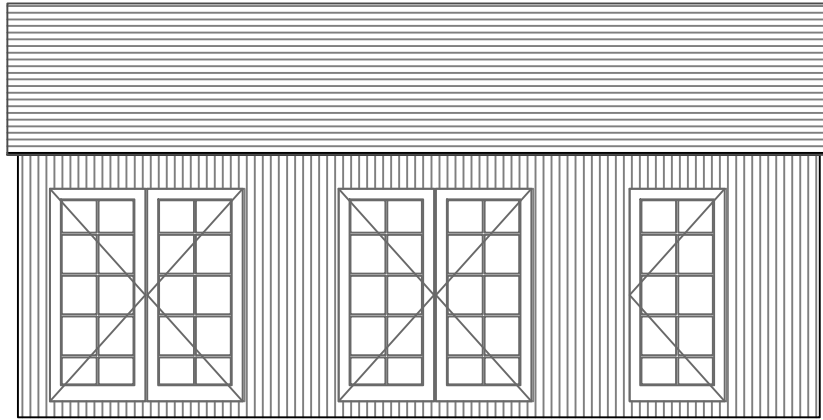

Elevation B

1:50

+3.870

+2.500

+2.140

+0.000

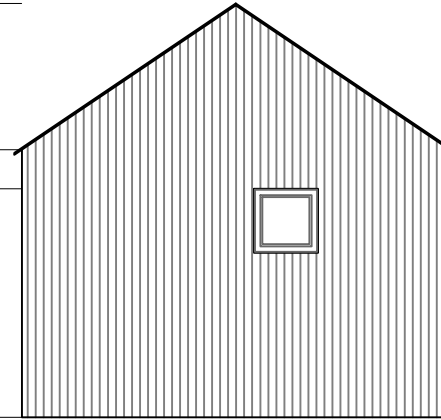

Elevation C

1:50

+3.870

+2.500

+2.140

+0.000

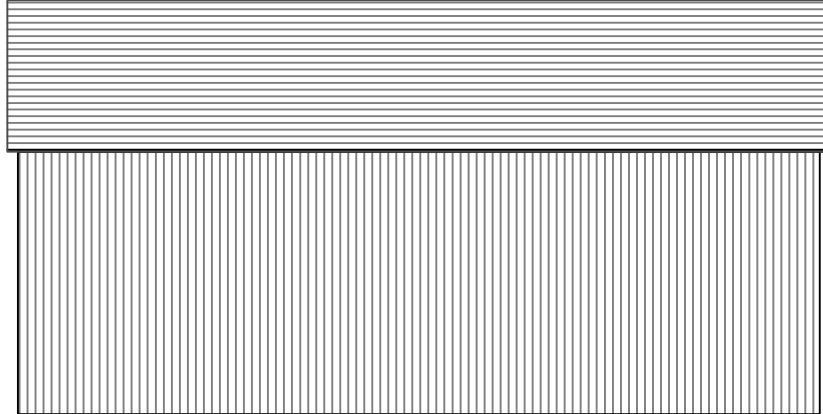

Elevation D

1:50

+3.870

+2.500

+2.140

+0.000

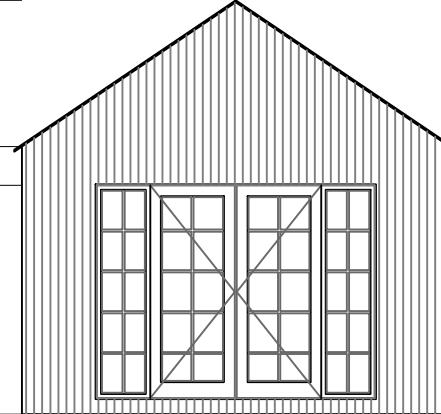

PROJECT	DRAWING		SCALE
MARIEDAL 30 SE 30 m ²			A3 1:50
CLIENT	PROJECT nr.	DATE	DRAWING nr.
	EP	03.08.2023	
	DRAFTED BY	CONTACT	
	Rain-Erik Jøe	56661911	
	ARCHITECT	SIGNATURE	

Plan
1:50

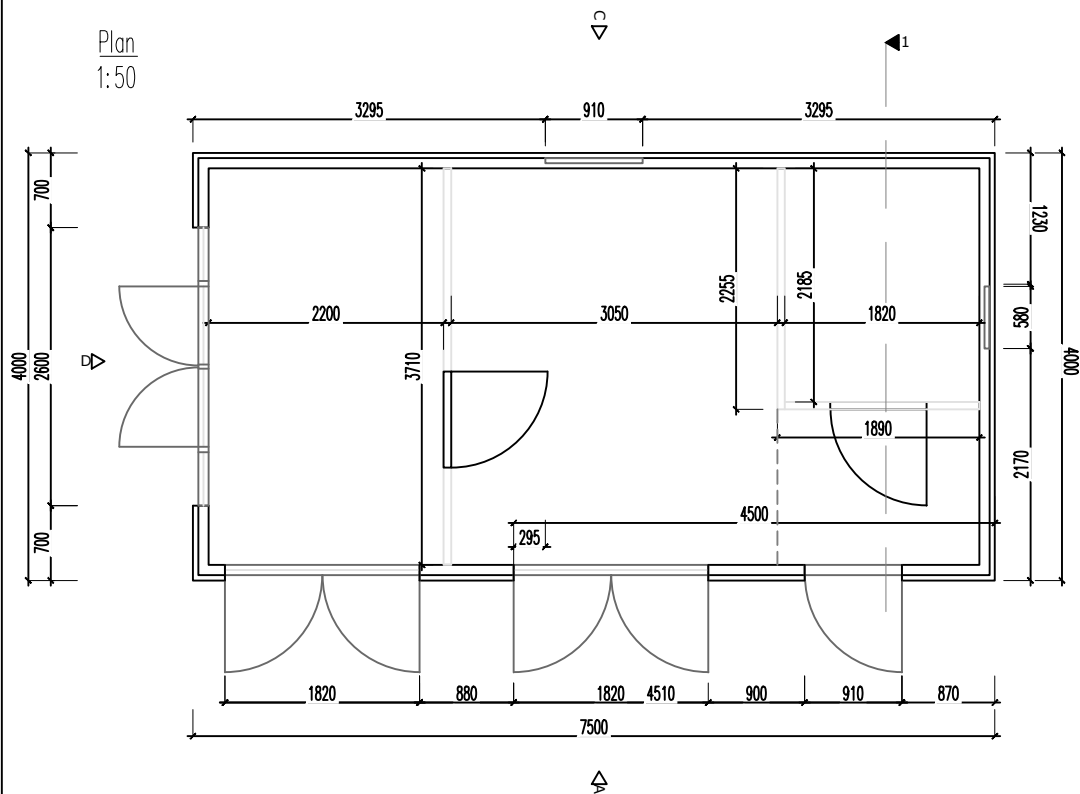

Section 1-1
1:50

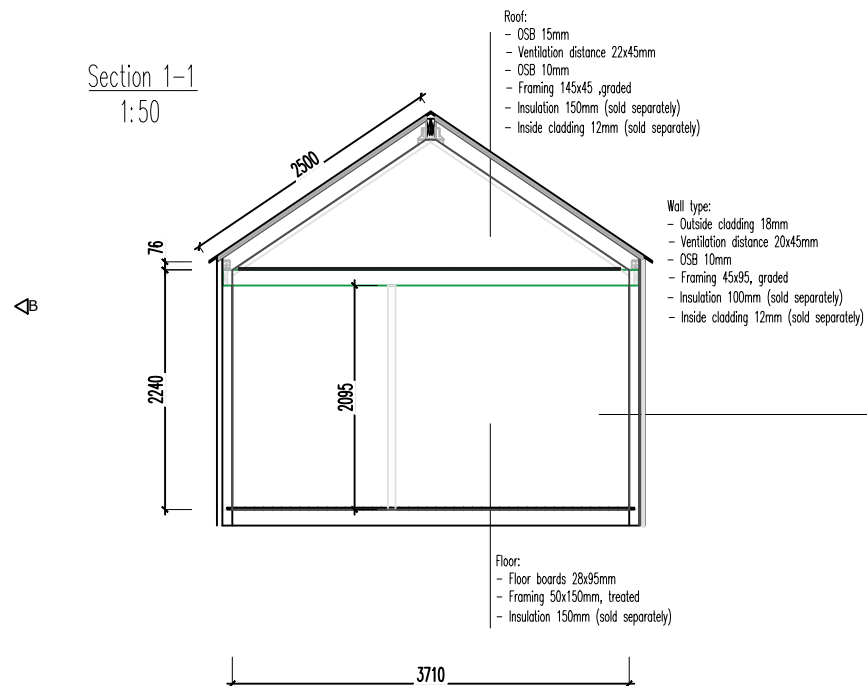

PROJECT	MARIEDAL 30 30 m ²		SCALE	A3 1:50
CLIENT	STATE	EP	DATE	03.08.2023
	DRAFTED BY	Rain-Erik Jøe	CONTACT	56661911
	ARCHITECT		SIGNATURE	

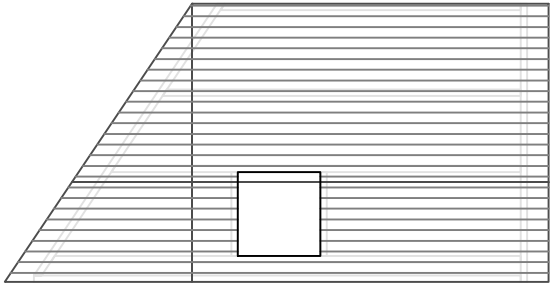
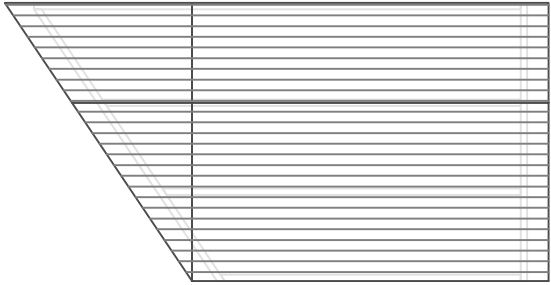
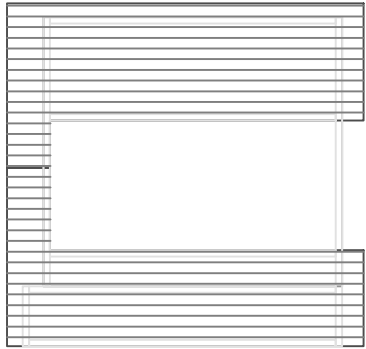
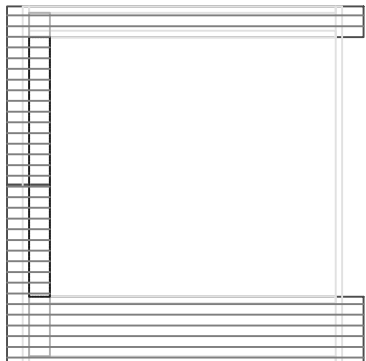
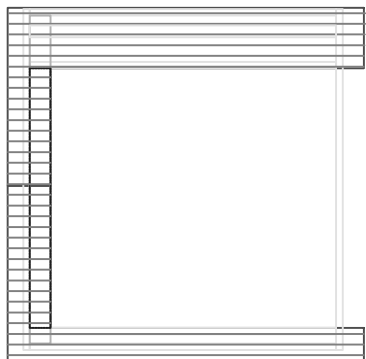

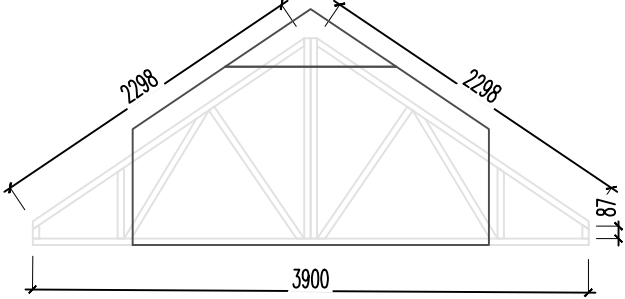
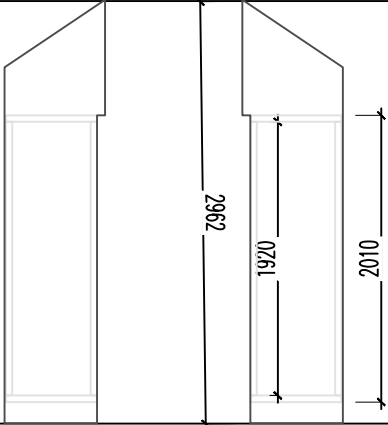
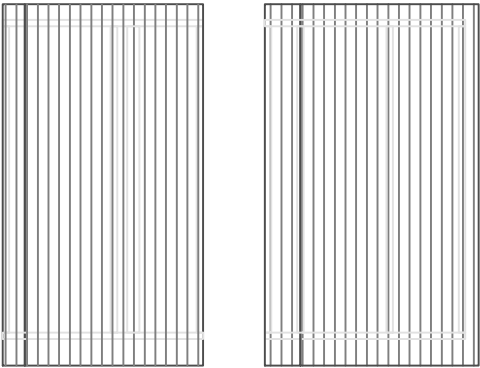
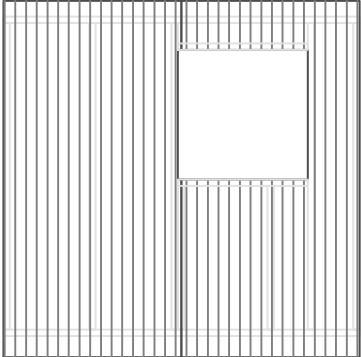
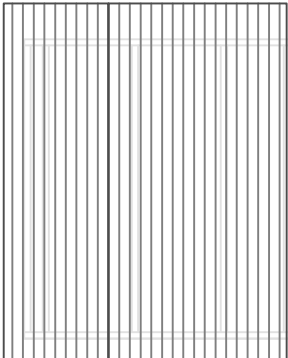

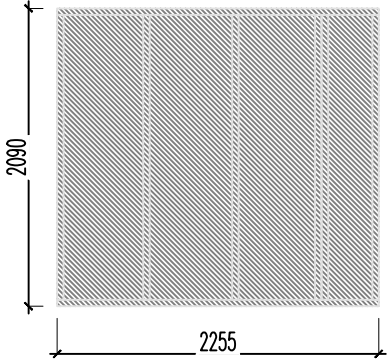
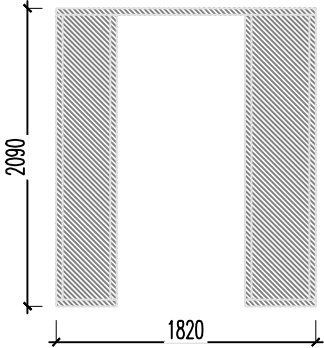
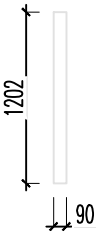
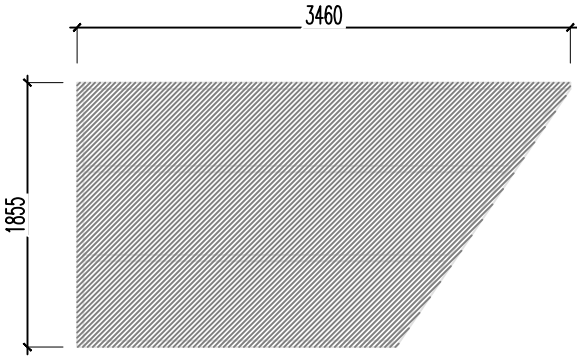
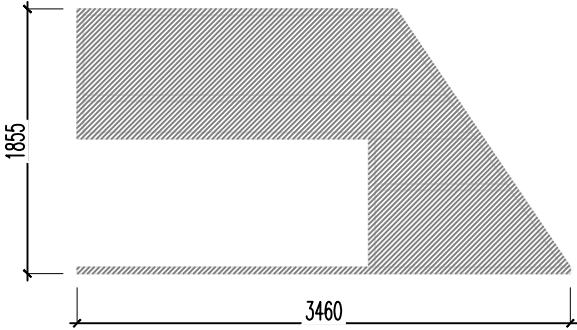
EL 1		1950x3815x143	1 pcs
EL 2		1950x3815x143	1 pcs
EL 3		2500x2500x143	1 pcs
EL 4		2500x2500x143	1 pcs
EL 5		2500x2500x143	1 pcs

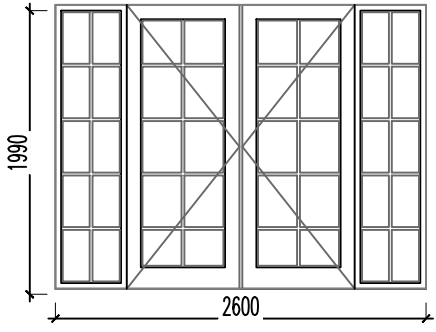
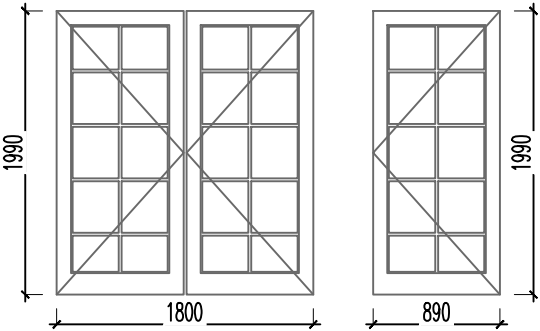
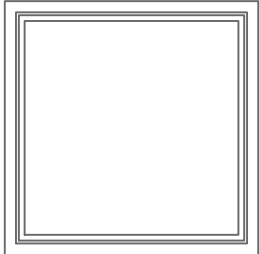
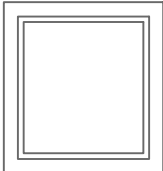
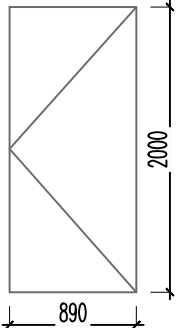

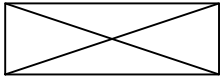
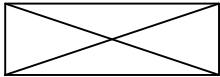
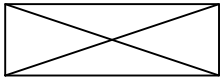
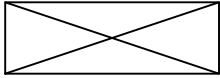
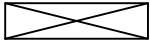
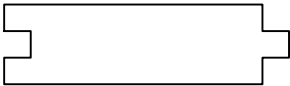
EL 6		1650x3900x143	1 pcs
EL 7		2950x640x143	1 pcs
EL 8.1 EL 8.2		1450x2500x143	2 pcs
EL 9		2500x2500x143	1 pcs
EL 10		1995x2500x134	1 pcs

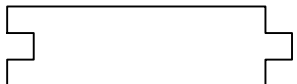

VS 1		2255x2090x82	1 pcs
VS 2		1820x2090x82	1 pcs
VS 3		1202x90x90	1 pcs
VS 4		3460x1855x82	1 pcs
VS 5		3460x1855x82	1 pcs



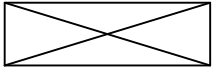
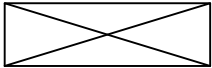
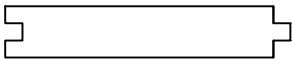

D1	 <p>Technical drawing of a four-pane window unit. The overall width is 2600 and the overall height is 1990. Each pane is 650 wide and 497.5 high. The panes are arranged in a 2x2 grid.</p>	2600x1990x100	1 pcs
D2/3	 <p>Technical drawing of two window units. The first unit is 1800 wide and 1990 high. The second unit is 890 wide and 1990 high. Both units have a 2x2 grid of panes.</p>	1800x1990x100 890x1990x100	2 pcs 1 pcs
W 1	 <p>Technical drawing of a square window frame with dimensions 890x890.</p>	890x890x80	1 pcs
W 2	 <p>Technical drawing of a square window frame with dimensions 560x560.</p>	560x560x82	1 pcs
D(I) 1	 <p>Technical drawing of a triangular window pane. The width is 900 and the height is 2000. The triangle is oriented with its base on the left and its apex on the right.</p>	900x2000x72	2 pcs

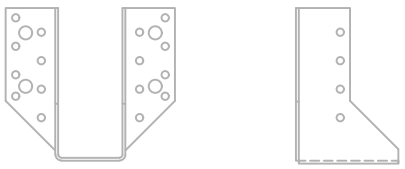

1.1		50x150x3120	2 pcs
1.2		50x150x2330	2 pcs
1.3		50x150x1950	2 pcs
1.4		50x150x3800	17 pcs
1.41		25x100x3800	4 pcs
1.5		28x120x2200	34 pcs

1.6		28x120x1820	20 pcs
1.7		28x120x3050	20 pcs
1.8		28x120x4940	14 pcs
1.9		6x120	100 pcs
1.10		4x45	580 pcs

2.1		44x144x3800	4 pcs
2.2		44x144x1890	2 pcs
2.3		18x100x1890	44 pcs
2.4		4x35	180 pcs

3.1		65x90 BMF105	30 pcs
3.2		BMF105	22 pcs
3.3		5x40	500 pcs

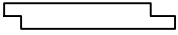
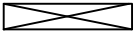
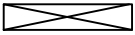
4.1		6x80	150 pcs
4.2		4x60	120 pcs
4.3		4,5x50	148 pcs
4.4		4x30	25 pcs

5.1		18x120x3900 18x120x2500	4 pcs 4 pcs
5.2		18x95x2500	2 pcs
5.3		18x90x2500 18x90x5000	4 pcs 2 pcs
5.4			set
5.5			set

Fundation

1:50

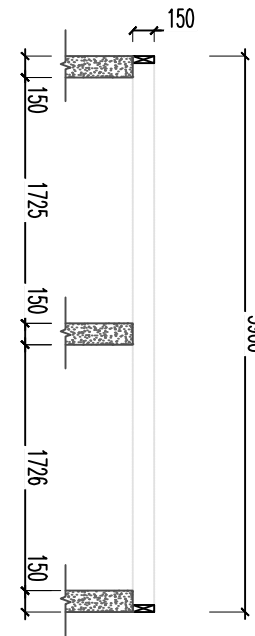
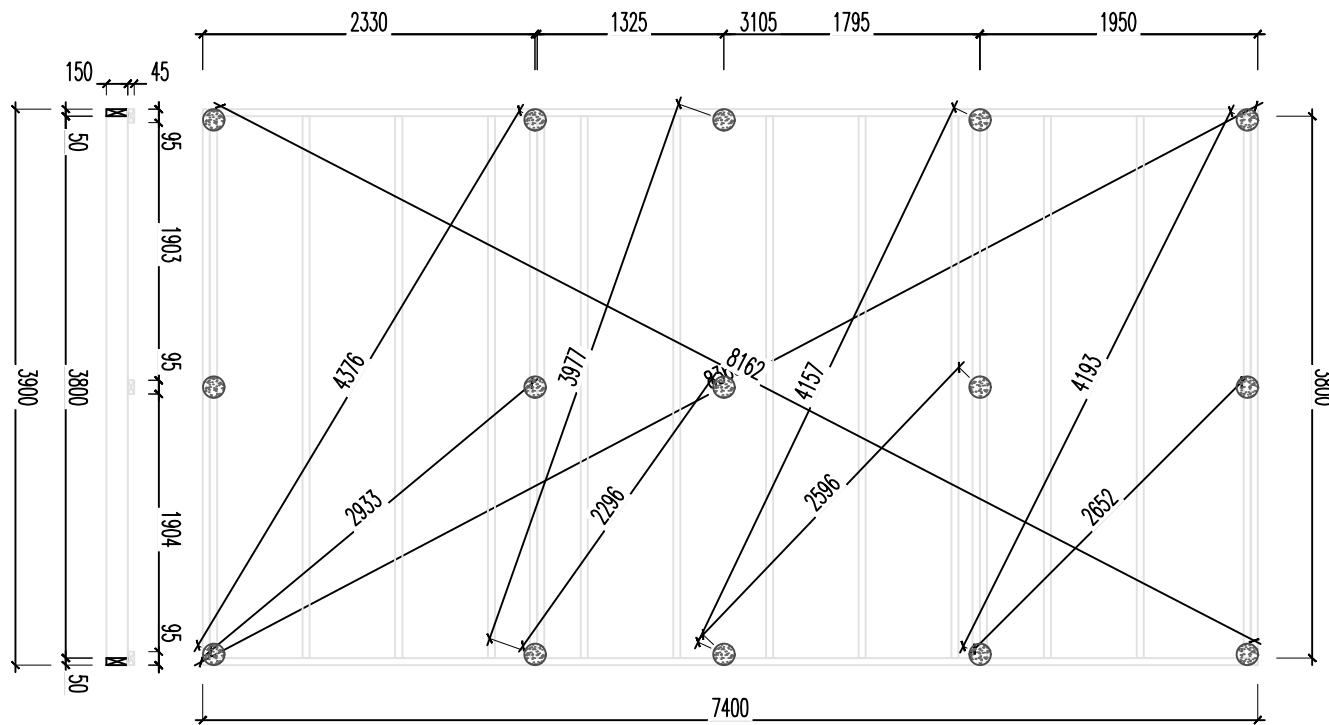
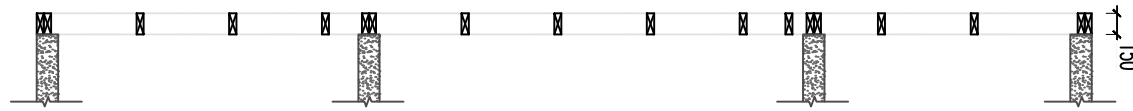

PROJECT	DRAWING		SCALE
MARIEDAL 2.0 30 m ²	Fundation layout		A3 1:50
CLIENT	PROJECT nr.	DATE	DRAWING nr.
	EP	03.08.2023	
	DRAFTED BY	CONTACT	
	Rain-Erik Jøe	56661911	
	ARCHITECT	SIGNATURE	

FLOOR ELEMENT

Material:

No.	Item	Quantity
1.1	50X150 beams 3120mm	2
1.2	50X150 beams 2330mm	2
1.3	50X150 beams 1950mm	2
1.4	50x150 cross beams 3800mm	17
1.9	Screw 6x120	100

Steps

For measurements and exact position of beams: look drawing 001 (mariedal_floor)

- Connect side beams with iron plates, mark the positions by the given measurements on a drawing 001
- Screw cross beams using two 6x120 screws on each side.

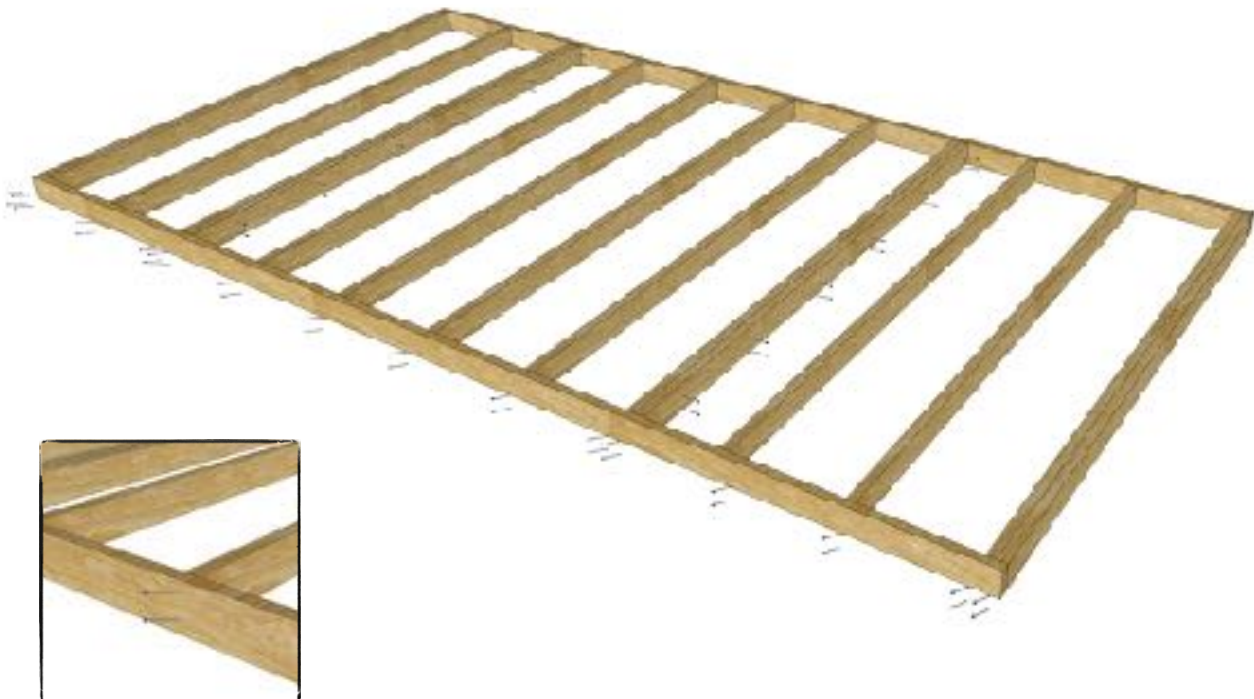

Floor 1:50

Loft floor 1:50

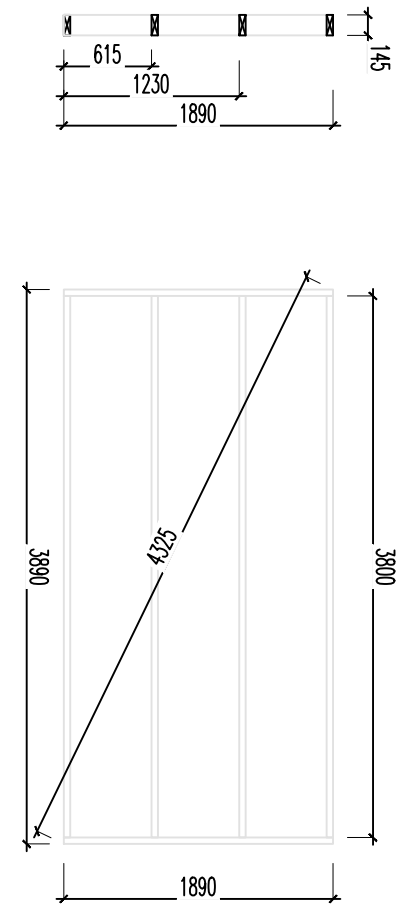
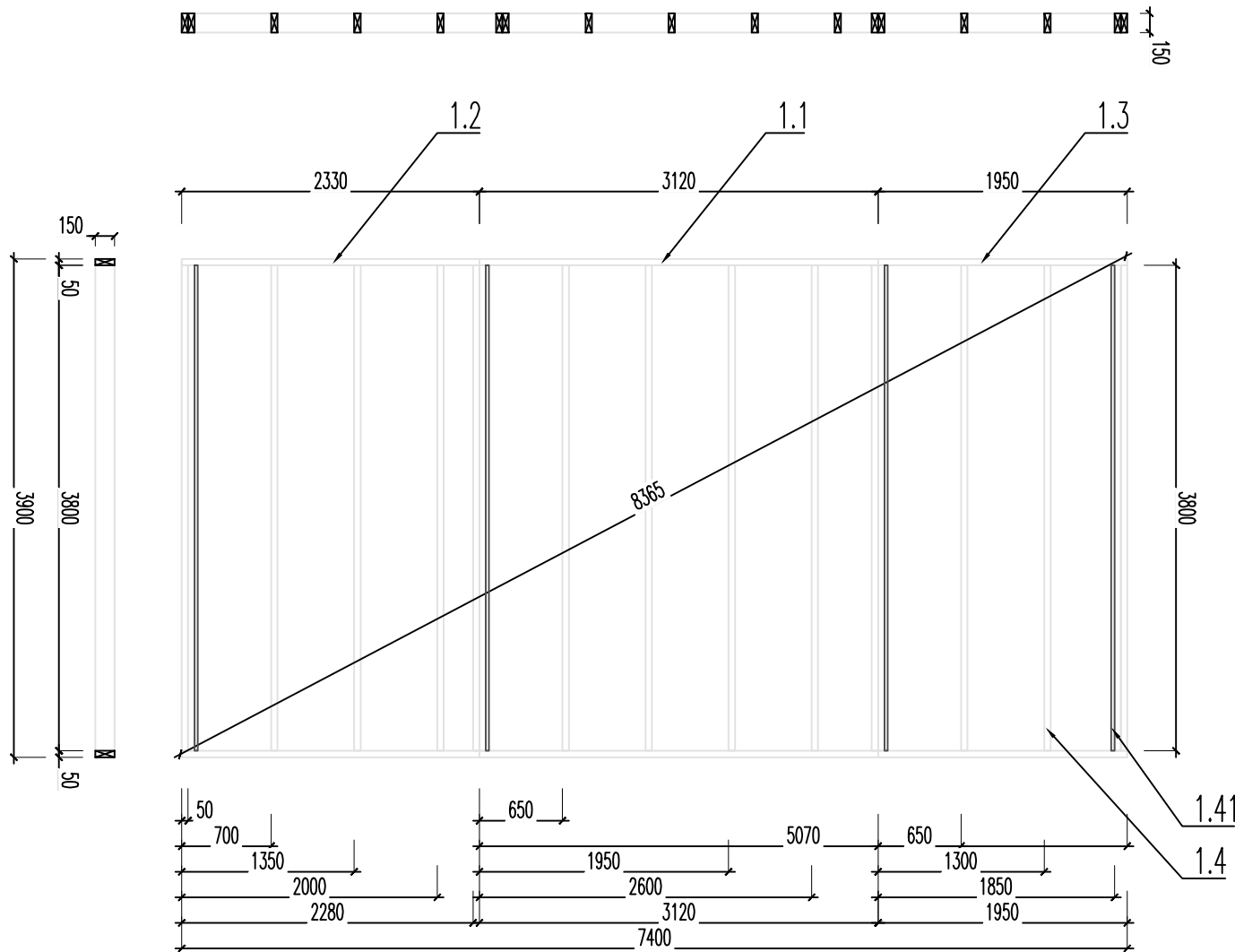

PROJECT	Floor framing 001		SCALE
MARIEDAL 2.0 30 m ²	PROJECT nr.	DATE 01.20.2020	A3 1:50
CLIENT	STATE EP	FAIL	DRAWING nr.
	DRAFTED BY Erik Jøe	CONTACT 56661911	
	ARCHITECT	SIGNATURE	

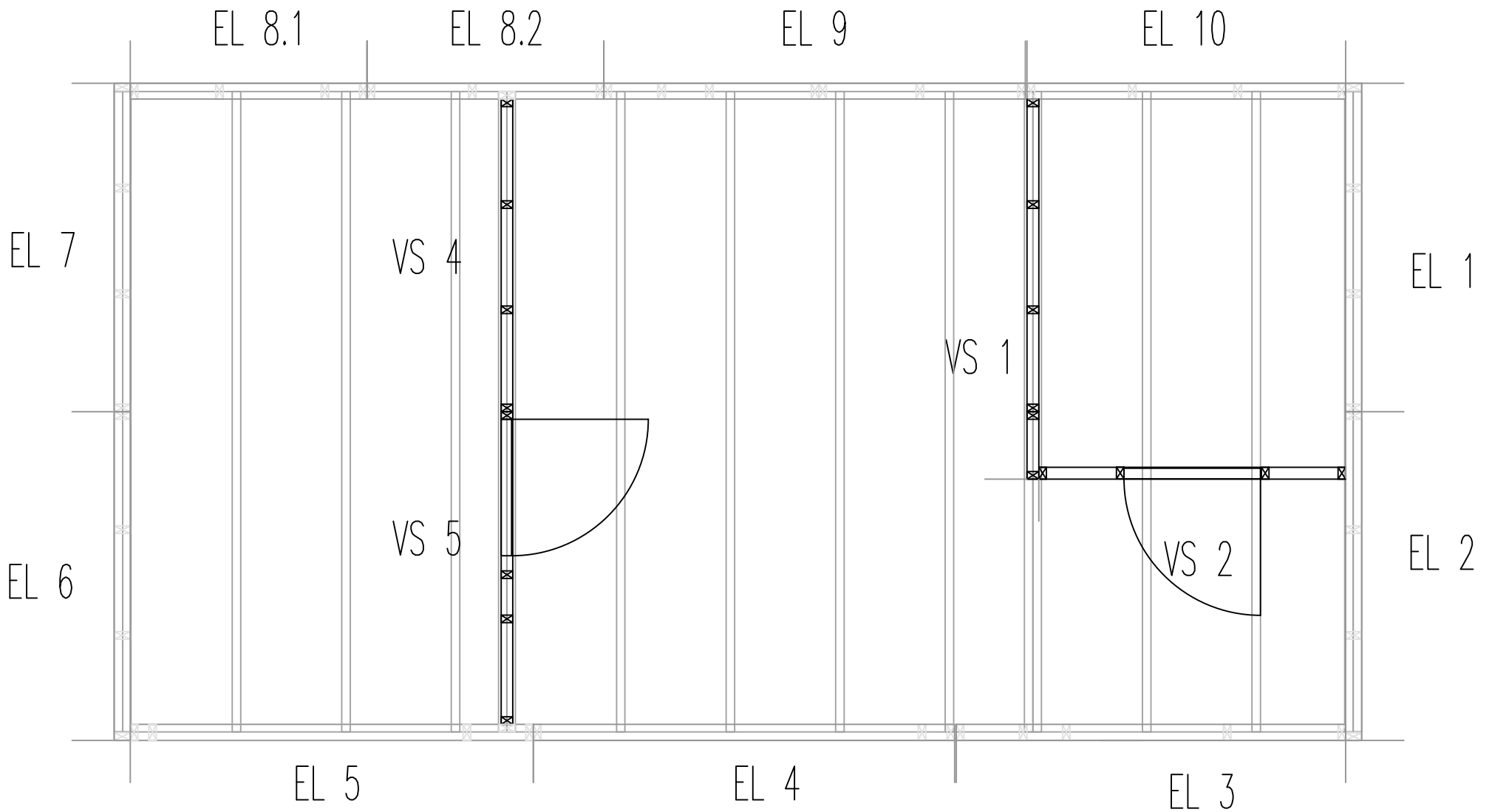

PROJECT	DRAWING		SCALE
MARIEDAL 2.0 30 m ²	Floorplan, elements 002		
CLIENT	PROJECT nr.	DATE	DRAWING nr.
	EP	01.04.2019	
	STATE	FAIL	
	DRAFTED BY	CONTACT	
	Rim-Erik Jøe	56651911	
	ARCHITECT	SIGNATURE	

WALL ELEMENTS

Material:

No.	Item	Quantity
EL 1-10	Wall elements (numbered)	11
4.1	Screws for joints, base and wall to wall 6x80	110

Steps

Elements by number

- Before installing remove transport blocks
- Connect wall element (numbered) side by side and to the wall element with 6x80 screws
- Positions of elements on drawing 002.

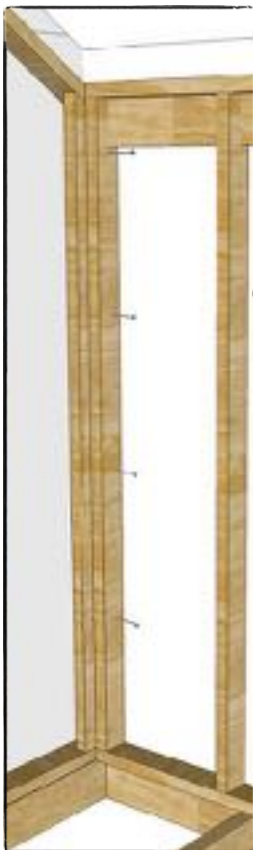

INNER-WALLS AND FLOOR

Material:

No.	Item	Quantity
VS-(1-2)	Inner-wall elements (room 1)	2
VS-(4-5)	Inner-wall elements (room 2)	2
4.1	Screws 6x80 (wall)	40
VS-3	Wall upstairs	1

Steps

For measurements and exact position of elements look drawing 002 (mariedal_floorplan)

- Connect side by side, screws s.500



CEILING PANEL

Material:

No.	Item	Quantity
2.1, 2.2	Loft floor element material: beams 2x1890, 4x3800	6
1.9	Screws for beams 6x120	16
4.1	Screws for connecting to wall 6x80	10
2.3	Floorboards 18x100x1860	44
2.5	Floorboard screws 4x45	180

Steps

Elements by number

- Screw cross beams using two 6x120 screws on each side.
- Positions on drawing 001
- Floorboard (cut to length at site)

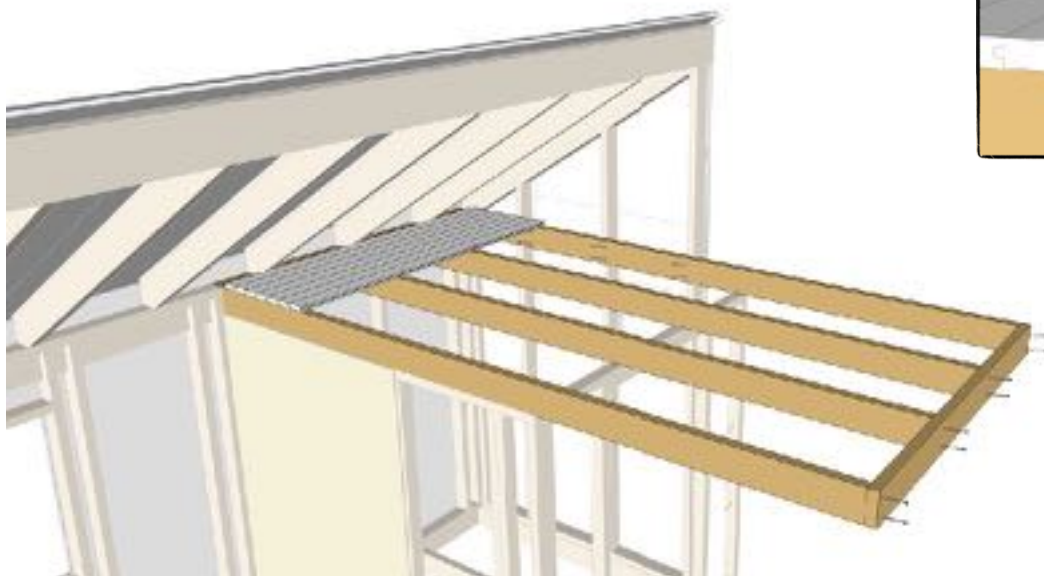

ROOF CONSTRUCTION

Material:

No.	Item	Quantity
LPT-01	Laminated beam 95x195x7400 (drawing 004)	1
PS-01	Rafters 45x145	4
PS-02	Rafters 45x145	22
PR-01	Distance	26
3.1	Rafter bracket	22
3.2	Angle brackets	30

Steps

Placement of the rafters

- Rafters jointed with brackets
- Positions and dimensions visible on drawing 004

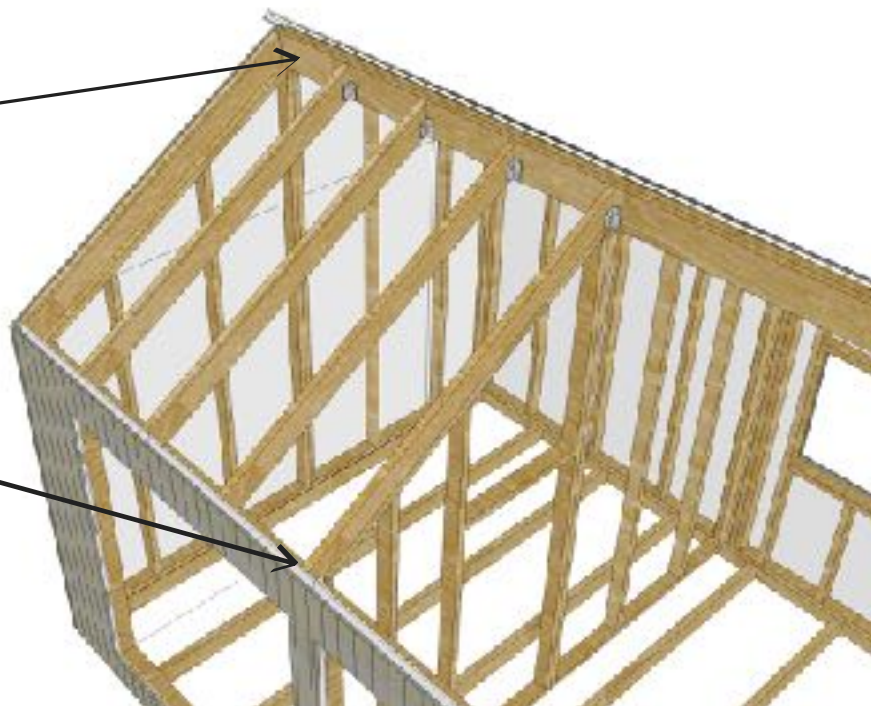

Rafter layout

1:50

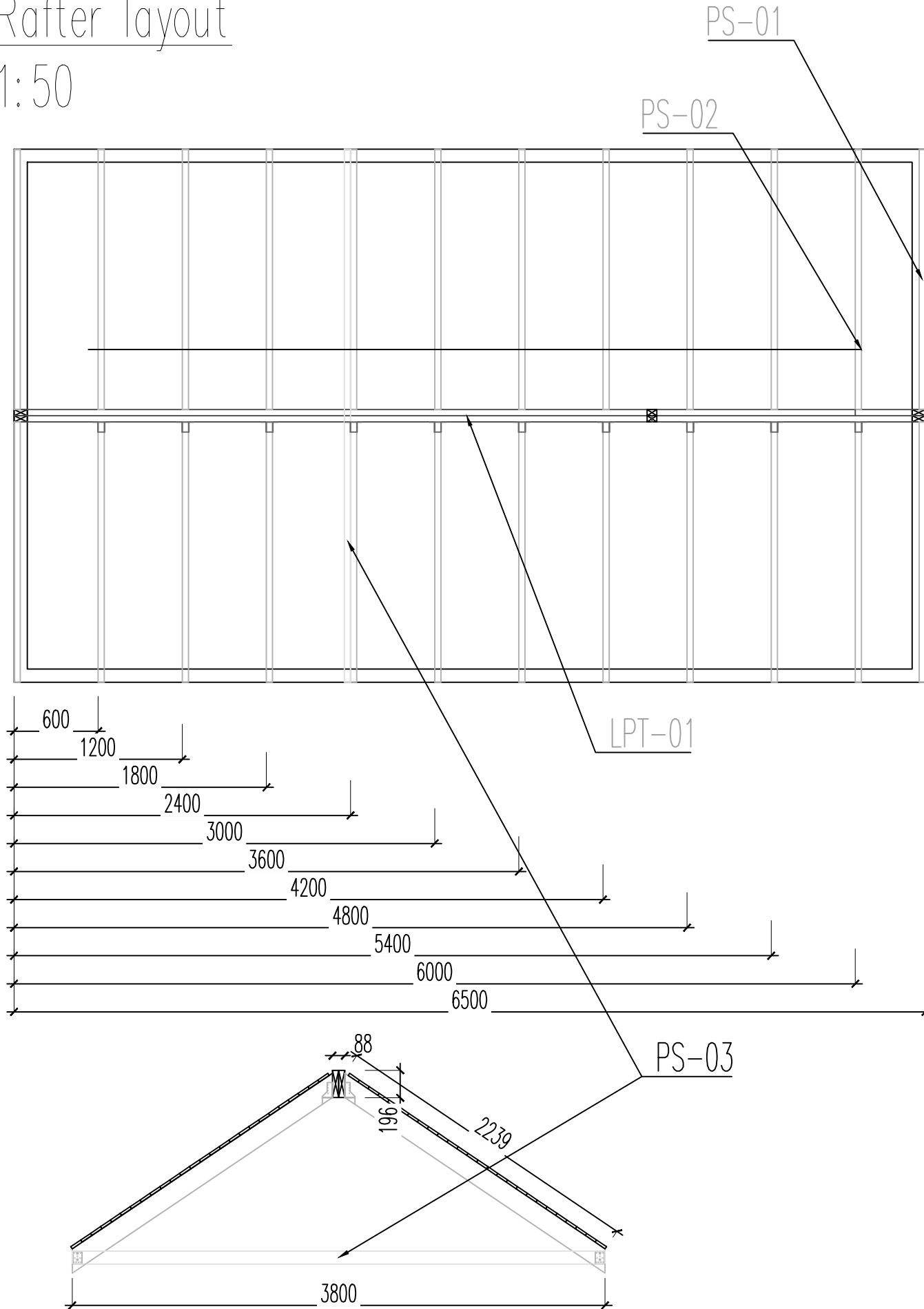

LPT -01 (beam)

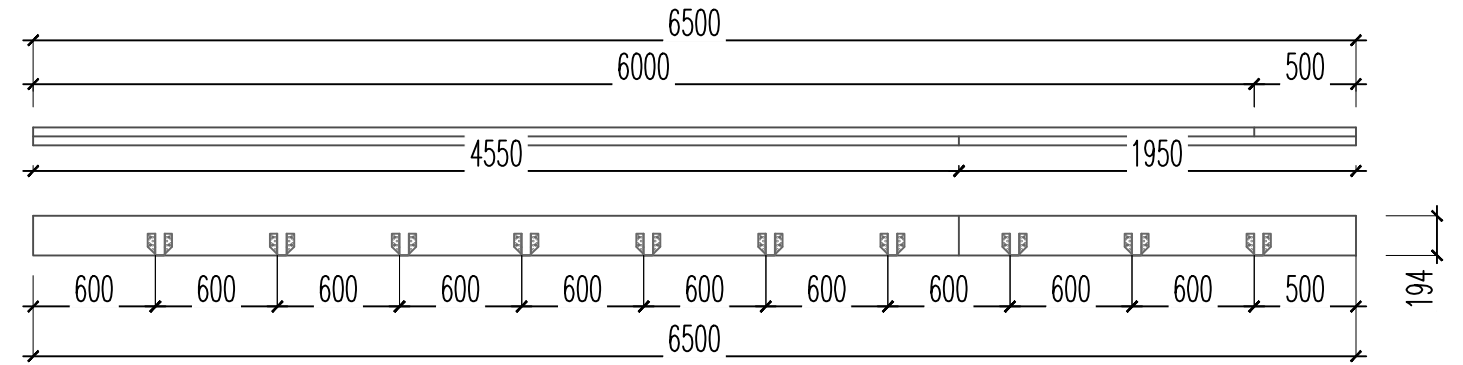

PS -01 (rafter 1)

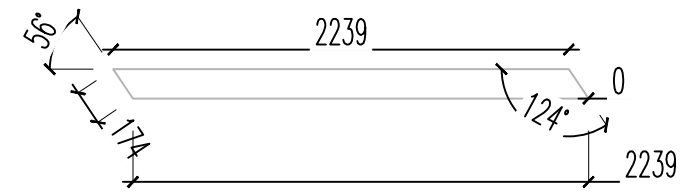

PS -02 (rafter 2)

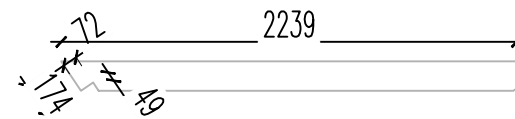

PS -03 (tie)

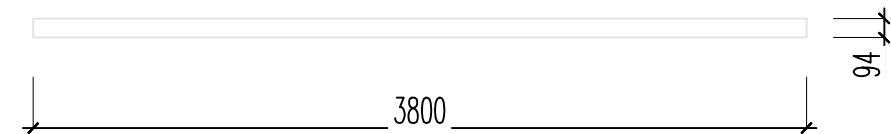

Roof construction 004						
LPT-01	LIIMPUITTALA	88x194	xxx	1		
PS-01	PUITSARIKAS	44x144	xxx	4		
PS-02	PUITSARIKAS	44x144	xxx	20		
MARIEDAL			Roof construction 004			
			01.04.2019			
			EP			
			Rein-Erik Jõe			
			56661911			

ROOFING

Material:

No.	Item	Quantity
KP 101-102	OSB 10mm, screws (4x35) 400 pcs	12
PR-01	Ventilation distance, screws (4x60) 120pcs	26
KP 181-183	OSB 18mm, screws (4x45) 400pcs	14
5.4	Edges (metal), screws 45pcs	set

Steps

- Layout of panels visible on drawing 006

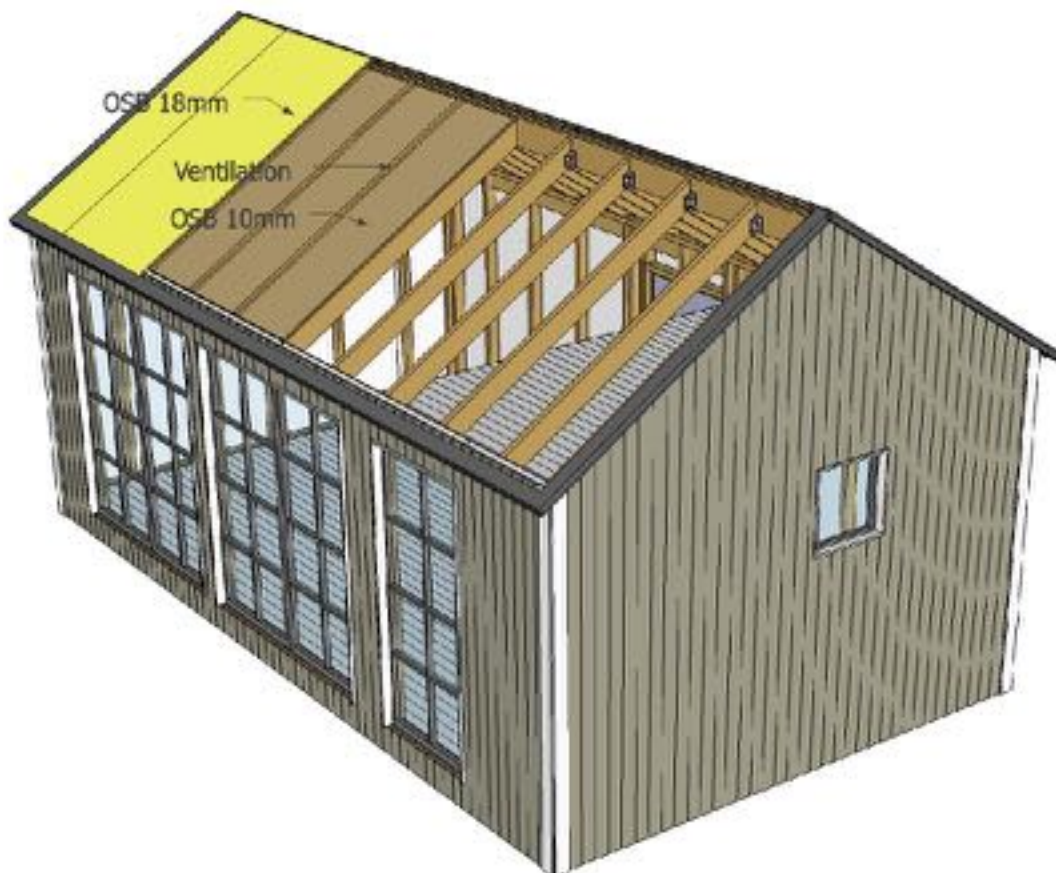

10mm OSB layout
1:50

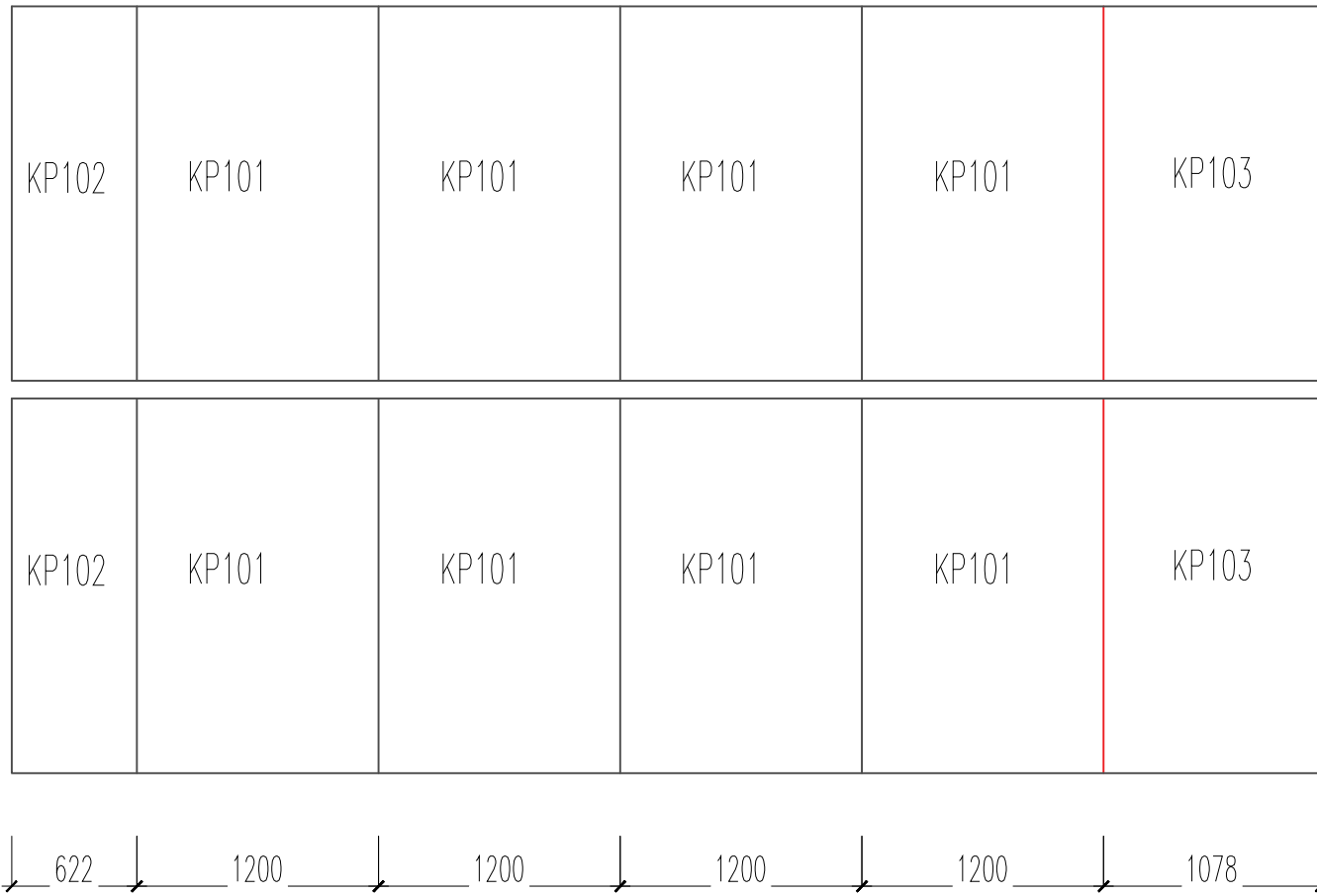

18mm OSB layout
1:50

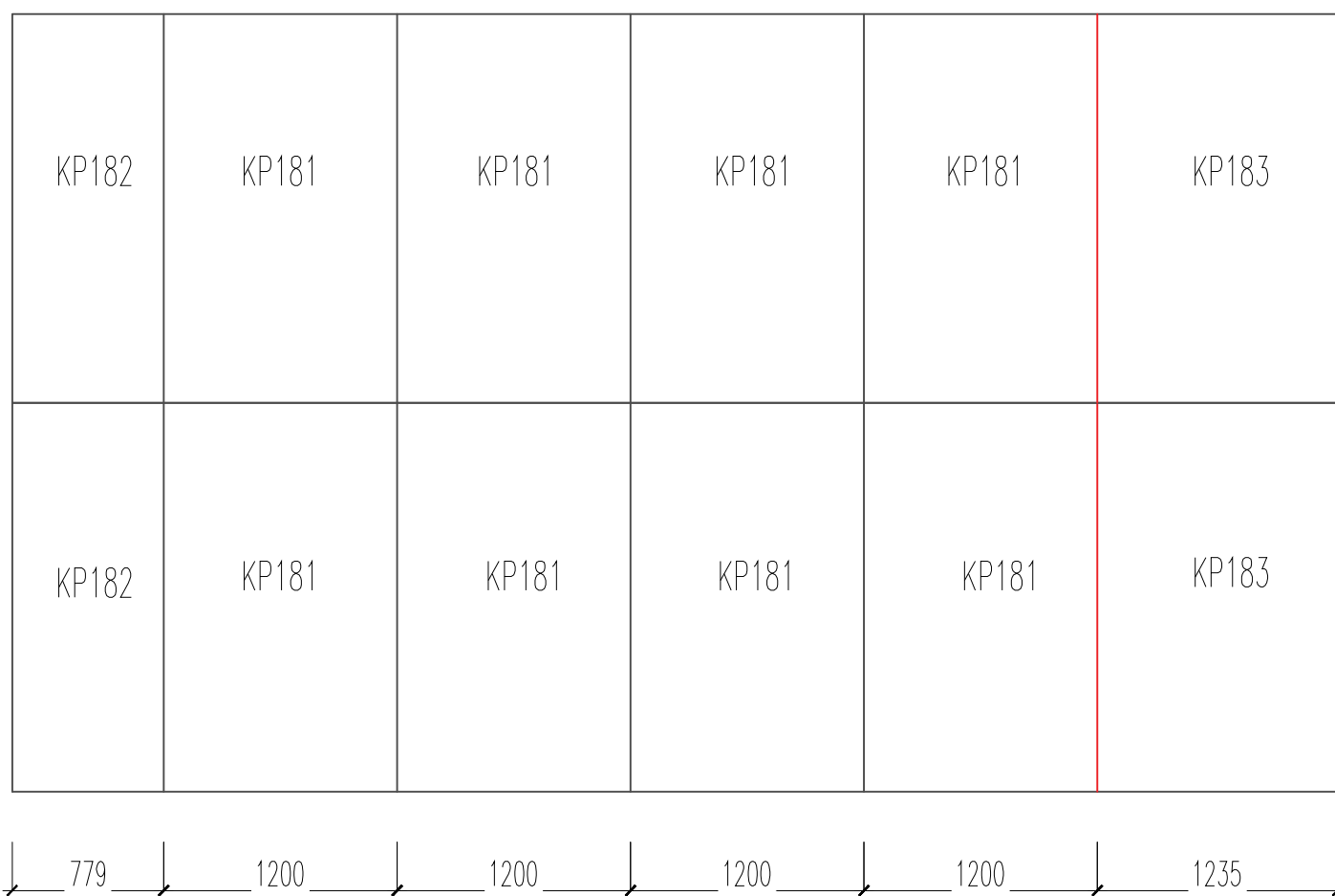

MARIEDAL	Roof panel layout 006		
		01.04.2019	
		56661911	

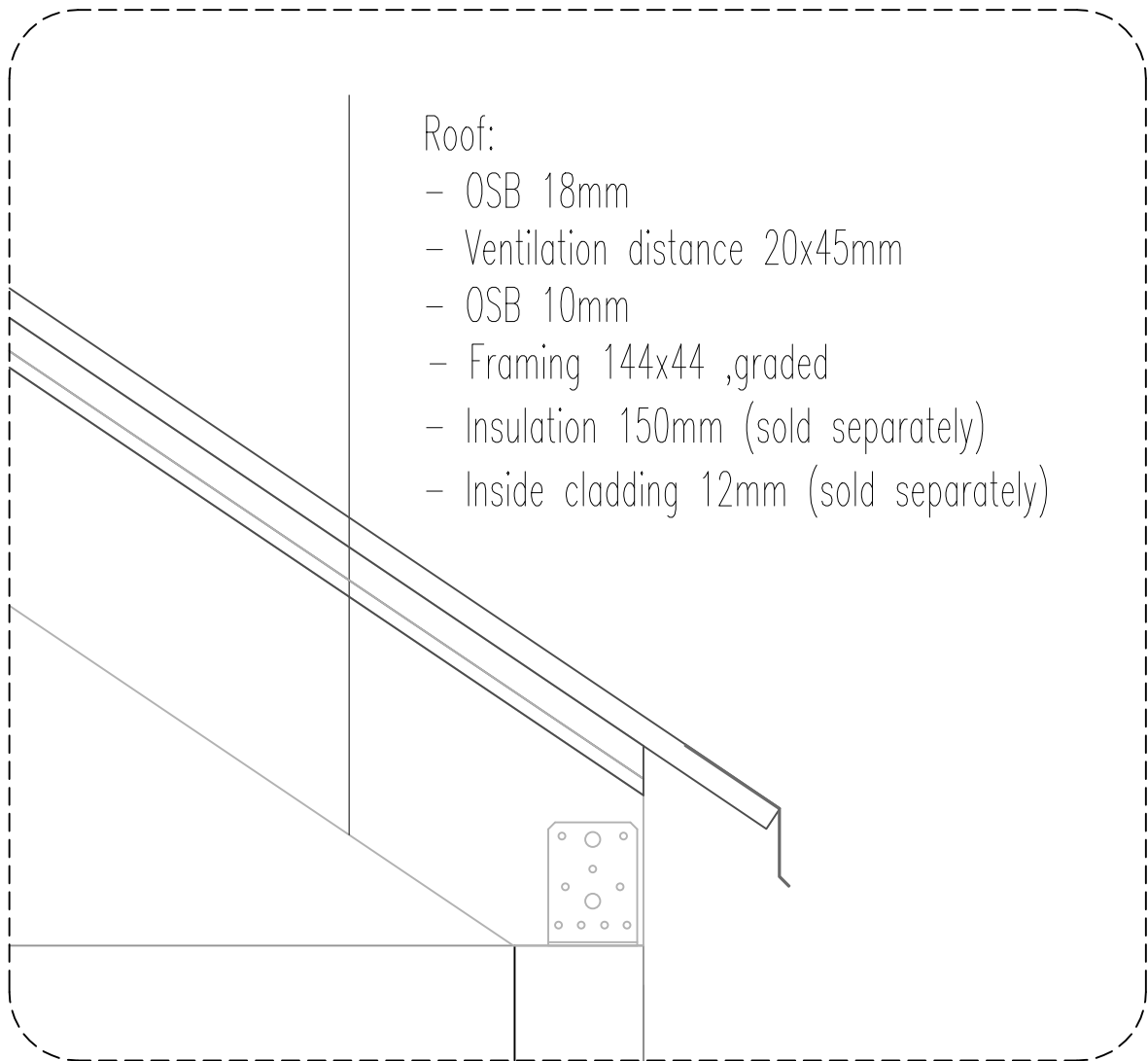

Roof:

- OSB 18mm
- Ventilation distance 20x45mm
- OSB 10mm
- Framing 144x44 ,graded
- Insulation 150mm (sold separately)
- Inside cladding 12mm (sold separately)

FLOOR AND DOOR!

Material:

No.	Item	Quantity
1.5	Floorboards 2,2m (screws 4x45 included)	34
1.6	Floorboards 1,85m (screws 4x45 included)	20
1.7	Floorboards 3,1m (screws 4x45 included)	20
1.8	Floorboards 4,95m (screws 4x45 included)	14
D(l) 1	Wooden door, package	2

Steps

- Floor installation plan drawing 003. Floor boards will be cut to length on site!
- Door installation manual, separately

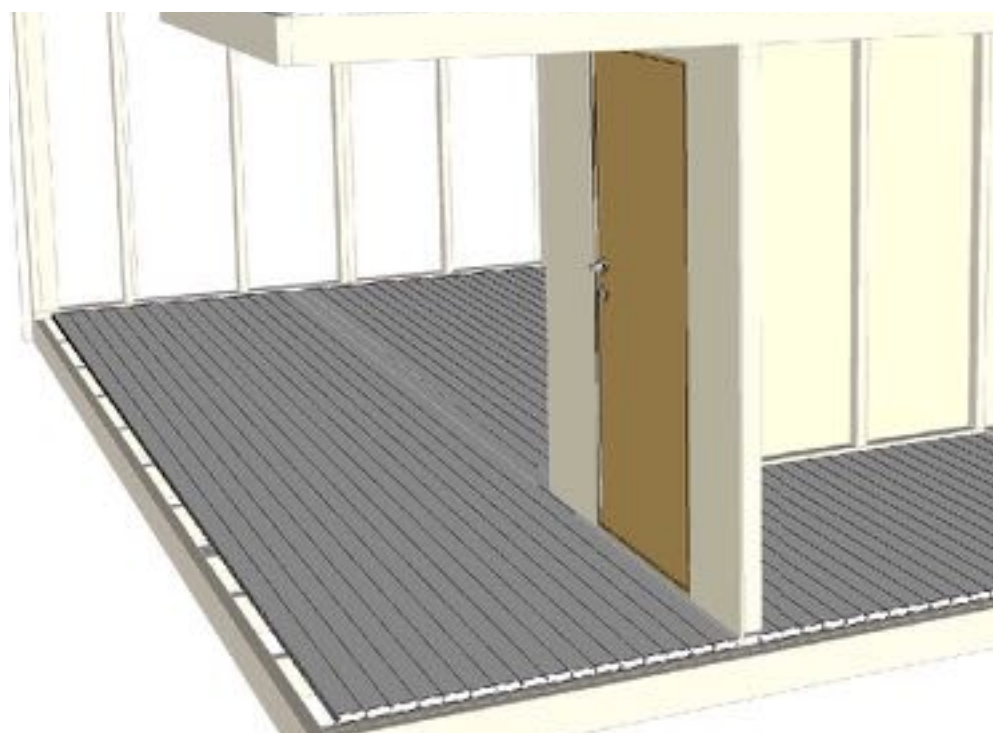

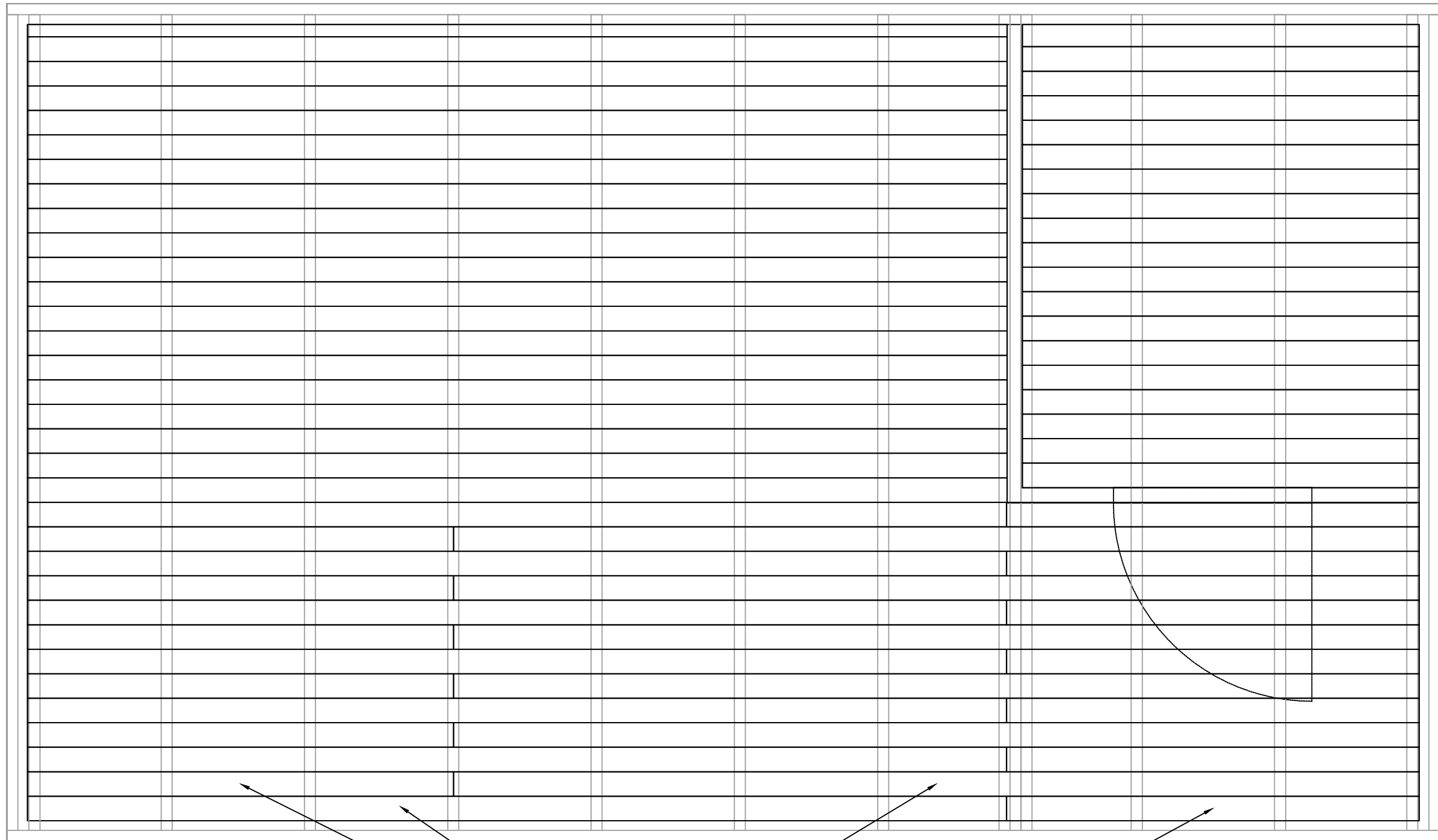

1.4

1.5

MARIEDAL	Floor 003	
		01.04.2019
	EP	
	Rein-Erik Jøe	56661911

FINISHING TOUCHES

Material:

No.	Item	Quantity
D1, D2	Doors	3
W1, W2	Windows	2
5,5	Window drip edge (fittings)	set
5.2	Cladding + overhead boards	4
5.3	Corner finishing boards	8

Steps

- Doors and windows installation manual separately.
- Finish, celebrate !!

